

Catalogue for Leathercraft Tools and Saddlery Equipment

Issue: january 2018

Heiko Kappey
Lederhandel - Sattlereibedarf
MAUTHE-Industriewerkzeuge
Achardstr. 10

D-31319 Sehnde / Hannover

Telefon: 05138 / 7099-91
Telefax: 05138 / 7099-93
email: info@kappey.de
Internet: www.kappey.de

Banking details:

| | |
|--------------------|-----------------------------|
| Postbank Hannover: | 5408 00-309 |
| Bankleitzahl: | 250 100 30 |
| BIC No: | PB NK DE FF 250 |
| IBAN: | DE22 2501 0030 0540 8003 09 |

| | |
|---------------------|-----------------------------|
| Sparkasse Hannover: | 589 683 |
| Bankleitzahl: | 250 501 80 |
| BIC No: | SPKHDE2HXXX |
| IBAN: | DE53 2505 0180 0000 5896 83 |

Please note: Pictures and drawings in this catalogue can differ from articles actually delivered. They are used solely to identify articles and are therefore not detailed descriptions.

Contents

| Grp. No. | Article groups | page |
|----------|--|------|
| 010 | Sets | 03 |
| 011 | Sharpening services | 04 |
| 020 | Splitting, shaving and cutting devices | 04 |
| 022 | Electrical Machinery for stitching, shaving and splitting | 05 |
| 030 | Knives | 06 |
| 040 | Shavers, skivers and edge tools | 10 |
| 050 | Markers, Racers and Groovers | 11 |
| 060 | Rulers and Compass Tools | 12 |
| 070 | Decoration Tools and Loop Wedges | 13 |
| 071 | Company Stamps and Saddle Markings | 19 |
| 080 | Strap End Chisels | 20 |
| 090 | Hole Punches | 21 |
| 100 | Hole punch pliers | 25 |
| 120 | Leather- and upholstery pliers & pincers | 26 |
| 130 | General pliers & pincers | 27 |
| 140 | Scissors | 28 |
| 150 | Useful general tools | 29 |
| 151 | Elektric tools | 29 |
| 155 | Saddle and upholstery tools | 30 |
| 160 | Hammers, Mallets | 31 |
| 170 | Pricking tools | 33 |
| 180 | Awls | 34 |
| 190 | Hafts | 36 |
| 200 | Prickers | 37 |
| 210 | Staple- and stretching tools & removers | 38 |
| 211 | Air pressure Staplers | 38 |
| 230 | Needles & Pins | 39 |
| 240 | Sharpening tools, whetstones and machinery | 42 |
| 245 | Rough scratchers & files | 42 |
| 260 | Glues, dyes, wachs, pitch, grease, oil, soap | 43 |
| 270 | Health & safety | 48 |
| 280 | Containers, cutting and punching Boards | 48 |
| 290 | Nails, rivets, eylets and snaps | 50 |
| 291 | Riveting tools and machinery | 56 |
| 310 | Threads & yarn | 59 |
| 320 | Books on leathercraft & saddlery | 64 |
| 330 | Zipps, webbing, tapes, leathers and upholstery materials (Neopren, Felt, stuffing etc.) | 65 |

Supplements: -MAUTHE-Catalogue
-OSBORNE-Catalogue
-Buckles & Fittings.



Saddlemakers Starter Kit

Includes: 1 French Knife

1 Creaser

1 Falzbein

1 Sharp Awl & Haft (changeable)

1 Stabbing Awl & Haft (changeable)

2 Shavers (1, 3 + 2, 4) & 1 Haft

3 Threads (white, brown, black)

1 Package (25 pieces) Harness Needles No. 1

1 Package Needles sorted (6 different types)

1 Threadwachs

Art.No. 9999

€ 132,94 + VAT

Kombi-Kit

**1 Book "The Art of Handsewing Leather" and 1 Kit:
„Das Sattlersäckchen“ for leatherworks as kit**

Art.No. 9998

€ 32,00 + VAT

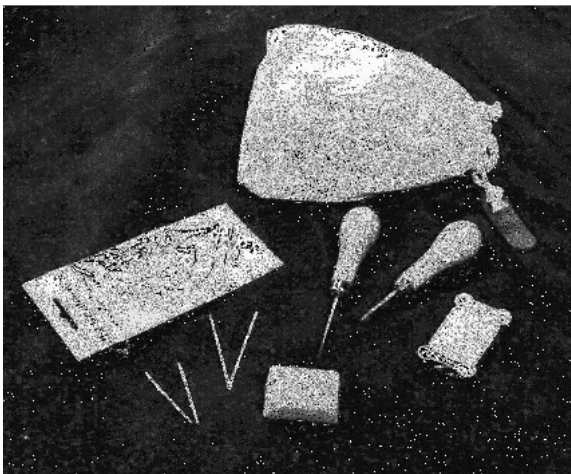

Das Sattlersäckchen

Sewing-kit „Das Sattlersäckchen“

1 Sharp Awl & Haft

1 Stabbing Awl & Haft

1 Thread (white)

2 small and 2 big Harnessneedles

1 Package Needles sorted (6 different types)

1 Threadwachs





Art. Nr. 3251



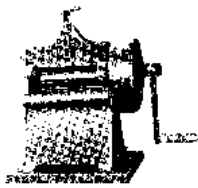
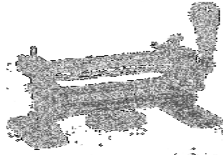

€22,80 + VAT

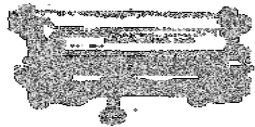



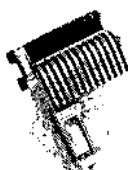
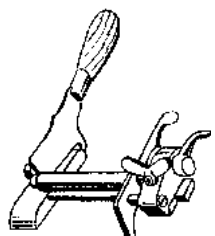
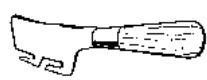

| Art. N0. | Article name | Prices ex VAT. (€) | |
|------------|---|--------------------|-------|
| 011 | Sharpening services (Scissors, Shaves & Knives etc.) | | |
| 000001 | Punch round, sharpening | netto | 1,50 |
| 000002 | Oval punch , sharpening | netto | 2,50 |
| 000003 | Crew- and Trace end punch sharpening | netto | 4,00 |
| 000004 | Strap end chisel sharpening | netto | 3,00 |
| 000010 | French edge shave. sharpening, cost per edge | netto | 1,50 |
| 000010.H | Round edge shave sharpening | netto | 3,00 |
| 000011 | Scissors sharpening and adjusting per inch | netto | 0,70 |
| 000016 | Shortblade A (f.e. 190320/21) sharpening | netto | 3,00 |
| 000017 | Shortblade B (f.e. 51)sharpening | netto | 3,00 |
| 000018 | Handknife short, sharpening | netto | 3,00 |
| 000019 | Shave-and shomakerknife sharpening | netto | 4,00 |
| 000020 | Handknife sharpening up to 5" | netto | 4,58 |
| 000021 | Handknife sharpening ov. 5"per inchl (2,54 cm) | netto | 0,80 |
| 000030 | Round knife/Head knife sharpening | netto | 10,00 |
| 000035 | French pattern knife sharpening | netto | 5,37 |
| 000036 | Spare knife for strap cutter sharpening | netto | 5,11 |
| 000041 | Blade for splitting mach.No.055 sharpening | netto | 10,00 |
| 000041.84 | Blade for splitting mach.No.84 sharpening | netto | 15,00 |
| 000041.86 | Blade for splitting mach.No.86 sharpening | netto | 15,00 |
| 0000411 | Knife for Leathersplitter sharpening Preis /mm | netto | 0,06 |
| 000042 | Ridge plane scharpening | netto | 4,00 |

Other sharpening services on demand.

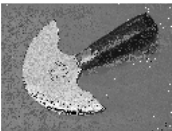
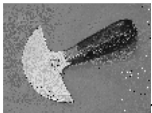
020 Splitting-,shaving- and cutting devices







| | | | | |
|------------------------------|---|-------|------------------|---|
| 116B | Splitting machine with winding lever Knifewidth c. 15 cm | netto | 2.995,00 |  |
| 0051 0051M | Splitting machine "J. Dixon", (mechanical) Knifewidth c. 15 cm Spare blade c. 15 cm | | 997,92 153,20 |  |
| 0055 0055-M | Splitting machine, "Craftool", (mechanical) Knifewidth 13 cm Spare blade | | 205,82 56,48 |  |
| 86 86-B | Splitting machine "Osborne", (mechanical) Knifewidht 15,2 cm Spare blade | | 765,80 397,80 |  |
| 86-A | Splitting machine "Osborne", (mechanical) extra clever for thickness adjustments Knifewidth 15,2 cm | | 870,00 |  |
| 84 | Splitting machine "Osborne", (mechanical) Adjustable lever for thickness and pressure Knifewidth 20,32 cm | | 1021,20 |  |

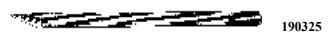
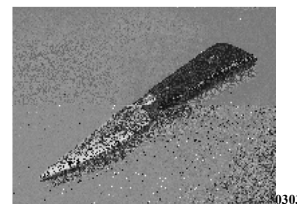



| Art. No. | Article name | Prices ex VAT. (€) |
|---|--|---|
| 020 Splitting-, shaving- and cutting devices (continued) | | |
| Strap- and stripcutters | | |
| LF311000 | Jerry`s Stripper, lace cutter, fringe cutter | 90,95 |
| LF311000.K | Spare Blades for lace cutter , 5 Stück | 5,18 |
| | |  |
| | | LF31100 |
| 0101 | Strap cutter (mechanical), "BLANCHARD" up to 10 cm scale | 436,08 |
| 0102 | up to 15 cm scale | 451,96 |
| | Complete brass,fixable roller Knife included | |
| 0131 | Spare blade for strap cutter | 65,80 |
| | |  |
| | | 0101 + 0102 |
| 0102OLE | strap cutter up to 15 cm scale | 250,00 |
| 0111 | Strap cutter (mechanical) up to 10 cm scale, simple design | 263,20 |
| | Including knife | |
| 0132 | Spare blade for strap cutter (0111) | 29,50 |
| | |  |
| | | 0131 |
| 51 | Draw gauge "Osborne", with handle and adjustable leading for straps | 99,60 |
| 51-1/2B | Spare blade | 12,80 |
| | |  |
| | | 51 |
| 0141 | Strap Cutter, wood | 35,00 |
| 0141 E | Spare blades 5 pcs. | 5,60 |
| Washer cutters | | |
| 0151 | Washer cutter with swivel handle "BLANCHARD" max. d= 400 mm | 172,26 |
| | |  |
| | | 0151 |
| 0161 | Washer cutter, simple "BLANCHARD" max. d= 200 mm | 121,82 |
| 0162 | max. d= 400 mm | 129,35 |
| 0171 | Spare blades for Art.No. 0151 – 0162 | 15,82 |
| | |  |
| | | 0161- 0162 |
| W736 | Double washer cutter with two blades (second blade extractable) .30 cm scale | 114,00 |
| W736 | .33 Spare Blade for W736.30 | 24,06 |
| 022 | Elektr. Machines for stitching,shaving,splitting We supply for Müller&Kurth, A-Z, MAD0 and more. | |

| Art. No. | Article name | Prices exVAT. (€) | |
|-------------------|--|-------------------|---|
| 030 Knives | | | |
| | Round knife "BLANCHARD, Paris" | |  |
| 0204 | No. 4 125 mm | 69,28 | |
| 0205 | No. 5 150 mm | 85,36 | |
| 0206 | No. 6 175 mm | 106,96 | |
| 0207 | No. 7 200 mm | 100,26 | |
| 0204H | Spare handle for round knife No. 4 | 5,10 | |
| 0205H | Spare handle for round knife No. 5 - No. 7 | 5,10 | |
| | | |  |
| 70 | Round knife, Osborne, 127 mm | 89,80 |  |
| 71 | Doublehead knife, Osborne, 118 mm | 83,80 |  |
| 0216 | Round knife, Don Carlos "Pik As" 155 mm | 58,34 | |
| 0251 | French pattern knife "BLANCHARD, Paris" | 63,60 | |
| 0251.S | French pattern knife "Solingen" | 24,66 | |
| 0252 | French pattern knife, Don Carlos "Pik As" | 40,71 |  |
| 000280 | Paring knife , "Pik As", 13 cm | 25,74 |  |
| | Paring knife "BLANCHARD, Paris" | | |
| 0281 | No. 1 44 mm wide | 42,82 | |
| 0282 | No. 2 48 mm wide | 41,18 | |
| 0283 | No. 3 54 mm wide | 41,18 |  |
| 0302 | Handknife, winged, 13 cm, " Pik As" | 25,74 |  |

| Art. No. | Article name | prices ex VAT. (€) |
|---------------------------|---|--------------------|
| 030 Knives (cont.) | | |
| 0303 | Handknife, pointed, 12 cm, " Pik As" | 25,74 |
| 0304 | Handknife, hawkbill blade, 8 cm, " Pik As" | 27,39 |
| 0307.S | Leatherknife, strength 1, 9 mm | 10,00 |
| 0309 | Workknife, (Bookbinders) 55 mm blade | 6,00 |
| 0310 | 100 mm blade | 8,25 |
| 190345 | MAUTHE cleaning knife | 5,00 |
| 190350 | MAUTHE Flensing knife, 10 cm blade | 9,20 |
| 190351 | MAUTHE Flensing knife, 15 cm blade | 12,20 |
| 190352 | MAUTHE Flensing knife, 20 cm blade | 14,80 |
| 190353 | MAUTHE Flensing knife, 25 cm blade | 21,26 |
| 190354 | MAUTHE Flensing knife, 31 cm blade | 29,40 |
| 0320 | Pattern knife, "TINA"Brand Including adjustable blade, 13 mm | 52,80 |
| 0321 | Including adjustable blade, 24 mm | 51,00 |
| 0330 | Spare blade , 13 mm | 22,00 |
| 0331 | Spare blade , 24 mm | 22,00 |
| 190301 | Pattern knife , MAUTHE Including adjustable blade, 14 mm | 13,98 |
| 190303 | Including adjustable blade, 25 mm | 15,00 |
| 190302 | Spare blade, 14 mm | 6,34 |
| 190304 | Spare blade, 25 mm | 6,87 |
| 190308 | MAUTHE Shoemaker`s knife, | 6,66 |
| 190313 | MAUTHE Shoemaker`s knife, 22 x 270 mm conical | 16,00 |
| 190318 | MAUTHE Incising knife, 22 x 300 mm | 16,00 |
| 190325 | MAUTHE Pattern knife 10 x 230 mm | 26,00 |

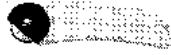

| Art. No. | Artivle name | Prices ex VAT. (€) | |
|---------------------------|--|--------------------|---|
| 030 Knives (cont.) | | | |
| 190309 | Shomaker`s knife bent | 7,83 | |
| 190309 L | Shoemaker`s knife, left bent | 7,91 | |
| 190310 | MAUTHE Metal-bladehandle For different pattern knives | 17,95 |  190310 |
| 190331 | Metal-bladehandle with prick | 23,20 |  190331 |
| 190331A | Spare prick for No. 190331 | 6,30 | |
| 190332 | Metal-bladehandler without prick | 16,30 |  190332 |
| 190320 | Blade for 190332, 140 x 6 mm, lentilshaped steel <i>temporarily out of stock</i> | | |
| 190321 | Blade for 190332, 150 x 6 mm, RC 59 | 2,10 |  190321 |
| 190333 | Spare blades for No`s. 190331 und 190332 | 6,30 | |
| Ti210 new: | Pattern knife TINA 210 26 cm length, 12 mm wide | 33,00 | |
| Ti250G | Pattern knife TINA 250G 23 cm length, 23 mm wide | 33,00 | |
| Ti270 | Shoemaker`s knife TINA 270, slightly bent | 68,00 | |
| Ti270G | Shoemaker`s knife TINA 270G, straight | 70,00 | |
| TIN0352 | Trimming knife "Tina" | 91,00 | |
| 190334 | Pattern-knifehandle with prick 1 | 19,20 |  190334 |
| 190337 | Martor Simplasto-bladehandle incl. blade | 6,44 | |
| 190338 | Spare Blades 10 pcs. | 3,78 | |
| 460 | Bladehandle "Osborne" | 40,40 |  460 |
| 0350 | Trimming knife "BLANCHARD, Paris" with exchangeable blade | 107,60 |  0350-0351 |
| 0351 | Spare Blade for No. 0350 | 52,22 | |

| Art. No. | Article name | Prices ex VAT. (€) | |
|---------------------------|--|--------------------|---|
| 030 Knives (cont.) | | | |
| 0339 | Cutter, 9 mm breakable blade | 0,43 |  |
| 0340 | Martor-Cutter (breakable blade) | | |
| | .09 9 mm blade | 2,02 |  0340.09 |
| 0340 | .09.k Spare blades 9 mm, 10 Stück | 1,95 | |
| 0340 | .10.k Spare blades 9 mm, 10 Stück | 2,20 | |
| 0340 | Martor-Cutter (breakable blade) | | |
| | .18 18 mm blade | 2,66 |  0340.18 |
| | .18.k Spare blades 18 mm, 10 Stück | 4,04 | |
| 0341 | OLFA Cutter (breakable blade) | | |
| | .18 Cutter Olfa, 18 mm | 10,64 | |
| | .18.k olfa Spare blades 18 mm, 10 Stück | 6,14 | |
| | .18M Cutter OlfaNT, 18 mm, metal | 10,36 | |
| | .25 Cutter Olfa 25 mm | 15,78 | |
| | .25.k Breakable blades 25 mm, 5 Stück | 6,10 | |
| D2000 | Bladehandle „Delphin“, incl. Quiver | 15,54 |  |
| D2000K | Bladehandle „Delphin“ plastic | 6,85 | |
| 0335 | Rolly Roundblade | 4,52 | |
| 0336 | Rollex Roundblade | 7,46 |  |
| 0333 | OLFA Roundblade cutter „RTY-2DX“ | 23,04 | |
| 0333. | RK Spare blade 45 mm, roundblade | 6,38 | |
| 0333. | WK Spare blade 45 mm, wavecut-blade | 7,14 | |
| 0333. | ZK Spare blade 45 mm, zickzack-blade | 7,14 | |
| | M Olfa Roundblade cutter NT, metal, 45 mm | 20,70 |  0333 |
| 0334 | OLFA-Roundblade cutter RTY-3/G, 60 mm Klinge | 24,16 | |
| 0334.K | Spare blade für OLFA RTY-3/G, 60 mm | 8,55 | |
| PRC-2 Olfa | Perforationblade, round 18 mm | 7,84 | |
| PRB18-2 Olfa | Spare blade | 4,84 | |
| 190340 | Trimknife 190 (foldknife) | 33,34 | |
| 190341 | Trimknife (foldknife) | 6,10 | |
| W0103.0 | Hookblade 55 mm, 10 Stück | 1,94 | |
| W00503.0 | Trapezoid-blade, 10 Stück | 2,07 | |
| Martor 52.70 | Allfit-Trapezoid-blades, ice-tempered 10 Stück | 4,70 | |

Custom knives after your design or sample

| | | |
|--------|-------------------------------------|-----------------|
| 190500 | Customized Circle knives to pattern | Price on demand |
| 190501 | Customized knives to pattern | Price on demand |
| 190502 | Customized machinestamp knives | Price on demand |

| Art. No. | Article name | Prices ex VAT. (€) |
|--|---|--------------------|
| 040 Shavers, skivers and edge tools | | |
| | Edge shave. "J. Dixon" | |
| 0355.1 | No. 1 | 38,60 |
| 0355.2 | No. 2 | 38,60 |
| 0355.3 | No. 3 | 38,60 |
| 0355.4 | No. 4 | 38,60 |
| 0355.5 | No. 5 | 38,60 |
| 0355.6 | No. 6 | 38,60 |
| | Hollow edge shaves similar "J. Dixon" | |
| 0361-LI | Gr. Nr. 1, 1,0 mm | 39,82 |
| 0362-LI | Gr. Nr. 2, 1,5 mm | 39,82 |
| 0363-LI | Gr. Nr. 3, 2,0 mm | 39,82 |
| 0364-LI | Gr. Nr. 4, 2,5 mm | 39,82 |
| 0365-LI | Gr. Nr. 5, 3,0 mm | 39,82 |
| 0366-LI | Gr. Nr. 6, 3,5 mm | 39,82 |
| 0367-LI | Gr. Nr. 7, 4,0 mm | 44,00 |
| 0368-LI | Gr. Nr. 8, 4,5 mm | 44,00 |
| 0373 | Edge shave No. 1 and 3, exchangeable tool | 17,94 |
| 0373.1/1 | Edge shave No. 1 and 1, exchangeable tool | 17,94 |
| 0373.1/2 | Edge shave No. 1 and 2, exchangeable tool | 17,94 |
| 0374 | Edge shave No. 2 and 4, exchangeable tool | 17,94 |
| 0374-H | Spare haft for Art.No's. 0373-0374 | 1,20 |
| | Edge shave "BLANCHARD, Paris" | |
| 0371 | No. 1 and 2, exchangeable tool | 47,28 |
| 0372 | No. 3 and 4, exchangeable tool | 43,00 |
| | Edge shave "BLANCHARD, Paris" | |
| 0380 | No. 0, fixed tool | 30,84 |
| 0381 | No. 1, dto | 32,40 |
| 0382 | No. 2, dto. | 33,70 |
| 0383 | No. 3, dto. | 30,84 |
| 0384 | No. 4, dto. | 30,84 |
| 130-4 | Skirt shave "Osborne" (6,35 mm) | 74,60 |
| 130-8 | Skirt shave, "Osborne" (12,7 mm) | 76,20 |
| 925 | Leatherskive "Osborne" | 11,20 |
| 925 | -D Spare blades for No. 925, 20 pcs. in spender | 14,20 |
| 925 | -100 Spare blades for No. 925, 100 pcs. | 39,80 |
| | Mini-shave | |
| 0295 | Simple adjustable blade | 8,90 |
| 0296 | Triple adjustable blade | 14,36 |
| 0297 | Spare blades for No's. 295 & 296, 5 Pcs. | 3,84 |
| | Pull-shave (f.e.to file foam) | |
| 25.1.21.115 | Pull-shave with exchangeable blade (Blade 60 x 42 mm) | 4,90 |
| 25.1.21.515 | Spare blade for pull-shave | 3,10 |
| LF3101-00 | Mini anvil | 23,40 |

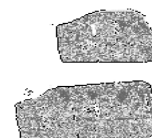

| Art. No. | Article name | Prices ex VAT. (€) |
|--|---|--------------------|
| 050 Markers, racers, grooving tools | | |
| | Suitcasescrach "BLANCHARD, Paris" | |
| 0401 | No. 1 | 42,88 |
| 0402 | No. 2 | 42,88 |
| 0403 | No. 3 | 42,88 |
| 0404 | No. 4 | 42,88 |
| | Adjustable gouge "Osborne" | |
| 128 | .1 u-form (3/32") 2,4 mm | 27,60 |
| 128 | .2 u-form (1/8") 3,2 mm | 27,60 |
| 128 | .3 u-form (5/32") 4,0 mm | 27,60 |
| 128 | .90° -angle | 27,60 |
| 34 | Scratch compass "Osborne" Including 3 different scratchers and 1 point. | 115,60 |
| 0430 | Double point compass racer (brass) "BLANCHARD" | 148,64 |
| LF807400 | Stiching groover , small | 12,15 |
| LF807500 | Spare blade for stitching groover | 6,30 |
| LF806900 | Stiching groover , big | 16,00 |
| LF807000 | Spare blade for stitching groover | 5,50 |

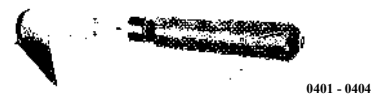











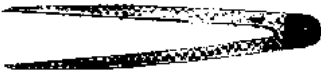
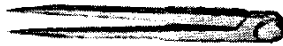

0401 - 0404











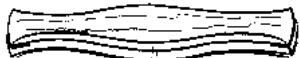

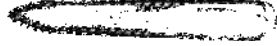

34





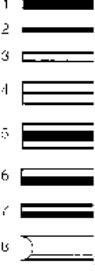































































































0430

| Art. No. | Article name | Prices ex VAT. (€) | |
|-------------------------------------|--|--------------------|---|
| 060 Rulers and compass tools | | | |
| | Screw compass/ Wing divider "BLANCHARD, Paris" | | |
| 0446 | No. 6 160 mm | 60,34 |  |
| 0447 | No. 7 195 mm | 58,02 | |
| 0448 | No. 8 215 mm | 62,02 | |
| | Simple compass/divider "BLANCHARD, Paris" | | |
| 0456 | No. 6 170 mm | 50,20 |  |
| 0457 | No. 7 195 mm | 46,42 | |
| 0458 | No. 8 215 mm | 48,70 | |
| 0461.150 | Compass, slender form, 150 mm | 12,96 |  |
| 0461.175 | Compass, slender form, 175 mm | 14,60 | |
| 0462 | Screw compass, slender form, 150 mm | 15,86 |  |
| 0463.150 | Spring compass, slender form, 150 mm | 9,85 |  |
| 0463.175 | Spring compass, slender form, 175 mm | 11,76 | |
| 0463.200 | Spring compass, slender form, 200 mm out of order | 13,26 | |
| 0465.150 | Screw compass, with pencil adjustment, 150 mm | 21,80 |  |
| 0462.300 | Screw compass, with pencil adjustment, 300 mm | 35,90 | |
| 0471 | Tape ruler 150 cm, scale inch & metric | 3,10 |  |
| 0471.10 | 10 Pcs. | 9,71 | |
| 0475 | Steel square, 1000 x 500 mm | 29,70 |  |
| 0472.600 | Aluminum ruler, 600 mm, with scale | 13,90 |  |
| 0472.1000 | Aluminum ruler, 1000 mm, with scale | 21,60 | |
| 0477 | Trapezoid-ruler without scale, 2000 x 100 x 17 mm | 19,00 |  |
| 0478S | Silverpen "Schneider- Mine 75", 1 Pc | 1,50 |  |
| 0478 | Silverpen, no name ,10 Pcs. To scetch and draw on dark leather | 12,00 | |
| 190102 | Thickness-ruler "Käfer K15" From 0 - 10 mm measurments, scale 0,10 mm | 72,32 |  |
| 0470 | Brass sliding caliper 100 mm scale-length, scale for inch & metric | 7,96 |  |
| 0499 | Lyra-signing crayon .H Haft for signing crayon | 8,35 |  |
| | .1 signing crayon „Lyra“, white | 0,71 | |
| | .9 signing crayon „Lyra“, blue | 0,70 | |
| | .11 signing crayon „Lyra“, yellow | 0,70 | |
| 88 | Cushion crayon Box with mixed colours, 12 Pcs | 16,40 |  |
| 88.1 | 1 Pcs. | 2,05 | |

| Art. No. | Article name | Prices ex VAT. (€) | |
|---|---|--------------------|---|
| 070 Decoration tools and loop wedges | | | |
| 20-C | Wood creaser, small „Osborne“ | 11,60 |  |
| 0480 | Boxwood creaser „Blanchard“ | 14,36 |  |
| 0480.GGS | Boxwood creaser , big Model | 19,36 | |
| 0482 | Wood creaser, bone plated (animal bone) | 26,58 | |
| 0482 | Wood creaser, bone plated (animal bone) | 26,58 |  |
| 0483 | Spare bone plate for No. 482 | 5,12 |  |
| | Metal creaser "Osborne" | | |
| 21 | -1 No. 1 | 27,00 |  |
| 21 | -2 No. 2 | 27,00 | |
| 21 | -3 No. 3 | 27,00 | |
| 21 | -4 No. 4 | 27,00 | |
| 21 | -5 No. 5 | 27,00 | |
| 0490 | Wood folder, "BLANCHARD, Paris" (hard wood) | 28,74 | |
| 190019 | Bone folder, "Banana", 200 mm (animal bone) | 6,91 |  |
| 190020 | Bone folder 180/23 mm, bent (animal bone) | 5,18 | |
| 190021 | Bone folder 160/20 mm, straight (animal bone) | 3,40 | |
| 0501 | Cornette french creaser, single | 25,09 |  |
| 0502 | Cornette french creaser, double adjustable | 50,66 |  |
| 459 | Embossing wheel carriage, "Osborne" | 41,00 |  |
| | .6 to .19 different embossing wheels each | 12,60 |  |
| | Purse crease "BLANCHARD, Paris" | | |
| 0511 | single No. 1 broad | 22,86 |  |
| 0512 | single No. 2 slim | 23,56 | |
| 0523 | double No. 3 | 29,92 | |
| 0526 | double NO. 6 | 28,50 | |
| 0527 | double No. 7 | 26,20 | |
| 0534 | triple No. 4 | 33,16 | |
| 0535 | triple No. 5 | 30,48 | |
| 0538 | Hollow ground No. 8 | 30,48 | |
| | | |  |
| 0540 | Loop wedges set, 8 Pcs. Widths: 13, 16, 18, 20, 23, 25, 27, 30 mm Single delivery on demand | 74,50 |  |
| 0540.10 | Loop wedge, 10 mm Other sizes on demand | 10,14 | |
| 0460 | Bombier-wood /grooved wood to ball out leather (f.e.Noseband Hanovarian.Halter.) | 42,00 | |

Art. No. Article name Prices ex VAT. (€)

070 Decoration tools and loop wedges (cont.)





















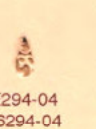





















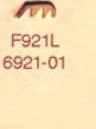
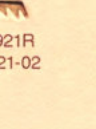

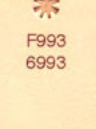
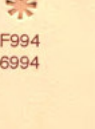



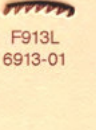
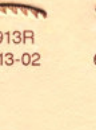
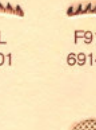







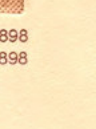



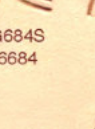
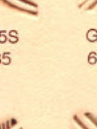



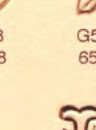



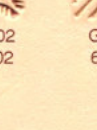





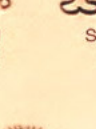
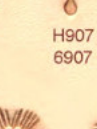

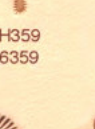
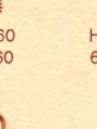

| | | | | | | | | | |
|---|---|---|---|---|--|---|---|---|---|
|  |  |  |  |  |  |  |  |  |  |
| Background | A104-2 66104-22 | A104 6104 | A105 6105 | A114 6114 | A888-2 66888-22 | A888 6888 | A889 6889 | A118 6118 | A101 6101 |
|  |  |  |  |  |  |  |  |  |  |
| A100 6100 | A103 6103 | A102 6102 | A800 6800 | A98 6098 | A117 6117 | A99 6099 | A106 6106 | Beveler | B935 6935 |
|  |  |  |  |  |  |  |  |  |  |
| B203 6203 | B200 6200 | B197 6197 | B201 6201 | B997 6997 | B936 6936 | B701 6701 | B198 6198 | B702 6702 | B205 6205 |
|  |  |  |  |  |  |  |  |  |  |
| B971 66971 | B836 6836 | B801 6801 | B802 6802 | B803 6803 | B204 6204 | B199 6199 | B893 6893 | B202L 6202-01 | B202R 6202-02 |
|  |  |  |  |  |  |  |  |  |  |
| B961 6961 | B892 6892 | B60 6060 | B243 6243 | B264 6264 | B242 6242 | B263 6263 | B262 6262 | B244 6244 | Barbed Wire |
|  |  |  |  |  |  |  |  |  |  |
| BW1 69001 | BW2 69002 | BW3 69003 | BW4 69004 | BW1-2 69001-50 | BW2-2 69002-50 | BW3-2 69003-50 | BW4-2 69004-50 | BW449 6449 | BW448 6448 |
|  |  |  |  |  |  |  |  |  |  |
| Camouflage | C770 6770 | C828 6828 | C428 6428 | C425 6425 | C709 6709 | C431 6431 | C940 6940 | C834 6834 | C366 6366 |
|  |  |  |  |  |  |  |  |  | |
| C432 66432 | C830 6830 | C433 6433 | C831 6831 | C426 6426 | C453 6453 | C454 6454 | C455 6455 | | |
|  |  |  |  |  |  |  |  |  |  |
| Border | D443 6443 | D444 6444 | D445 6445 | D447 6447 | D435 6435 | D436 66436 | D438 6438 | D439 6439 | D434 6434 |
|  |  |  |  |  |  |  |  |  | |
| D637 66637 | D607 66607 | D606 6606 | D616 6616 | D616-1/2 67010-01 | D617 6617 | Special | E385 66385 | E483 66483 | |

Art. No.

Article name

Prices ex VAT. (€)

070 Decoration tools and loop wedges (cont.)

| | | | | | | | | | |
|---|--|---|--|--|---|--|--|--|---|
|  E568 66568 |  E571 66571 |  E572 66572 |  E574 66574 |  E471L 66471-01 |  E471R 66471-02 |  E682 66682 |  E318 66318 |  E671 66671 | |
|  E580 66580 |  E672 66672 |  E294 Series |  E294-04 66294-04 |  E294-01 66294-01 |  E294 66294 |  E294-03 66294-03 |  Leaves & Flowers |  F990 6990 | |
|  F991 6991 |  F872 6872 |  F871 6871 |  F915 6915 |  F926 6926 |  F926D 66926-02 |  F926H 66926-03 |  F925 6925 |  F934 6934 |  F928 6928 |
|  F917 6917 |  F933 6933 |  F119 6119 |  F120 6120 |  F121 6121 |  F916 6916 |  F918 6918 |  F873 6873 |  F874 6874 |  F922 6922 |
|  F923 6923 |  F921L 6921-01 |  F921R 6921-02 |  F902 6902 |  F927 6927 |  F924 6924 |  F993 6993 |  F994 6994 |  F989 6989 |  F912L 6912-01 |
|  F912R 6912-02 |  F913L 6913-01 |  F913R 6913-02 |  F914L 6914-01 |  F914R 6914-02 |  F890 6890 |  F891 6891 |  F895 6895 |  F896 6896 |  F976 6976 |
|  F910 6910 |  F941 6941 |  F898 6898 |  F899 6899 |  F900 6900 |  F901 6901 |  Geometric |  G684S 6684 |  G685S 6685 |  G536 6536 |
|  G548 6548 |  G605 6605 |  G603 6603 |  G878 66878 |  G564 6564 |  G538 6538 |  G526 6526 |  G527 6527 |  G602 6602 |  G870 6870 |
|  G508 6508 |  G529 6529 |  G614 6614 |  G611 6611 |  Stops |  H907 6907 |  H908 6908 |  H359 6359 |  H360 6360 |  H903 6903 |
|  H904 6904 |  Flower Centers |  J815 6815 |  J615 6615 |  J820 6820 |  J816 6816 |  J547 6547 |  J786 6786 |  J520 6520 | |

Art. No.

Article name

Prices ex VAT. (€)

070 Decoration tools and loop wedges (cont.)

| | | | | | | | | | |
|---|---|---|---|---|---|--|---|---|---|
|  |  |  |  |  |  |  |  | | |
| Special | K133 68133 | K134 68134 | K146 68146 | K151L 68151-01 | K151R 68151-02 | K153L 68153-01 | K153R 68153-02 | | |
|  |  |  |  |  |  |  |  | | |
| K161 68161 | Leaf | L515 6515 | L516 6516 | L930 6930 | L929 6929 | L950 6950 | L951 6951 | | |
|  |  |  |  |  |  |  |  | | |
| L948 6948 | L949 6949 | L953 6953 | L954 6954 | L792 6792 | Matting tools | M880 6880 | M885 6885 | | |
|  |  |  |  |  |  |  |  |  | |
| M655 66655 | M656 66656 | M657 66657 | M881 6881 | M882 6882 | M884 6884 | Sunbursts | N309 6309 | N720 6720 | N300 6300 |
|  |  |  |  |  |  |  |  |  |  |
| N363 6363 | Special | O54 68054 | O53 68053 | 701003 67010-03 | 701009 67010-09 | O85 68085 | O86 68086 | O87 68087 | O89 68089 |
|  |  |  |  |  |  |  |  |  |  |
| Pear Shaders | P233 6233 | P972 6972 | P703 6703 | P206 6206 | P208 6208 | P367 6367 | P234 6234 | P973 6973 | P215 6215 |
|  |  |  |  |  |  |  |  |  |  |
| P207 6207 | P209 6209 | P368 6368 | P236 6236 | P975 6975 | P217 6217 | P213 6213 | P212 6212 | P370 6370 | P216 6216 |
|  |  |  |  |  |  |  |  |  |  |
| P210 6210 | P222 6222 | Ropes | R875 6875 | R959 6959 | R956 6956 | Seeders | S931 6931 | S932 6932 | S631 6631 |
|  |  |  |  |  |  |  |  |  |  |
| S632 6632 | S633 6633 | S864 6864 | S705 6705 | S706 6706 | S722 6722 | S724 6724 | S348 6348 | S343 6343 | S349 6349 |
|  |  |  |  |  |  |  |  |  |  |
| S630 6630 | S624 6624 | S625 6625 | Mule Foot | U851 6851 | U853 6853 | U859 6859 | U710 6710 | U867 6867 | U855 6855 |

Art. No.

Article name

Prices ex VAT. (€)

070 Decoration tools and loop wedges (cont.)

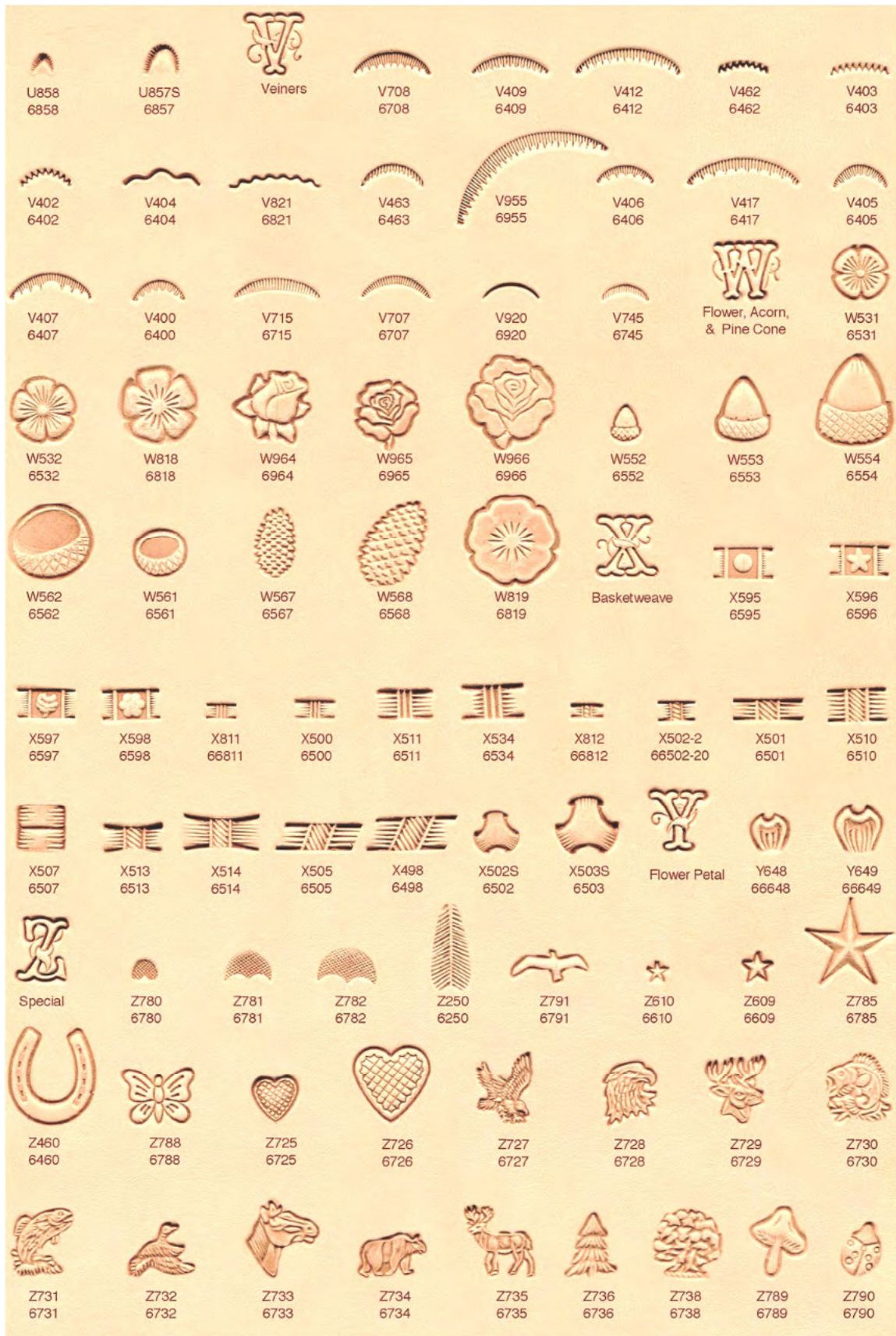

| Art. No. | Article name | Prices ex VAT. (€) |
|---|--|--------------------|
| 070 Decoration tools and loop wedges (cont.) | | |
| LF A104-2 to LF Z790 | Decoration stamps, illustration p. 14 to 17 | 10,00 |
| | Decoration stamps 3-D | 6,00 |
| LF 8197 | Hefty Handle | 11,90 |
| LF 8200-01 | Springloaded stamp handle | 9,20 |
| 2101.Set8 | Basic carving set: 6 ordinary stamps, swivel knife and screw driver | 42,67 |
| 2200.7 | Alphabet & Numbers, 7 mm | 34,30 |
| 2214 | Alphabet, 12,5 mm | 40,25 |
| 2215 | Numbers, 12,5 mm | 26,60 |
| 2216 | Alphabet „Western“, 19mm | 41,70 |
| 2217 | Alphabet „Western“, 19mm, decorate | 33,74 |
| 2218 | Alphabet „Western“, 25mm | 49,00 |
| | Industrial stamps, Numbers: 0 - 9 | |
| 2206 | 4 mm | 17,50 |
| 2206 | 6 mm | 14,70 |
| 2208 | 8 mm | 20,20 |
| 2210 | 10 mm | 27,55 |
| | Industrial stamps, Letters: A - Z | |
| 2224 | 4 mm | 32,60 |
| 2226 | 6 mm | 51,60 |
| 2228 | 8 mm | 60,40 |
| 2230 | 10 mm | 72,30 |



These and other animal patterns are for single order as well.

| | | |
|------------|---|-------|
| 444 | Swivel-knife "Osborne" incl. 1 blade | 27,20 |
| 446 | incl. 3 different blades | 85,60 |



| Art. No. | Article name | Prices ex VAT. (€) |
|---|--------------|--------------------|
| 071 Company stamps, saddle markings etc. | | |

Pictures are small scale!

| | |
|-------------|--|
| 2100 | Custom made company stamps to Mark Your product to Your design! |
|-------------|--|

Prices differ with order!!!



Customized Saddle escutcheons on demand

Signs

| | | |
|-----------------|---|-------|
| OE EL 25 | Gummed signs „Echtes Leder“ 20 x 22 Price per 1.000 | 22,90 |
| OE EL 66 | Hanging signs „Echtes Leder“ 28 x 32 Price per 1.000 | 54,90 |

Smaller orders possible!!!

Art. No. Article name Prices ex VAT. (€)

080 Strap end chisels

Pointed chisels "BLANCHARD, Paris"

| | | |
|-------------|---------------------|--------|
| 0553 | No. 3, 8 mm width | 51,18 |
| 0554 | No. 4, 11 mm width | 48,48 |
| 0555 | No. 5, 13 mm width | 54,54 |
| 0556 | No. 6, 15 mm width | 67,28 |
| 0557 | No. 7, 17 mm width | 74,82 |
| 0558 | No. 8, 19 mm width | 84,66 |
| 0559 | No. 9, 21 mm width | 91,36 |
| 0560 | No. 10, 23 mm width | 92,78 |
| 0561 | No. 11, 26 mm width | 114,50 |
| 0562 | No. 12, 28 mm width | 117,94 |
| 0563 | No. 13, 31 mm width | 131,04 |
| 0564 | No. 14, 33 mm width | 135,88 |
| 0565 | No. 15, 35 mm width | 143,14 |
| 0566 | No. 16, 37 mm width | 150,86 |
| 0567 | No. 17, 39 mm width | 163,62 |
| 0568 | No. 18, 41 mm width | 188,38 |

Oval chisels "BLANCHARD, Paris"

| | | |
|-------------|---------------------|--------|
| 0583 | No. 3, 8 mm width | 39,46 |
| 0584 | No. 4, 11 mm width | 42,68 |
| 0585 | No. 5, 13 mm width | 37,38 |
| 0586 | No. 6, 15 mm width | 43,04 |
| 0587 | No. 7, 17 mm width | 53,46 |
| 0588 | No. 8, 19 mm width | 63,16 |
| 0589 | No. 9, 21 mm width | 69,50 |
| 0590 | No. 10, 23 mm width | 78,28 |
| 0591 | No. 11, 26 mm width | 90,16 |
| 0592 | No. 12, 28 mm width | 102,36 |
| 0593 | No. 13, 31 mm width | 111,44 |
| 0594 | No. 14, 33 mm width | 116,98 |
| 0595 | No. 15, 35 mm width | 129,74 |
| 0596 | No. 16, 38 mm width | 137,22 |
| 0597 | No. 17, 39 mm width | 146,32 |
| 0598 | No. 18, 41 mm width | 151,00 |

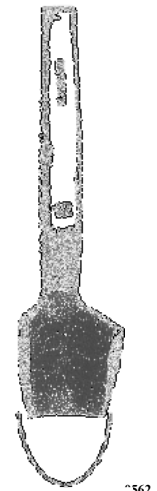

Art. No. Article name Prices ex VAT. (€)

090 Hole punches

Crew /trace end punches "BLANCHARD, Paris"

| | | | |
|------|--------|-------------|--------|
| 0603 | No. 3 | 7 x 2 mm | 38,98 |
| 0604 | No. 4 | 9 x 2,5 mm | 42,50 |
| 0605 | No. 5 | 11 x 2,5 mm | 49,22 |
| 0606 | No. 6 | 13,5 x 3 mm | 60,52 |
| 0607 | No. 7 | 16 x 3 mm | 69,28 |
| 0608 | No. 8 | 18 x 4 mm | 84,36 |
| 0609 | No. 9 | 21 x 4 mm | 93,90 |
| 0610 | No. 10 | 23 x 4 mm | 95,18 |
| 0611 | No. 11 | 25 x 4 mm | 111,24 |
| 0612 | No. 12 | 27 x 4 mm | 127,44 |
| 0613 | No. 13 | 30 x 4,5 mm | 129,56 |
| 0614 | No. 14 | 32 x 5 mm | 140,12 |
| 0615 | No. 15 | 34 x 5 mm | 131,94 |
| 0616 | No. 16 | 36 x 5 mm | 159,80 |
| 0617 | No. 17 | 36 x 6 mm | 147,44 |
| 0618 | No. 18 | 42 x 6 mm | 155,10 |



Crew /trace end punches "Dixon".

| | | | |
|------|--------|-------------|-------|
| 0633 | No. 33 | 9 x 2 mm | 48,77 |
| 0634 | No. 34 | 10 x 2 mm | 50,19 |
| 0635 | No. 35 | 13 x 2,5 mm | 56,18 |
| 0636 | No. 36 | 16 x 3 mm | 61,58 |
| 0637 | No. 37 | 18 x 4 mm | 68,88 |
| 0638 | No. 38 | 22 x 4 mm | 75,97 |
| 0639 | No. 39 | 26 x 5 mm | 82,27 |
| 0640 | No. 40 | 31 x 6 mm | 89,62 |

Crew / trace end punches (Henkelocheisen)

| | | | |
|--------|--|-------------|-------|
| 190650 | | 8x 4 mm | 15,19 |
| 190650 | | 10 x 4 mm | 27,60 |
| 190650 | | 11 x 2,5 mm | 30,36 |
| 190650 | | 12 x 3 mm | 24,12 |
| 190650 | | 13 x 3 mm | 30,36 |
| 190650 | | 14 x 3 mm | 26,80 |
| 190650 | | 15 x 4 mm | 26,80 |
| 190650 | | 16 x 4 mm | 31,74 |
| 190650 | | 17 x 4 mm | 33,12 |
| 190650 | | 18 x 4 mm | 28,98 |
| 190650 | | 20 x 3 mm | 30,82 |
| 190650 | | 20 x 4 mm | 31,74 |
| 190650 | | 20 x 5 mm | 33,12 |
| 190650 | | 21 x 4 mm | 42,78 |
| 190650 | | 22 x 4 mm | 35,88 |
| 190650 | | 22 x 5 mm | 45,54 |
| 190650 | | 24 x 5 mm | 48,30 |
| 190650 | | 25 x 4 mm | 38,64 |
| 190650 | | 26 x 5 mm | 51,06 |
| 190650 | | 28 x 4 mm | 41,40 |
| 190650 | | 30 x 5 mm | 60,72 |
| 190650 | | 31 x 5 mm | 52,44 |
| 190650 | | 32 x 4 mm | 62,10 |
| 190650 | | 34 x 4 mm | 53,75 |
| 190650 | | 35 x 6 mm | 67,62 |
| 190650 | | 36 x 5 mm | 70,38 |
| 190650 | | 40 x 5 mm | 62,10 |

**Custom punches by Henkelocheisen to Your needs for choice list prices.
Prices on demand!**

| Art. No. | Article name | Prices ex VAT. (€) |
|---------------------------------|---|--------------------|
| 090 Hole punches (cont.) | | |
| | Round punches "Dixon" | |
| 0680 | .0 1,0 mm | 30,18 |
| 0680 | .1 1,5 mm | 27,74 |
| 0680 | .2 2,0mm | 27,62 |
| 0680 | .3 2,5 mm | 27,64 |
| 0680 | .4 3,0 mm | 27,62 |
| 0680 | .5 3,5 mm | 27,62 |
| 0680 | .6 4,0 mm | 27,62 |
| 0680 | .7 5,0 mm | 28,62 |
| 0680 | .8 6,0 mm | 28,62 |
| 0680 | .9 7,0 mm | 28,62 |
| 0680 | .10 8,0 mm | 31,44 |
| 0680 | .11 9,0 mm | 35,72 |
| 0680 | .12 10,0 mm | 35,72 |
| 0680 | .13 11,5 mm | 44,38 |
| 0680 | .14 12,5 mm | 49,51 |
| 0680 | .15 15,0 mm | 52,10 |
| 0680 | .16 16,0 mm | 62,32 |
| 0699.T | Hole punch set, (9 Pcs.), 2 - 10 mm, in a bag | 19,12 |
| 0699.Set 9HAST | Hole punch set in Wood stand, (9 Pcs.), Made in Germany from 2 – 10 mm | 22,63 |
| 0699 | round punch set complete (25 Pcs.) from 1 - 25 mm | 125,92 |
| | Round punch,slim shaft | |
| 0699. | 01 mm | 2,35 |
| 0699. | 015 mm | 2,35 |
| 0699. | 02 mm | 2,35 |
| 0699. | 03 mm | 2,35 |
| 0699. | 04 mm | 2,35 |
| 0699. | 05 mm | 2,35 |
| 0699. | 06 mm | 2,35 |
| 0699. | 07 mm | 2,69 |
| 0699. | 08 mm | 3,00 |
| 0699. | 09 mm | 3,36 |
| 0699. | 10 mm | 3,66 |
| 0699. | 11 mm | 4,47 |
| 0699. | 12 mm | 5,16 |
| 0699. | 13 mm | 5,73 |
| 0699. | 14 mm | 6,45 |
| 0699. | 15 mm | 7,14 |
| 0699. | 16 mm | 8,07 |
| 0699. | 17 mm | 9,32 |
| 0699. | 18 mm | 10,27 |
| 0699. | 19 mm | 11,26 |
| 0699. | 20 mm | 12,79 |
| 0699. | 21 mm | 13,77 |
| 0699. | 22 mm | 14,91 |
| 0699. | 23 mm | 16,47 |
| 0699. | 24 mm | 17,58 |
| 0699. | 25 mm | 18,63 |
| | Round punch, "Henkelform" | |
| 190022. | 01 mm | 3,53 |
| 190022. | 02 mm | 3,63 |
| 190022. | 03 mm | 3,53 |
| 190022. | 04 mm | 3,53 |
| 190022. | 05 mm | 3,53 |
| 190022. | 06 mm | 3,53 |

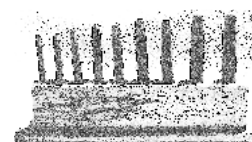

0699 Set 9 Holzkasten

| Art. No. | Article name | Prices ex VAT. (€) |
|---------------------------------|--------------|--------------------|
| 090 hole punches (cont.) | | |
| 190022. | 07 mm | 3,53 |
| 190022. | 08 mm | 3,53 |
| 190022. | 09 mm | 3,65 |
| 190022. | 10 mm | 4,28 |
| 190022. | 11 mm | 4,60 |
| 190022. | 12 mm | 4,95 |
| 190022. | 13 mm | 5,73 |
| 190022. | 14 mm | 5,93 |
| 190022. | 15 mm | 6,55 |
| 190022. | 16 mm | 7,18 |
| 190022. | 17 mm | 7,68 |
| 190022. | 18 mm | 8,25 |
| 190022. | 19 mm | 8,70 |
| 190022. | 20 mm | 10,30 |
| 190022. | 21 mm | 10,88 |
| 190022. | 22 mm | 11,20 |
| 190022. | 23 mm | 12,65 |
| 190022. | 24 mm | 13,70 |
| 190022. | 25 mm | 15,15 |
| 190022. | 26 mm | 15,70 |
| 190022. | 27 mm | 16,78 |
| 190022. | 28 mm | 18,08 |
| 190022. | 29 mm | 19,95 |
| 190022. | 30 mm | 21,15 |
| 190022. | 32 mm | 22,38 |
| 190022. | 34 mm | 24,75 |
| 190022. | 35 mm | 25,73 |
| 190022. | 36 mm | 26,96 |
| 190022. | 40 mm | 34,73 |
| 190022. | 45 mm | 44,58 |
| 190022. | 50 mm | 44,82 |
| 190022. | 52 mm | 51,20 |
| 190022. | 60 mm | 75,52 |
| 190022. | 62 mm | 82,44 |
| 190022. | 80 mm | 140,29 |

**Different sizes of Henkelform available
Round punches up to 120 mm on short notice.**

| Buttonhole punches | | |
|--------------------|--------------------------|-------|
| 0802.10 | hole 2 mm / chisel 10 mm | 39,94 |
| 0802.12 | hole 2 mm / chisel 12 mm | 39,94 |
| 0803.10 | hole 3 mm / chisel 10 mm | 39,94 |
| 0803.12 | hole 3 mm / chisel 12 mm | 39,94 |
| 0804.10 | hole 4 mm / chisel 10 mm | 39,94 |
| 0804.12 | hole 4 mm / chisel 12 mm | 39,94 |
| 0805.10 | hole 5 mm / chisel 10 mm | 48,50 |
| 0805.12 | hole 5 mm / chisel 12 mm | 48,50 |
| 0805.25 | hole 5 mm / chisel 25 mm | 89,60 |
| 0805.26 | hole 5 mm / chisel 26 mm | 89,60 |



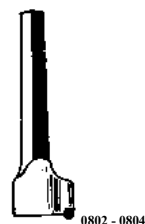

Special sizes on demand!





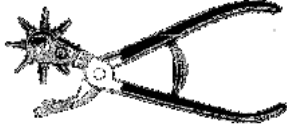

| | | |
|------|--|-------|
| 0901 | Sale „OL“, single pieces left!! oval punchl, p.P. | 15,34 |
|------|--|-------|

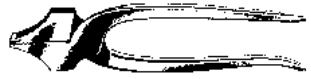

0802 - 0804

| Art. No. | Article name | Prices ex VAT. (€) |
|--|---------------------|---------------------------|
| 090 Hole punches (cont.) | | |
| Oval punches "Dixon" | | |
| 1021 | No. 17 2 x 1,5 mm | 37,02 |
| 1022 | No. 18 2,5 x 2 mm | 37,02 |
| 1023 | No. 19 3 x 2,5 mm | 37,02 |
| 1024 | No. 20 3,5 x 2,5 mm | 37,02 |
| 1025 | No. 21 4 x 3 mm | 37,02 |
| 1026 | No. 22 4,5 x 3,5 mm | 37,02 |
| 1027 | No. 23 6 x 4 mm | 38,74 |
| 1028 | No. 24 7,5 x 4 mm | 43,26 |
| 1029 | No. 25 8,5 x 5,5 mm | 44,89 |
| 1030 | No. 26 9,5 x 6 mm | 46,64 |
| 1031 | No. 27 12 x 7 mm | 48,73 |
| 1032 | No. 28 13 x 7 mm | 50,54 |
| 1033 | No. 29 14 x 8 mm | 56,92 |
| 1034 | No. 30 15 x 8 mm | 65,03 |
| 1035 | No. 31 16 x 11 mm | 75,10 |
| 1036 | No. 32 17 x 11,5 mm | 79,15 |
| Oval punches (in part „Henkellocheisen“) | | |
| 190652. | 4 x 2,5 mm | 15,53 |
| 190652. | 4 x 3 mm | 15,08 |
| 190652. | 5 x 3 mm | 15,53 |
| 190652. | 6 x 4 mm | 17,25 |
| 190652. | 7 x 5 mm | 17,25 |
| 190652. | 8 x 4 mm | 17,25 |
| 190652. | 9 x 6 mm | 18,98 |
| 190652. | 10 x 7 mm | 23,45 |
| 190652. | 12 x 8 mm | 25,15 |
| 190652. | 13 x 8 mm | 25,60 |
| 190652. | 13 x 12 mm | 34,56 |
| 190652. | 16 x 9 mm | 35,84 |
| 190652. | 18 x 12 mm | 39,68 |
| 190652. | 23 x 13 mm | 48,64 |
| 190652. | 26 x 17 mm | 57,60 |
| 190652. | 28 x 18 mm | 60,16 |
| 190652. | 30 x 20 mm | 68,34 |
| Other sizes on demand! | | |

| Art. No. | Article name | Prices ex VAT. (€) | |
|------------------------------|--|--------------------|---|
| 100 Hole punch pliers | | | |
| 190120 | Revolving punch pliers , Sheetsteel, massive | 12,18 |  190120 |
| 190121 | Lever punch pliers, <u>up to .70 % less force needed</u> | 25,73 | |
| 190122. | 1,5 -6,0 mm spare punch kit, 10 pcs. ,total | 10,94 | |
| 190122. | 2,0 -4,5 mm spare punch kit, 6 pcs. total | 6,14 | |
| 190122. | EWS spare punch kit , additional punches | 4,91 | |
| 190122 | 1,5 -5,0 mm single spare punch | 1,58 | |
| 190122. | 5,5 mm single spare punch | 2,21 | |
| 190122. | 6,0 mm single spare punch | 2,21 |  190121 |
| NEW | | | |
| 190121.OLFP | Hebel-Revolverlochzange mit Form- und Ovallochpfeifen Oval: 5,7x3,8 / 4,6x3,0 / 6,3x3,5 / 7,3x4,3 / 7,8x3 mm Formloch: 6,0 x 3 mm rechteckig | 29,96 |  190121.OLFP |
| 190122. | 4,6 oval spare punch, 4,6 x 3,0 mm | 3,68 | |
| 190122. | 6,0 oval spare punch, 6.0 x 4,0 mm | 3,68 | |
| 190124 | Punch changer | 4,40 | |
| 190126 | Revolving punch pliers, EC,large forged steel with screwed in punches | 59,46 | |
| 190126E | 1 spare punch for EC and EC 8 | 4,02 | |
| 190126E | 6 spare punches for EC | 24,12 | |
| 190126F | Spring for EC and EC 8 | 1,70 | |
| 190126A | Spare anvil for EC and EC 8 | 2,40 |  |
| 190136 | Revolving punch pliers, EC 8 like EC,but with eight instead of six punches | 65,56 | |
| 190126E | 8 spare punches für EC 8 | 32,16 |  190136 |
| 190128 | Lever hole punch pliers, forged steel, single punch Sizes 6 - 12 mm or pattern punches available (price whithout punch) | 44,40 | |
| 190128E6 | Spare punch, massive | 11,20 | |
| 190128E7 | Spare punch, massive | 15,08 | |
| 190128E8 | Spare punch, massive | 10,68 | |
| 190128E9 | Spare punch, massive | 15,08 | |
| 190128E10 | Spare punch, massive | 11,20 | |
| 190128E11 | Spare punch, massive | 15,08 | |
| 190128E12 | Spare punch, massive | 11,20 |  190128 |
| 1050 | Revolving punch pliers „Blanchard“ forged steel | 60,70 | |

| Art. No. | Article name | Prices ex VAT. (€) | |
|--|--|--------------------|---|
| 120 Leather – and upholstery pliers & pincers | | | |
| 250 | Canvas stretching plier "OSBORNE" | 59,40 |  |
| 1071 | Saddlers pincers "BLANCHARD, Paris" | 100,44 |  |
| 1082 | Saddlers pincers "J. Dixon" | 110,15 | |
| W829.01 | Fold - pincers, 24 mm | 48,70 | |
| 190160 | Lasting pliers, I a, MAUTHE Art. 820 10 mm width | 30,46 |  |
| 190161 | Lasting pliers, MAUTHE Art. 820 SM 10 mm width, with magnetized hammer | 39,96 | |
| 190171 | Lastig pliers, MAUTHE Art. 865 With straight, wide mouth. | 25,12 |  |
| 190172 | Lasting pliers, MAUTHE Art. 870 With bent, slim mouth. | 36,00 |  |
| 190173 | Lasting pliers MAUTHE Art. 875 With bent, wide mouth | 36,00 | |
| 190149 | Eyletremoving pincers | 38,80 |  |
| 190187 | Upholstery-cramp pliers, 180 mm | 40,00 |  |
| 3989 | Cramps for No. 190187, 25 mm, 2500 Pcs. | 22,80 | |
| 773K | Camps for No. 190187 pre bent 20 mm 1000 Pcs. | 18,60 | |
| | 20 mm 100 Pcs. | 3,26 | |
| | 25 mm 1000 Pcs. | 23,00 | |
| | 25 mm 100 Pcs. | 4,03 | |

Additional special pliers & pincers see MAUTHE/OSBORNE supplements!

| Art. No. | Article name | Prices ex VAT. (€) |
|---|--|--------------------|
| 130 General pliers & pincers | | |
| 190135 | Cutting nipper | 29,80 |
| | Lever –supported cuttin nipper | |
| 1092.180 | 180 mm | 55,90 |
| 1092.200 | 200 mm = 8" | 57,00 |
| 1092.215 | 215 mm = 8,5" | 38,40 |
| 1092.230 | 230 mm = 9" | 48,40 |
| | Blades tempered via inductivity f.e. to cu iron rivets! | |
| 1093 | Rabit pliers, 250 mm | 2,71 |
| | Flat –nose pliers | |
| 190186 | 160 mm | 13,95 |
| 190185 | 200 mm Knipex | 16,67 |
| 190129 | Knipex diagonal cutting nippers for plastic, 160 mm | 27,61 |
| | Diagonal cutting nippers (top blade only) | |
| 190130. | .140 mm | 17,18 |
| | .160 mm | 21,60 |
| 190131 | Diagonal cutting nippers, 160 mm | 16,20 |
| 190132.140 | Diagonal cutting nippers, 140 mm | 20,15 |
| 190134 | Cutting nippers "Vienna" | 32,72 |
| 190150 | Shoemaker`s pincers | 17,34 |
| 190152 | Manchester pincers | 51,10 |
| | Combination pliers „Knipex“ | |
| 190180 | 160 mm | 9,97 |
| 190182 | 180 mm | 10,53 |
| | Power diagonal cutting nippers 64 HRC | |
| 190133 | .160 mm | 23,20 |
| | .180 mm | 25,60 |
| W8603.0 | Riveting pincers “Knipex“ (for fittings) | 68,90 |

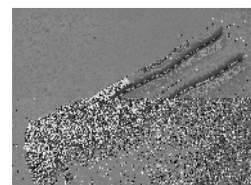

W8603.0

| Art. No. | Article name | Prices ex VAT. (€) |
|---------------------|--|--------------------|
| 140 | Scissors | |
| 1102 | Trimming scissors, 20 cm Lower blade microtoothed for leather . And heavy fabric | 27,44 |
| 1102L | Trimming scissors, 20 cm for lefthanded people | 26,52 |
| 1104 | Combi-Scissors „Allesschneider“ Cuts cardboard, paper, leather, thin sheet metal etc. | 12,02 |
| | Dressmaking scissors MAUTHE | |
| 190220 | 8", 200 mm | 28,88 |
| 190221 | 9", 230 mm | 36,00 |
| 190222 | 10", 250 mm | 38,40 |
| 190222-2B | Dressmaking scissors 10", 250 mm | 14,79 |
| 190223 | 12", 300 mm | 52,50 |
| 190224 | 8", 200 mm, for lefthanded people | 39,22 |
| 190226 | 10", 250 mm, for lefthanded people | 104,80 |
| 190220 | Dressmaking scissors "Finny", 280 mm | 28,50 |
| 190295.7 | Heavy scissors MAUTHE, 180 mm | 23,86 |
| 11.6.72025 | Dressmaking scissors "Finny", 250 mm | 28,00 |
| 190261 | Single loop scissors MAUTHE, straight | 19,30 |
| 190262 | Single loop scissors MAUTHE, bent | 22,70 |
| 190260 | Single loop scissors MAUTHE with elongated point | 17,79 |
| 190290 | Leather scissors MAUTHE, toothed, 220 mm | 27,23 |
| 190291 | Leather scissors MAUTHE, bent & toothed | 39,42 |
| 190293 | Heavy dutyscissors 8" , " Flossenschere" | 33,94 |
| 190292KC | Leather scissors (615) | 34,45 |
| 190280 | Zickzack-scissors MAUTHE, 8,5" | 32,45 |
| B837-060 | Scissors with plastic handle, 6" | 12,22 |
| K72407-1/2K | Scissors 16,5 cm, klein | 8,78 |
| K72407-1/2GR | Scissors 22,5 cm, groß | 13,12 |



1102

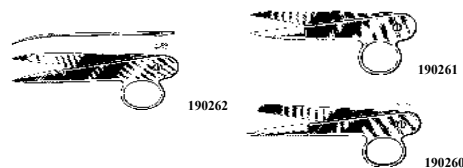

190262

190261

190260

| Art. No. | Article name | Prices ex VAT. (€) |
|---------------------------------|---|---------------------------|
| 150 Useful general tools | | |
| | Spiral drills HSS DIN 448 | |
| W43.020 | 2,0 mm 10 Pcs . | 2,45 |
| W43.025 | 2,5 mm 10 Pcs. | 2,81 |
| W43.030 | 3,0 mm je 10 Pcs. | 2,97 |
| W43.040 | 4,0 mm je 10 Pcs. | 3,58 |
| W43.045 | 4,5 mm je 10 Pcs. | 4,35 |
| W43.055 | 5,5 mm je 10 Pcs. | 5,11 |
| 151 Electric tools | | |
| DRG4001973018500 | Battery-stapler, „Takkurat FB14S“ 12 V spare battery in case | 178,50 |

| Art. No. | Article name | Prices ex VAT. (€) |
|-----------------|---|--------------------|
| 155 | Saddle and upholstery tools | |
| | Stuffing- pulling pliers | |
| 190178 | straight | 13,50 |
| 190179 | bent | 13,50 |
| 1134.40 | Stuffing-remover hook | 36,00 |
| 1135 | Stuffing-rod (8 mm stainless steel flat) | |
| | .15 cm length | 27,50 |
| | .20 cm length | 27,50 |
| | .25 cm length | 28,00 |
| | .30 cm length | 30,00 |
| | .35 cm length | 33,00 |
| | .40 cm length | 36,00 |
| | .45 cm length | 39,00 |
| | .50 cm length | 43,00 |
| | .55 cm length | 45,00 |
| | .60 cm length | 48,00 |
| | .70 cm length | 50,00 |
| 1135 | Stuffing- rod (6 mm stainless steel round) | |
| | .15 R cm length | 23,40 |
| | .20 R cm length | 23,40 |
| | .25 R cm length | 25,00 |
| | .30 R cm length | 29,95 |
| | .35 R cm length | 29,95 |
| | .40 R cm length | 35,00 |
| | .45 R cm length | 37,00 |
| | .50 R cm length | 40,00 |
| | .55 R cm length | 42,00 |
| | .60 R cm length | 45,00 |
| | .70 R cm length | 48,00 |
| | Different sizes on demand! | |
| 117 | Stuffing- rod "Osborne", 25 cm tempered steel | 44,20 |
| 1136. | Stuffing- rod "Dixon", tempered steel | |
| | 14" 35,56 cm length | 75,60 |
| | 16" 40,64 cm length | 79,91 |
| | 18" 45,75 cm length | 82,22 |
| 1140 | Hardwood smasher (for perfect stuffing of saddle cushions) | 30,70 |
| 1141 | Hardwood smasher small (especially for small hands) | 30,10 |
| 1142 | Hardwood smasher mini (for punktual stuffing) | 30,10 |
| 1143 | Smasher, lignum vitae | 123,00 |
| 1143.1/2 | Smasher, lignum vitae | 123,00 |
| 1150 | Strap-pulling thongs (To pull front straps easily through the cushion) | 39,00 |

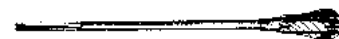

1135

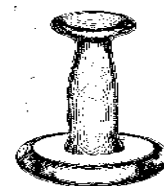

1140

Different stuffings on page 83!

| Art. No. | Article name | Prices ex VAT. (€) |
|----------------------------------|---|--------------------|
| 160 Hammers & mallets | | |
| 395-1 | Rawhide mallet „Osborne“ Nr. 1, head d = 32 mm | 98,80 |
| 395-2 | Nr. 2, head d = 38 mm | 106,80 |
| 395-3 | Nr. 3, head d = 45 mm | 136,80 |
| 1123 | Soft mallet SIMPLEX Nr. 30 (best used for embossing & carving) .4 with two superplastic heads | 24,20 |
| 1122 | .4 Spare head superplastic p.pce. | 5,10 |
| W226.40 | Soft mallet for hole punches etc. Soft mallet; 40 mm (recoil-free) With long hardwood handle | 37,90 |
| W226.50 | Soft mallet 50 mm (recoil-free) With long hardwood handle | 45,90 |
| W229.40 | Soft mallet; 40 mm (recoil-free) With short metal handle | 44,40 |
| W229.50 | soft mallet 50 mm (recoil-free) with short metal handle | 51,90 |
| 300 | Rawhide engravers mallet .950 950 g | 53,20 |
| | .1200 1200g | 56,53 |
| 300.950.E | Spare head for No. 300/ 950 g | 28,00 |
| 300.1250.E | Spare head for No. 300/ 1250 g | 30,00 |
| 1132 | Wooden mallet ,white beechwood d = 50 mm / Head 100 mm | 6,30 |
| 1148.70 | Wooden mallet, 70 x 140 | 8,30 |
| 1148.80 | Wooden mallet, 80 x 160 | 9,90 |
| 1149 | Wooden mallet, white beechwood, steelshod d = 70 mm / head 140 mm | 24,90 |
| 1139 | Rubber mallet d = 90 mm / head 140 mm | 14,20 |
| 1147.300 | German style cross pein hammer, 300 g | 3,50 |
| 1147 | German style cross pein hammer, 500 g | 13,20 |
| | Saddle/Harness hammer "BLANCHARD" | |
| 1151 | No. 1 150 g | 41,14 |
| 1152 | No. 2 220 g | 44,92 |
| 1153 | No. 3 245 g | 43,70 |
| 1154 | No. 4 285 g | 48,82 |
| 1155 | No. 5 375 g | 50,46 |
| 1156 | No. 6 470 g | 61,10 |
| 1152-53.H | Spare handle for No. 1151-1156 for No. 2 + 3 | 5,02 |
| 1154-56.H | for No. 4, 5, 6 | 5,00 |
| 1180 | Magnetic tack hammer "Picard" | 35,34 |
| 1182 | Clawpeined magnetic tack hammer "Picard" | 36,22 |
| 1183 | Magnetic tack hammer "Picard" | 43,94 |
| 1172 | Saddlers hammer „Dixon“ | 81,38 |

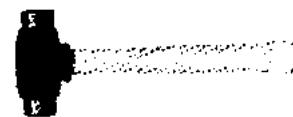

395

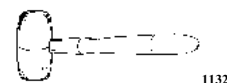

1132



1142



1151 - 1156

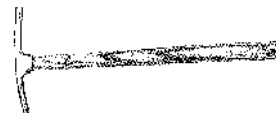

1180



1182

| Art. No. | Article name | Prices ev VAT. (€) |
|--|---|--------------------|
| 160 Hammers & mallets (cont.) | | |
| 55 | Saddlers hammer "Osborne" Nr. 55 Complete steel shanked with riveted walnut handle | 160,40 |
| 1174 | Tack hammer Nr. 14, Magnetic | 49,66 |
| 1175 | Nr. 14 "Picard" | 40,72 |
| 1174.1 | Spare handle with metal shoe for No. 1147 | 12,00 |
| 1178 | Upholsterers hammer, 14 mm | 9,97 |
| 190190 | Shoemaker`s hammer, 290 g | 17,58 |
| 190191 | Shoemaker`s hammer, 350 g | 18,82 |
| 190193 | Round wedges for Shoemaker`s hammer | 0,66 |
| 190194 | Spare handle for Shoemaker`s hammer | 2,74 |
| 190196 | Trace end hammer and seam.groover | 14,78 |
| 1204. | Hammer handles , Hickory 300 mm, up to 300 g weight 310 mm, up to 400 g weight | 1,94 2,10 |
| 1199. | Hammer wedges, "SFIX" | |
| | 13 mm 6 Pcs. | 0,97 |
| | 16 mm 6 Pcs. | 1,38 |
| | 20 mm 6 Pcs. | 1,79 |
| | 23 mm 6 Pcs. | 2,05 |
| | 13 - 23 mm 8 Pcs. | 2,02 |



| Art. No. | Article name | Prices ex VAT. (€) |
|---------------------------|--|--------------------|
| 170 Pricking tools | | |
| 1209 | Hand wheel pricker with magazine „Blanchard“ 4 Pricking wheels: 6, 8, 10 & 12 pricks per “ | 172,88 |
| 1210 | Hand wheel pricker & adjustable frame with magazine “Blanchard” 4 pricking wheels: 6, 8, 10 & 12 pricks per ” | 238,90 |
| 1220 | Pricking wheels for No`s. 1209 & 1210 from .4 to .20 pricks per “ each | 27,68 |
| 494 | D2 Pricking iron (for lacing) | 2mm 22,60 |
| 494 | D3 Pricking iron (for lacing) | 3mm 22,60 |
| | Pricking iron „Blanchard“ | |
| 3.702.0305 | No. 3/5 (.3 Prick) 5 pricks | 90,16 |
| 3.702.0306 | No. 3/6 (.3 Prick) 6 pricks (for Saddle straps) | 123,52 |
| 3.702.0402 | No. 4/2 (.4 Prick) 2 pricks | 36,06 |
| 3.702.0405 | No. 4/5 (.4 Prick) 5 pricks | 98,04 |
| 3.702.0406 | No. 4/6 (.4 Prick) 6 pricks | 108,18 |
| 3.702.0502 | No. 5/2 (.5 Prick) 2 pricks | 37,14 |
| 3.702.0505 | No. 5/5 (.5 Prick) 5 pricks | 90,16 |
| 3.702.0505L | No. 5/5 (.5 Prick) 5 pricks, left diagonal | 90,16 |
| 3.702.0602 | No. 6/2 (.6 Prick) 2 pricks | 39,22 |
| 3.702.0603 | No. 6/3 (.6 Prick) 3 pricks | 61,76 |
| 3.702.0603L | No. 6/3 (.6 Prick) 3 pricks, left diagonal | 54,10 |
| 3.702.0606 | No. 6/6 (.6 Prick) 6 pricks | 128,46 |
| 3.702.0606L | No. 6/6 (.6 Prick) 6 pricks, left diagonal | 117,66 |
| 3.702.0607 | No. 6/7 (.6 Prick) 7 pricks | 126,22 |
| 3.702.0702 | No. 7/2 (.7 Prick) 2 pricks | 39,22 |
| 3.702.0707 | No. 7/7 (.7 Prick) 7 pricks | 144,12 |
| 3.702.0708 | No. 7/8 (.7 Prick) 8 pricks | 156,86 |
| 3.702.0712 | No. 7/12 (.7 Prick) 12 pricks | 216,38 |
| 3.702.0802 | No. 8/2 (.6 Prick) 2 pricks | 41,18 |
| 3.702.0808 | No. 8/8 (.8 Prick) 8 pricks | 171,28 |
| 3.702.0810 | No. 8/10 (.8 Prick) 10 pricks | 205,90 |
| 3.702.0902 | No. 9/2 (.9 Prick) 2 pricks | 38,26 |
| 3.702.0910 | No. 9/10 (.9 Prick) 10 pricks | 196,10 |
| 3.702.0915 | No. 9/15 (.9r Prick) 15 pricks | 270,48 |
| 3.702.1007 | No.10/7 (.10 Prick) 7 pricks Different sizes on demand! | 144,1222 |



| Art. No. | Article name | | Prices ex VAT. (€) |
|---------------------|--------------------------------------|-----------------------------------|---------------------------------|
| 180 Awls | | | |
| | Awl blades, hand filed | | |
| 001300.40g | 40 mm | p.pce. | 4,68 |
| 001300.50g | 50 mm | p.pce | 4,71 |
| | Awl blades, eine, slender form | | |
| 001300. | 40 mm | p.pce | 2,43 |
| 001300.45 OL | 45 mm | p.pce historical, slim form blade | 2,50 (temporarily out of stock) |
| 001300. | 45 mm | p.pce | 2,58 |
| 001300. | 50 mm | p.pce | 2,70 |
| 001300. | 55 mm | p.pce | 2,88 |
| 001300. | 60 mm | p.pce | 2,94 |
| 001300. | 65 mm | p.pce | 2,61 |
| 001300. | 70 mm | p.pce | 2,73 |
| 001300. | 75 mm | p.pce | 3,06 |
| 001300. | 80 mm | p.pce | 3,23 |
| 001300. | 90 mm | p.pce | 3,33 |
| 001300. | 100 mm | p.pce | 3,51 |
| 001300. | 125 mm | p.pce | 4,60 |
| 001300. | 180 mm | p.pce | 5,62 |
| | Awl blades, extra strong(John James) | | |
| 1300. | 55JJ mm | p.pce | 3,00 |
| 1300. | 60JJ mm | p.pce | 3,50 |
| | Curved awl blade (German form) | | |
| 1313 | .60 mm | p.pce | 1,92 |
| 1313 | .65 mm | p.pce | 1,80 |
| 1313 | .70 mm | p.pce | 2,08 |
| 1313 | .75 mm | p.pce | 2,12 |
| 1313 | .80 mm | p.pce | 2,28 |
| 1313 | .85 mm | p.pce | 2,40 |
| 1313 | .90 mm | p.pce | 2,40 |
| 1313 | .100 mm | p.pce | 2,60 |
| | Curved awl blade,(English form) | | |
| 1340 | Nr. 400 102 mm | p.pce | 8,00 |
| 1340.W | 104 mm | p.pce | 3,00 |











1301-1310



1313

| Art. No. | Article name | Prices ex VAT. (€) |
|-------------------------|--|---|
| 180 Awls (cont.) | | |
| 1350 | Steirische Ahle (sharp bent awl blade) 100 mm p.pce | 5,20 |
| | |  |
| | Steirische Ahle (sharp bent awl blade) "Blanchard" | |
| 1356 | Nr. 6, 64 mm p.pce | 7,40 |
| 1357 | Nr. 7, 55 mm p.pce | 6,58 |
| 1358 | Nr. 8, 53 mm p.pce | 6,46 |
| 1362 | Nr. 12, 40 mm p.pce | 6,46 |
| | Steirische Ahle (sharp bent awl blade) "Finnish form" | |
| 1357 Fin | 55 mm p.pce | 3,02 |
| 1356 Fin | 65 mm p.pce | 3,24 |
| 1347 Fin | 75 mm p.pce | 3,56 |
| 1348 Fin | 80 mm p.pce | 3,72 |
| | Stabbing awl "BLANCHARD, Paris", strong | |
| 1506 | 60 mm p.pce | 1,96 |
| 1507 | 70 mm p.pce | 2,14 |
| 1508 | 80 mm p.pce | 2,62 |
| 1509 | 90 mm p.pce | 2,33 |
| 1510 | 100 mm p.pce | 2,40 |
| 1511 | 110 mm p.pce | 3,62 |
| 1512 | 120 mm p.pce | 3,52 |
| | Stabbing awl, "Hartflex", very strong and fine | |
| 1540.HF | 40 mm p.pce | 1,35 |
| 1550.HF | 50 mm p.pce | 1,47 |
| 1560.HF | 60 mm p.pce | 1,45 |
| 1570.HF | 70 mm p.pce | 1,47 |
| 1580.HF | 80 mm p.pce | 1,59 |
| | Stabbing awl, fine & slim form | |
| 1540 | 40 mm p.pce | 1,02 |
| 1550 | 50 mm p.pce | 1,11 |
| 1560 | 50 mm p.pce | 1,17 |
| 1565 | 65 mm p.pce | 1,17 |
| 1570 | 70 mm p.pce | 1,17 |
| 1580 | 80 mm p.pce | 1,52 |
| 1590 | 90 mm p.pce | 1,49 |
| 1593 | 100 mm p.pce | 1,29 |
| | Collar awl | |
| 8 | .15 cm p.pce | 15,00 |
| 8 | .18,5 cm p.pce | 15,00 |
| 8 | .20 cm p.pce | 17,04 |
| 8 | .26 cm p.pce | 19,37 |
| 8 | .30 cm p.pce | 22,71 |
| 8 | .40 cm p.pce | 27,07 |
| | Collar awl, Osborne | |
| 8 | 25,4 cm (sharp) p.pce | 53,00 |
| 8-B | 25,4 cm (blunt) p.pce | 52,00 |

1348-1362

| Art. No. | Article name | Prices ex VAT. (€) | |
|------------------|--|--------------------|---|
| 190 Hafts | | | |
| 144 | Haft "Osborne", round | 3,20 | |
| | Hafts "BLANCHARD, Paris", flat | | |
| 1601 | small, 85 mm | 6,74 |  |
| 1602 | medium 95 mm | 6,86 | |
| 1603 | large, 105 mm | 7,56 | |
| | Hafts "BLANCHARD, Paris", round | | |
| 1604 | Fitting =7mm thick., haft 25mm thick., 95 mm long | 5,40 |  |
| 1605 | Fitting =7mm thick., haft 27 mm thick., 95 mm long | 5,82 | |
| 1606 | Fitting=10mm thick., haft 29mm thick., 95 mm long | 6,24 | |
| 1610 | Haft "Cito" adjustable, flat | 5,26 | |
| 1615 | Haft "Cito" adjustable, round | 5,26 |  |
| 1620 | Two part, adjustable haft, round | 5,26 |  |
| 1621 | Adjustable haft, round | 12,42 | |
| 1624 | Adjustable striking haft, 110 mm | 8,33 |  |
| 1624L | Adjustable striking hafte, 110 mm (Leathecircled back) | 8,33 | |
| 1651 | Haft, "Pistole" No. 1 | 6,00 |  |
| 1653 | Haft, "Pistole" No. 3 | 6,00 | |
| 1655 | Haft, "Pistole" No. 5 | 6,50 | |
| 1655S | Haft, "Pistole" No. 5, boxwood with screw | 7,00 | |
| | Haft "Wasse-"Patent | | |
| 1708 | 80 mm | 2,18 |  |
| 1709 | 90 mm | 2,24 | |
| | Haft "Wasse-"Patent, round, special sale | | |
| 1715 | 95 mm | 1,79 |  |
| | Internals for haft "Wasse-"patent | | |
| 1752 | Set (5 Pcs.) 1,8 mm Bohrung | 2,58 | |
| 1753 | dto. 3 mm Bohrung | 2,58 | |
| 1754 | dto. 4 mm Bohrung | 2,58 | |
| | Woodcarving hafts, steel-rimmed | | |
| 1738 | | 1,77 | |
| 1738B | special sale | 1,43 | |
| 1738.110 | | 1,92 | |
| 1738.130 | | 2,32 | |
| 1738.140 | | 2,68 | |
| | Hafts | | |
| 1739 | . 80 mm | 1,76 | |
| 1739 | .100 mm | 1,92 | |
| 1740 | Harness awl haft "BLANCHARD, Paris" | 5,14 | |
| 1741 | Harness awl haft, 125 mm, red | 2,00 | |

| Art. No. | Article name | Prices ev VAT. (€) |
|---------------------|--|---------------------------|
| 200 Prickers | | |
| | Pricker blade „Blanchard“ | |
| 1830.060 | Pricker blade short, incl. handle | 6,62 |
| 1830.100 | pricker blade long, incl. handle | 8,50 |
| 1830.oH.060 | Pricker blade only, short | 5,80 |
| 1830.oH.100 | Pricker blade only, long | 6,44 |
| 1849 | Pricker with striking handle | 3,25 |
| 1850 | Pricker short 50 mm | 1,79 |
| 1850.BH | Pricker, pear shaped handle | 1,68 |
| 1851 | Pricker blade 60 x 4,5 mm blade length x width | 2,86 |
| 1853 | Drift punch pricker, 127 x 6,5 mm usable length & width | 8,28 |
| 1854 | Scratch awl, 90 x 4,5 mm blade | 1,33 |
| 190113 | Scratch awl, 70 x 3,0 mm blade | 2,43 |
| 190110 | Scratch awl, round, pear shaped plastic handle ca. 6 x 110 mm | 2,56 |
| 190112 | Drift punch awl, round, pearshaped handle ca. 6 x 100 mm, | 8,60 |
| | Scratch awl incl. handle | |
| 1500.80 | 80 mm | 3,45 |
| 1500.140 | 140 mm | 4,14 |
| 1500.170 | 170 mm | 4,60 |
| 190114 | Different sized prickers on demand, resellers ask for special offers!! | |

| Art. No. | Article name | Prices ex VAT. (€) |
|--|--|--------------------|
| 210 Staple- and stretching tools & removers | | |
| 1951 | Goathoof tack remover | 8,75 |
| 402 | Tack remover "OSBORNE" | 21,80 |
| 190115 | Staple remover | 5,23 |
| E63003000000 | Staple remover „ ESCO Rapid 3“ | 11,00 |
| 190118 | Tack- and nail remover, straight | 9,30 |
| 255 | Chair strap stretcher "OSBORNE" (old No. 1960) | 20,80 |
| 253 | Chair strap stretcher with lever"OSBORNE" (old No. 1961) | 43,00 |
| 1965 | Decoration pin holder "OSBORNE"(new No. 777) | 10,80 |
| 1999 | Stapler RAPID 31 | 78,00 |
| 1999.06 | Staples 73/6 mm, 5000 pcs. | 20,00 |
| 1999.08 | Staples 73/8 mm, 5000 pcs. | 20,40 |
| 1999.10 | Staples 73/10 mm 5000 pcs. | 24,60 |
| 1999.12 | Staples 73/12 mm, 5000 pcs . | 25,40 |
| 1999WA | Square anvil | 20,45 |
| 2000 | Stapler RAPID 1 | 30,06 |
| 2000.06 | Staples 24/6 mm, 1000 pcs. | 3,58 |
| 2000.08 | Staples 24/8 mm, 1000 pcs. | 3,58 |
| 2001 | Hand-stapler for 4 - 14 mm staples | 13,55 |
| 2001.06 | Staples for No. 2001, 6 mm, 1000 pcs.. | 1,86 |
| 2001.06 | Staples for, No. 2001 6 mm, 5000 pcs. | 7,10 |
| 2001.08 | Staples for No. 2001, 8 mm ,1000 pcs. | 2,00 |
| 2001.10 | Staples for No. 2001, 10 mm ,1000 pcs. | 2,25 |
| 2001.12 | Staples for No. 2001, 12 mm, 1000 pcs. | 2,35 |
| 2001.14 | Staples for No. 2001, 14 mm ,1000 pcs. | 2,50 |
| 2002 | Professional hand stapler and tack-gun | 44,92 |
| 2001.06 | Staples for No. 2002 , 6 mm, 5000 pcs. | 9,66 |
| 2001.08 | Staples for No. 2002, 8 mm, 5000 pcs. | 10,56 |
| 2001.10 | Staples for No. 2002, 10 mm, 5000 pcs. | 11,22 |
| 2001.SKN15 | Nails for No. 2002, 15 mm, 10000 pcs. | 37,00 |



1999

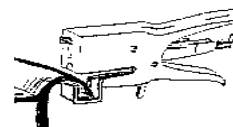

1999 mit Winkelamboß



2000

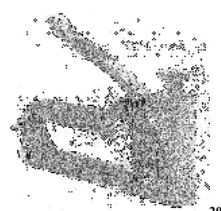

2001

211 Air-pressure Stapler & Nail-guns

We gladly send You our ITW Haubold supplement on demand.

| Art. No. | Article name | Prices ex VAT. (€) |
|-------------------------------------|---|-----------------------|
| 230 Needles & Pins | | |
| 2220 | Strong pins with colourd plastic heads 100 pcs. | 6,66 |
| 2240 | Extra strong plastic headed pins size 4/0, 100 pcs. | 7,14 |
| 2250 | Upholsterers pins, 65 mm, 100 pcs. | 8,42 |
| Scratch awl blades | | |
| 2300 | .150 mm | 3,10 |
| 2300 | .175 mm | 3,88 |
| 2300 | .200 mm | 3,62 |
| 2300 | .250 mm | 4,05 |
| Shoemakers steelwire needles, | | |
| 2310 | 0,3 x 100 mm 1 pce / 10 pcs / 50 pcs | 1,15 / 9,50 / 33,25 |
| 2310 | 0,5 x 100 mm 1 pce / 10 pcs / 50 pcs | 1,21 / 10,11 / 35,39 |
| 2310 | 0,5 x 200 mm 1 pce / 10 pcs / 50 pcs | 4,30 / 34,40 / 129,00 |
| 2320 | Hookpoint needles | 2,10 |
| 2350 | Abheft-Hohnadel Klammern für Abheftnadel | 15,85 |
| | .k.100 Stück | 2,05 |
| | .k.1000 Stück | 16,36 |
| 2420.S | Carpet needle 2/0, 54 mm, sharp (25 pcs) | 2,75 |
| 2440 | Carpet needle 4/0, 60 mm, sharp (25 pcs) | 2,66 |
| Saddlers/Harness Needles, blunt | | |
| 2507 | No. 7 43 mm | 25 pcs. 2,64 |
| 2505 | No. 5 48 mm | dto. 2,80 |
| 2503 | No. 3 54 mm | dto. 2,64 |
| 2501 | No. 1 60 mm | dto. 2,64 |
| 2520 | No. 2/0 70 mm | dto. 3,60 |
| 2540 | No. 4/0 80 mm | dto. 4,50 |
| 2550 | No. 5/0 100 mm | 12 pcs. 16,38 |
| 2550.1 | No. 5/0 100 mm | 1 pce. 1,82 |
| 2506 | No. 6 S & U 40 mm | 25pcs. 2,40 |
| 2504 | No. 4 S & U 48 mm | dto. 2,50 |
| 2502 | No. 2 S & U 56 mm | dto. 2,75 |
| Straight single round point needles | | |
| 2570 | .100 100 mm | 25 pcs 21,75 |
| 2570 | .100.1 100 mm | p. pce 1,04 |
| 2570 | .125 125 mm | 25 pcs. 29,00 |
| 2570 | .125.1 125 mm | p. pcs 1,42 |
| 2570 | .150 150 mm | 25 pcs 41,25 |
| 2570 | .150.1 150 mm | p.pce 1,98 |
| 2570 | .200 200 mm | 25 pcs 60,75 |
| 2570 | .200.1 200 mm | p.pce 2,92 |
| 2570 | .300 300 mm | 25 pcs 124,75 |
| 2570 | .300.1 300 mm | p.pce 5,99 |

| Art. No. | Article name | | Prices ex VAT (€) |
|---------------------------------------|--|---------|-------------------|
| 230 Needles & Pins (cont.) | | | |
| | Straight double round point needles | | |
| 2590.08 | 8", 200 mm | p.pce | 3,24 |
| 2590.12 | 12", 300 mm | p.pce | 4,50 |
| 2590.14 | 14", 350 mm | p.pce | 5,76 |
| 2590.18 | 18", 450 mm | p.pce | 7,79 |
| | Glovers Needles | | |
| 2601 | No. 1 48 x 1 mm | 25 pcs. | 16,88 |
| 2603 | No. 3 43 x 0,9 mm | dto. | 6,75 |
| 2605 | No. 5 39 x 0,8 mm | dto. | 6,75 |
| 2620 | No. 2/0 53 mm | dto. | 8,75 |
| 2640 | No. 4/0 57 mm | dto. | 6,88 |
| | Glovers needles unpacked | | |
| 2600 | .lose per No. | | |
| | Curved round pointed needles | | |
| 2740 | No. 40 | 25 pcs | 33,50 |
| 2765 | No. 65 | dto. | 17,25 |
| 2780 | No. 80 | dto. | 18,25 |
| 2790 | No. 90 | dto. | 21,25 |
| 2780.W | No. 80 nickle plated, wide curve | dto. | 18,00 |
| 2790.W | No. 90 nickle plated, wide curve | dto. | 21,00 |
| 2800 | No. 100 | dto. | 23,00 |
| 2800.W | No. 100 nickle plated, wide curve | dto. | 22,75 |
| | Lampshade-round point needles 1/2 | | |
| 2900.50 | No. 50 | 25 pcs. | 16,00 |
| 2900.75 | No. 75 | dto. | 18,25 |
| 2900.100 | No. 100 | dto. | 23,75 |
| 2900.125 | No. 125 | dto. | 29,75 |
| 2900.150 | No. 150 | dto. | 32,00 |
| 2900.200 | No. 200 | dto. | 48,45 |
| 2900.250 | No. 250 | dto. | 70,75 |
| 2976 | Lampshade-round pointed needle 3", extra large eye | 25 pcs | 14,95 |
| 3000 | Curved round pointed needles unpacked, up to size 100, | p.pce | 1,80 |
| 3155 | Lacing needle | p.pce | 1,20 |
| 3155 | .10 dto. | 10 pcs | 9,60 |
| | Lacing needle screw-in end, brass | | |
| LF1193 | .01 small | | 4,00 |
| LF1193 | .02 large | | 4,00 |
| 3218 | Open end thimble stainless steel , d = 18mm | p.pce | 0,95 |
| 412 | Automatic awl „Cz“ | | 13,80 |
| 412 | .ES Spare spool for No. 412 | | 3,90 |

Additional curved needles f.e. Articl Nos. 503 / 553 look up the Osborne supplement!

| Art. No. | Article name | | Prices ex VAT. (€) |
|---------------------------------------|---|-----------|--------------------|
| 230 Needles & Pins (cont.) | | | |
| 413 | Automatic awl „Osborne“ "the little sewing machine" complete with needle & thread | | 27,80 |
| 413 | -N5 Spare needle, small | | 5,40 |
| 413 | -N8 Spare needle, large | | 5,40 |
| 413 | -N6 Spare needle, curved | | 5,40 |
| | Spare spools, thread included | | |
| 413 | -R-B ,small, black yarn | | 7,20 |
| 413 | -R-BR, small, brown yarn | | 7,20 |
| 413 | -R-W, small, white yarn | | 7,20 |
| 413 | -ST, medium, black, brown or white yard | | 36,40 |
| | Use Nylontwine No. 11/2 as substitute. | | |
| | Sewing kit „Das Sattlersäckchen“ Contains 2 awls& hafts, wachs, threads, div. needles, etc. | | |
| 3251 | per kit | | 22,80 |
| 3260 | Sorted needles set, 6 different needles | | 1,89 |
| 190075 | Wire pusher for shoemakers sewing machine (f.e Adler 30-1) | | 1,65 |
| 3100 | Sewing machine needles Systems 794, 328, 332, 134, 134-35 deliverable from 10 pcs. | | |
| 3100.794R | Round pointed | 100 pcs. | 69,76 |
| 3100.794LR | sharpened right point | 100 pcs. | 91,50 |
| 3100.794LL | sharpened left point | 100 pcs. | 95,22 |
| 3100.794S | Spade point | 100 pcs. | 113,12 |
| 3100.328R | Round pointed | 100 Stück | 55,36 |
| 3100.328LR | sharpened right point | 100 Stück | 79,80 |
| 3100.328LL | sharpened left point | 100 Stück | 79,80 |
| 3100.328S | Spade point | 100 Stück | 89,64 |
| 3100.332R | Round point | 100 Stück | 25,80 |
| 3100.332LR | sharpened right point | 100 Stück | 35,10 |
| 3100.332LL | sharpened left point | 100 Stück | 35,10 |
| 100.332LG | Round point long shaft | 100 Stück | 50,10 |
| 3100.332LRLG | sharpened point right, long shaft | 100 Stück | 87,00 |
| 3100.332LLG | sharpened point left, long shaft | 100 Stück | 73,20 |
| 3100.134R | Round point | 100 Stück | 28,95 |
| 3100.134LR | sharpened right point | 100 Stück | 37,80 |
| 3100.134-35R | round point | 100 Stück | 30,16 |
| 3100.134-35LR | sharpened right point | 100 Stück | 32,86 |
| 3100.134-35LL | sharpened left point | 100 Stück | 41,64 |

Other machine needles on demand.

**Please add needle strength to nneedle number when You place Your order.
f.e.: strength 160 equals 1,6mm shaft width.**

Art. No. Article name Prices ex VAT. (€)

240 Sharpening tools, whetstones and machinery

| | | |
|---------------|---|-------|
| 190001 | Quality-whetstone 125 x 50 x 20 mm, sharpening & polishing with oil or water | 15,00 |
| | Original „Belgian Whetstone“, Coticule | |
| 190002 | .100 x 40 mm cut rectangular stone | 20,00 |
| 190002 | .6 ca. 6 cm ² broken stone filed in form | 17,00 |
| 190002 | .10 ca. 10 cm ² broken stone filed in form | 29,80 |

| | | |
|-----------------|---|-------|
| | Sharpening steel rod, chrome-vanadium steel, Solingen | |
| 3320.20 | 21 cm (magnetic) | 20,00 |
| 3320.30 | 30 cm (magnetic) | 23,25 |
| 3320.31 | 31 cm (magnetic), oval | 29,95 |
| 3320.7,5 | 7,2 cm Pocket sharpening steel | 13,80 |



3320.21- .26

| | | |
|-------------------|---|--------------|
| SM100 | Sharpening machine DICK SM-100 (to sharpen knives, scissors, etc.) | |
| NEU | Power 500 Watts; 2980 U/min; 240 V incl. 1 x little bar of polish + 1 sanding belt | netto 315,00 |
| SM100.3639 | Bar of polish white 0,5 kg | netto 5,30 |
| SM100.3647 | K080 sanding belt 55 x 1020 mm | netto 3,46 |
| | K100 sanding belt 55 x 1020 mm | netto 3,46 |
| | K100 sanding belt 55 x 1020 mm | netto 3,46 |
| SM100.3648 | Felt polishing wheel 200 x 25 mm | netto 36,75 |



| | | |
|-------------|---|--------------|
| 3410 | Sharpening machine „MADO-Universal“ USM 525 D As No. 3410, but with High power cord Power: 250 Watts; 220 V / 380 V (delivery without socket!) | netto 540,00 |
| 3411 | Bar of polish 0,5 kg | netto 11,40 |
| 3430 | Oil for belt grinder/sander | netto 21,60 |
| 3420 | Felt polishing wheel 125 mm | netto 16,50 |

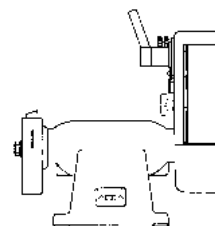

3409 + 3410

| | | |
|--------------------|---|------------|
| | Sanding belts for Nos. 3409/3410 | |
| 3400.060 | 710 x 45 mm, Korn: 60 | netto 3,00 |
| 3400.080 | 710 x 45 mm, Korn: 80 | netto 3,00 |
| 3400.80EQ | 710 x 45 mm, Korn: 80 | netto 3,13 |
| 3400.100 | 710 x 45 mm, Korn: 100 | netto 3,00 |
| 3400.100EQG | 715 x 50 mm, Korn: 100 | netto 3,13 |
| 3400.120 | 710 x 45 mm, Korn: 120 | netto 3,00 |
| 3400.150 | 710 x 45 mm, Korn: 150 | netto 3,00 |
| 3400.150EQ | 710 x 45 mm, Korn: 150 | netto 3,13 |
| 3400.240 | 710 x 45 mm, Korn: 240 | netto 3,21 |
| 3400.240EQ | 710 x 45 mm, Korn: 240 | netto 3,13 |

EQ = Extra Quality- longer durability

Other sharpening machines on demand!.

245 Rough scratchers & files

| | | |
|----------------|--|-------|
| 3460.SF | Set of Keyfiles includes 6 files, 100 mm | 10,96 |
| 3461 | Set of files includes 4 files, 200 mm | 22,26 |
| 3465 | Set of woodfiles, includes 3 files 8" long | 6,39 |
| 3470 | Simple rough scratching brush | 4,16 |
| 3471 | rough scratching brush, with patent handle | 29,96 |
| 3471.1 | Spare scratch pad for No. 3471 | 5,66 |



3470



3471



| Art. No. | Article name | Prices ex VAT. (€) |
|------------------|---|--------------------|
| 260 | Glues, dyes, wachs, pitch, grease, oil, soap | |
| | Bone glue, fine pearl pellets | |
| 3500 | 250 g bag | 5,90 |
| 3500 | 1,5 kg bag | 22,13 |
| 3500 | from 5 kg, per kilo | 12,98 |
| 3500 | from 25 kg, per kilo | 11,80 |
| 3503 | Arabic gum, price per kg | 38,70 |
| 3503 | .100 g bag of Arabic gum | 10,40 |
| 3504 | Colophonium powder, price per kilo | 37,00 |
| 3505 | Rubber solvent, 580 g Dose | 12,05 |
| 3506.05 | Aquilim. dispersion glue, solvent free , 0,5 kg | 13,82 |
| 3506.3 | Aquilim. dispersion glue, solvent free , 3,0 kg | 56,78 |
| 3507 | Finest talcum powder price per kilo | 10,50 |
| 3508 | „Hirschkleber“, solvent free leather cement 600 g Jelly consistency | 7,10 |
| 3509.500 | Spray glue, 500 ml | 8,84 |
| 3510.1 | „Syntic-Total“ plastic glue, glues even PVC 640 g container | 16,56 |
| 3519.1+P | “Colle de Cologne” universal contact glue, 1 l Good as Sole-cement for shoes! | 15,87 |
| | “Vulkofest“, universal contact glue (PVC excluded!!) | |
| 3520.1+P | 1 l container, 0,81 kg netto | 14,50 |
| 3520.4 | 4,94 l container, 4,0 kg netto | 61,56 |
| 3520.10 | 12,35 l container, 10 kg netto | 126,96 |
| 3521 | Solvent, 1 Liter netto | 11,76 |
| 3544.0050 | Glue-hardener for Vulkofest (increases heat-resisting abilities), 50 ml, netto | 6,56 |
| | “Klebfest“ universal glue for leathers, rubber, kork, felt, metall, wood etc. | |
| 3530.2 | 60g Tube netto | 3,74 |
| 3530.3 | 90g Tube netto | 5,56 |
| 3535.1 | “Edelkit“, for wet-glueing, 1 l ideal for transmission belts, shoe-soles etc. | 15,87 |
| | Superglue, “Proto Colle” flexible | |
| 3540 | .20 ml Flask netto | 4,02 |
| 3540 | .50 ml Flask netto | 8,46 |
| | Aceton- cleaner and solvent | |
| 3522 | .0050 ml Flask netto | 1,94 |
| 3522 | .1 Liter container netto | 9,30 |
| 3523 | „de Sohl“ sole remover netto | 11,76 |
| | Saddler’s pitched wax | |
| 3600.20 | small bar (ca. 20 g) | 2,10 |
| 3600 | large bar (ca. 100 g) | 4,29 |
| 3600.1 | 10 large bars (1000 g) | 39,00 |
| 3600.2 | from 100 bars / special sale | 292,50 |
| 3610 | ROC Saddler’s pitched wax, 110 g | 6,72 |

| Art. No. | Article name | Prices ex VAT. (€) |
|---|--|--------------------|
| 260 Glues, dyes, wachs, pitch, grease, oil, soap (cont.) | | |
| 3650 | Cobbler`s pitch PP 75 black ca. 150 g | 3,28 |
| 3652 | Cobbler`s pitch PP 12, light ca. 150 g | 2,16 |
| 3652.10 | Cobbler`s pitch PP 12, light 10 kg container | on demand |
| | Liquid pitch (for sewing machine oil-containers) | |
| 16.3.60350 | Liquid pitch, yellow, 0,9 kg Dose | 17,50 |
| 16.3.90000.1000 | Liquid pitch,solvent 1 Liter | 16,25 |
| | Wax-pens (for grain-side-damaged leathers) | |
| 3700 | Set of 3: black, medium brown, dark brown | 12,30 |
| 3700.1 | Wax-pen, black, 145 g | 4,33 |
| 3700.2 | Wax-pen, medium brown, 145 g | 4,33 |
| 3700.3 | Wax-pen, dark brown 145 g | 4,33 |
| 3700.5 | Wax-pen, light-transparent brown, 145 g | 4,33 |
| | Leathersoftener | |
| 3702.1 | 1l | 12,04 |
| 3702.5 | 5l | 46,00 |
| | Shoe polish „Solitär Brillant“ | |
| 3703 | .1 black, 75 ml | 6,80 |
| 3703 | .2 dark brown, 75 ml | 6,80 |
| 3703 | .3 medium brown, 75 ml | 6,80 |
| 3703 | .4 transparent, 75 ml | 6,80 |
| | Leather polish „Rapide“ | |
| 3699. | .250 ml | 10,20 |
| | Anilin-powder (Dye for edge-dye out of bone-glue) | |
| 3705.1 | 20 g black | 5,00 |
| 3705.1. | 250 g black | 37,50 |
| 3705.1. | 1000 g black | 100,00 |
| 3705.2 | 20 g brown (negro) | 5,00 |
| 3705.2. | 250 g brown (negro) | 37,50 |
| 3705.2 | 1000 g brown (negro) | 100,00 |
| 3705.4 | 1000 g red-brown (redwood) | 100,00 |
| 3705.5 | 20 g london colour | 5,00 |
| 3705.5. | 250 g london colour | 37,50 |
| 3705.5. | 1000 g london colour | 100,00 |
| 3707 | “Gold Quality”- beeswax-leathergrease, 230 ml tin | 9,38 |
| 3718 | .125 ml tin synthetic leathergrease, Top Quality | 9,91 |
| 3709 | Leathergrease "KoChoLine", 225 g tin | 9,40 |
| | Leather soap „Rapide Leather Soapie“ | |
| 3708 | .500 ml tin | 11,12 |
| 3708 | .5000 ml container | 78,80 |
| | Leather-oil “Rapide”, transparent | |
| 3719 | .0100 ml | 5,00 |
| 3719 | .1 Liter | 13,90 |
| 3719 | .5 Liter | 53,00 |
| 3719 | .10 Liter | 99,90 |
| | Leather-oil “Rapide”, black | |
| 3719.0100.S | 100 ml | 5,00 |
| 3719.1.S | 1 Liter | 13,90 |

| Art. No. | Article name | Prices ex VAT. (€) |
|---|---|--------------------|
| 260 Glues, dyes, wachs, pitch, grease, oil, soap (cont.) | | |
| | “Ballistol” universal oil | |
| 11.2.2182 | .25 ml spray-tin | 1,26 |
| 11.2.2184 | .50 ml spray-tin | 2,52 |
| 11.2.21850 | .200 ml spray-tin | 5,46 |
| 11.2.21000 | .50 ml bottle | 2,51 |
| 11.2.21150 | .500 ml bottle | 10,50 |
| 11.2.21990 | Ballistol nostalgic-box “ Jäger “ | 16,00 |
| 11.2.23651 | Ballistol – Kit , “Weapon-tending”-to go | 29,41 |
| 11.2.23650 | Ballistol –Box , “Weapon-tending” | 42,00 |
| 11.2.2514.100 | Ballistol Kamofix, pump spray, 100 ml | 3,35 |
| B.2.2514.600 | Ballistol Kamofix, with spray-head, 600 ml | 12,52 |
| 11.2.26831.600 | Ballistol Stichfrei Animal (anti-mosquito), 600 ml | 21,00 |
| 11.2.2659.T10 | Ballistol Animal, tissues, 10 Stück | 5,00 |
| 11.2.2656.10 | Ballistol Animal, 10 ml | 2,26 |
| 11.2.2651.100 | Ballistol Animal, 100 ml | 4,90 |
| 11.2.26800 | .100 ml Ballistol Stichfrei, pump-spray | 6,49 |
| 11.2.2681 | .125 ml Ballistol Stichfrei, Spray-tin | 6,04 |
| 11.2.26820 | .500 ml Ballistol Stichfrei, Spray-tin | 19,82 |
| 11.2.26815 | .30 ml Ballistol Stichfrei “ KIDS”, Tube | 3,99 |
| 11.2.26816 | .125 ml Ballistol Stichfrei “ KIDS”, pump-spray | 9,99 |
| 11.2.26840 | .10 ml Ballistol household oil | 1,98 |
| 11.2.26840 | .50 ml Ballistol household oil | 4,31 |
| 11.2.26200 | .100 ml Ballistol household oil | 5,03 |

| Art. Nr. | Warenbezeichnung | Preise ohne MwSt. (€) |
|---|---|-----------------------|
| 260 Glues, dyes, wachs, pitch, grease, oil, soap (cont.) | | |
| 190071 | Oil for sewing machine maintenance | |
| | .250 ml | 3,32 |
| | .1l | 11,88 |
| 3525 | Plastic cleaner | |
| | .250 ml | 4,74 |
| KI32.08 | Ducttape, 50 m, schwarz | 8,33 |
| | Edge-dye (cold-polish), 10 l container | |
| 3711 | .0. transparent | 198,00 |
| 3711 | .1. black | 198,00 |
| 3711 | .2 dark brown | 204,00 |
| 3711. | “Mattierung“ Anti-gloss edge-dye | 13,60 |
| | Custom dyes on demand & sample! | |
| | Edge-dye ROC (cold-polish) | |
| 3715 | .0.025 transparent (0,25 l) | 13,83 |
| 3715 | .1.025 black (0,25 l) | 13,83 |
| 3715 | .2.025 brown (0,25 l) | 13,83 |
| 3715 | .5.025 london- colour brown (0,25 l) | 13,83 |
| | Edge-dye ROC (cold-polish) | |
| 3715 | .0.1 transparent (1 l) | 32,90 |
| 3715 | .1.1 black (1 l) | 32,90 |
| 3715 | .2.1 brown (1 l) | 32,90 |
| 3715 | .5.1 london-colour brown (1l) | 32,90 |
| | Edge-dye ROC (cold-polish) | |
| 3715 | .0.5 transparent (5 l) | 147,70 |
| 3715 | .1.5 black (5 l) | 147,70 |
| 3715 | .2.5 brown (5 l) | 147,70 |
| 3715 | .5.5 london-colour brown (5 l) | 147,70 |
| | Leather-sealing "Perafoline", 1 l Flasche | |
| 3720 | .1 transparent (to seal embossing and carving works) | 22,20 |
| 3720 | .2 dark brown | 22,20 |
| 3720 | .3 black | 22,20 |
| 3720.V | .025 „Perafoline“- solvent „KIRSOLV“ | 5,78 |
| | „Morello“ leather-dye, 40 ml | |
| 3721 | .948 brown | 4,53 |
| 3721 | .951 dark brown | 4,53 |
| 3721 | .960 black | 4,53 |
| | Different colours on demand | |
| 3730 | „Morello Extraschwärze“ fuel-based dye black 1.000 ml | 24,09 |
| FB1107-01 | Fiebings Prof. Oil Dye, black, 946 ml | 48,08 |
| FB1107-02 | darkbrown, 946 ml | 49,00 |
| FB1126-01 | Fiebings Neatfood Oil 946 ml | 26,44 |
| 3735 | „Renia Spezial“ Leather-dye, black, 1.000 ml | 25,54 |

| Art. Nr. | Warenbezeichnung | Preise ohne MwSt. (€) |
|---|---|-----------------------|
| 260 Glues, dyes, wachs, pitch, grease, oil, soap (cont.) | | |
| | ROC Leathe-topcoat dye, (f.e.wedding-coach harnesses) | |
| 3722.4 | .1 1 Liter, white | 92,75 |
| 3722.4 | .025 0,25l, white | |
| | ROC leather-dyes, 0,25 l bottle | |
| 3725 | .1 black | 12,95 |
| 3725 | .2 dark brown | 12,95 |
| 3725 | .3 read brown | 12,95 |
| 3725 | .4 yellow brown | 12,95 |
| 3725 | .5 tan (light readbrown) | 13,40 |
| 3725 | .6 (extra) dark brown | 12,95 |
| 3725 | .7 red | 13,40 |
| 3725 | .8 blue | 13,40 |
| 3725 | .9 navy-blue | 12,95 |
| 3725 | .10 green | 12,95 |
| 3725 | .11 yellow | 13,40 |
| 3725 | .12 violet | 12,95 |
| 3725 | .13 cyklamen | 12,95 |
| 3725 | .14 mahogani | 12,95 |
| 3725 | .15 orange | 12,95 |
| 3725 | .16 olive | 12,95 |
| 3725 | .17 lime | 12,95 |
| | ROC leather-dye, 1 l container | |
| 3725 | .1.1 black | 25,75 |
| 3725 | .2.1 darkbrown | 25,75 |
| 3725 | .3.1 redbrown | 25,75 |
| 3725 | .6.1 (extra) darkbrown | 28,00 |
| | Other colours in larger quantities (1l) on demand | |
| | Dye applying wad-ball on a stick | |
| 3716 | .001 1pce | 0,50 |
| | .010 10 pcs | 3,58 |
| | .100 100 pcs | 28,60 |

| Art. No. | Article name | Prices ex VAT. (€) | |
|--|---|--------------------|---|
| 270 Health & Safety | | | |
| 266 | Sewing palm "Osborne" (sailmaker's glove), Lighter version (L= for left-handed personel) | 20,20 |  266 |
| JF18 | Thimble, 18 mm | 1,00 | |
| 3.918 | Stitch-plate for Sailmaker's glove „Blanchard“ | 3,89 | |
| 72 | Knife scabbard "Osborne" | 16,20 | |
| | Dusk mask | | |
| 3750 | 5 Stück / bagged | 2,30 | |
| 3750.2 | 50 Stück / cardboard blister | 19,17 | |
| 3745 | Set: Eye protector, ear protectors & dusk mask | 9,61 | |
| 25.1.130.08 | Blue-nopped light working gloves, size. 8 | 1,70 | |
| 25.1.400.89 | Blue-nopped cotton working gloves, size 9 | 3,90 | |
| 280 Containers, cutting and punching Boards | | | |
| | Glue-containers incl. brush | |  3545.045-.150 |
| 3545 | .045 0,45 Liter | 17,95 | |
| 3545 | .090 0,90 Liter | 25,03 | |
| 3545 | .150 1,5 Liter | 26,65 | |
| 3545 | .300 3,0 Liter | 30,75 | |
| | Spare brush | | |
| 3545 | .045P für 0,45 l | 2,18 | |
| 3545 | .090P für 0,90 l | 3,40 | |
| 3545 | .150P für 1,50 l | 3,02 | |
| 3550 | Polyaethylaen-bottles, wide neck, screw stopper 69 mm Hole | | |
| | .0500 500 ml | 1,68 | |
| | .1000 1000 ml | 1,76 | |
| 3550 | .D80 Spare stopper | 0,51 | |
| W06.865 | Oil can, 0,25 l | 6,40 | |
| 190008 | Foldback-Clips, 50 pcs. (32 x 19 mm, 12 x 25, 2 x 32 mm) | 13,08 |  190010 - 190012 |
| | .19 mm, 12 pcs. | 4,88 | |
| | .25 mm, 12 pcs. | 7,98 | |
| | .32 mm, 12 pcs. | 10,18 | |
| | Metal textile clips | | |
| 190011 | length 170 mm, mouth 60 mm wide | 14,73 | |
| 190012 | length 200 mm, mouth 65 mm wide | 16,36 | |
| 190014 | Universal clip, length 100 mm, mouth 18 mm wide | 1,60 | |
| 190015 | Universal clip, length 150 mm, mouth 25 mm wide | 3,06 | |
| SBGS829 | Screw-clamp, 200 x 50 mm | 2,40 | |

| Art. No. | Article name | Prices ex VAT. (€) |
|--|--|--------------------|
| 280 Containers, cutting and punching Boards (cont.) | | |
| 3770 | Sewing knee-clamp „BLANCHARD, Paris“ 1,05 m | 98,80 |
| 3771 | 1,30 m | 129,00 |
| 3784 | Knee-clamp with horns | 76,00 |
| 3783 new model | foldable knee-clamp | 84,00 |
| 3782 | Knee-clamp, old French form, tropical hardwood With slightly-curved clamps | 140,00 |
| 3785 | Clamp with foot-spring handle, for working tables | 168,73 |
| 3790 | Small table-adjustment clamp | 116,00 |
| 3791 | small sewing clamp | 61,90 |
| 3792 | simple small sewing-clamp | 27,30 |
| 3781.F | Stitching horse with foot-lever | 460,00 |
| 3781.S | Stitching horse with screw-lock | 410,00 |
| 3781.S.WK | Stitching horse, screw-locked incl.tool-case | 420,00 |
| 603 | Cutting-board "Osborne" 254 x 245 x 13 mm, Vinyl | 46,80 |
| 604 | Cutting board "Glasklar A" per m/ per length 5 mm x 1100 mm | 172,00 |
| 605. | Cutting board "Hydrosolit" | |
| | 250 x 250 x 25 mm | 15,00 |
| | 600 x 500 x 25 mm | 73,70 |
| | 700 x 500 x 25 mm | 88,00 |
| | 1000 x 500 x 25 mm | 114,00 |
| | 250 x 250 x 50 mm | 28,50 |
| | 600 x 500 x 50 mm | 116,60 |
| | 700 x 500 x 50 mm | 135,26 |
| | 1000 x 500 x 50 mm | 184,00 |
| 605. | Extra small: 55 x 85 x 20 mm | 4,00 |
| | Custom boards up to 2700 x 1350 mm (One piece) or largerr (welded) on demand. <u>Thickness 25 oder 50 mm.</u> | |
| LF 3101-00 | Mini anvil (LxBxH ca. 13,3 x 4,6 x 6,6 cm, ca. 0,9kg) | 23,40 |

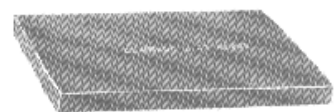

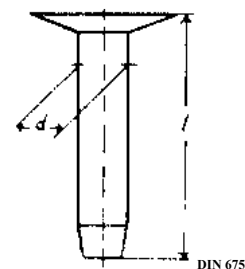

| Art. No. | Article name | Prices ev VAT. (€) |
|---|--|--------------------|
| 290 Nails, rivets, eyelets & snaps | | |
| | Blue-tempered, sharned tacks | |
| 3799 | .10 mm 1kg | 19,50 |
| 3799 | .12 mm 1kg | 17,80 |
| 3799 | .14 mm 1kg | 16,50 |
| 3799 | .16 mm 1kg | 13,30 |
| 3799 | .18 mm 1kg | 12,90 |
| 3799 | .20 mm 1kg | 12,70 |
| 3800 | small tacks, 3,4 x 20 mm, 500 g Beutel | 4,76 |
| | Copper flathead rivet DIN 675 , 12 x 4 mm | |
| 3812.0 | p.pce | 0,28 |
| 3812 | .100 pcs /bagged | 20,00 |
| 3812 | .250 pcs /bagged | 40,00 |
| 3812 | .1000 pcs /bagged | 100,00 |
| | Copper flathead rivet DIN 675 , 15 x 4 mm | |
| 3815.0 | p.pce | 0,25 |
| 3815 | .100 pcs / bagged | 17,10 |
| 3815 | .250 pcs / bagged | 34,20 |
| 3815 | .1000 pcs / bagged | 85,50 |
| | Copper flathead rivet DIN 675 , 20 x 4 mm | |
| 3820.0 | p.pce | 0,31 |
| 3820 | .100 pcs / bagged | 21,80 |
| 3820 | .250 pcs / bagged | 43,60 |
| 3820 | .1000 pcs / bagged | 109,00 |
| | Copper flathead rivet DIN 675 , 25 x 4 mm | |
| 3825.0 | p.pce | 0,35 |
| 3825 | .100 pcs /bagged | 25,00 |
| 3825 | .250 pcs / bagged | 50,00 |
| 3825 | .1000 pcs / bagged | 125,00 |
| | Copper flathead rivet DIN 675 , 30 x 4 mm | |
| 3830.0 | p.pce | 0,35 |
| 3830 | .100 pcs / bagged | 25,00 |
| 3830 | .250 pcs / bagged | 50,00 |
| 3830 | .1000 pcs / bagged | 125,00 |
| | Different shafts on demand. | |
| | Copper washers, 4 mm Bohrung, 1,5 mm stark | |
| 3844.0 | p.pce | 0,28 |
| 3844 | .100 pcs / bagged | 19,70 |
| 3844 | .250 pcs/ bagged | 39,40 |
| 3844 | .1000 pcs / box | 86,70 |
| | Aluminum flathead rivet DIN 675 , 20 x 4 mm | |
| 3840.0 | p.pce | 0,10 |
| 3840. | .250 pcs / bagged | 10,75 |
| 3840. | .1000 pcs / box | 32,20 |
| | Aluminum flathead rivet DIN 675 , 25 x 4 mm | |
| 3841.0 | p.pce | 0,11 |
| 3841 | .100 pcs / bagged | 7,77 |
| 3841 | .250 pcs / bagged | 12,00 |
| 3841 | .1000 pcs / box | 34,00 |

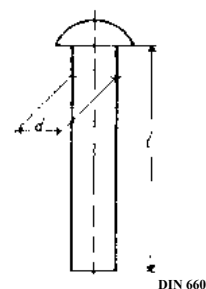

| Art. No. | Article name | Prices ev VAT. (€) |
|---|--|--------------------|
| 290 Nails, rivets, eyelets & snaps (cont.) | | |
| | Aluminum flathead rivet DIN 675 , 30 x 4 mm | |
| 3842.0 | p.pce | 0,12 |
| 3842 | .100 pcs / bagged | 8,47 |
| 3842 | .250 pcs / bagged | 13,00 |
| 3842 | .1000 pcs / box | 36,20 |
| | Aluminum washers, 4 mm Bohrung | |
| 3854.0 | p.pce | 0,12 |
| 3854 | .100 pcs / bagged | 10,20 |
| 3854 | .250 pcs. / bagged | 17,00 |
| 3854 | .1000 pcs / box | 42,50 |
| | Steel washers, 4 x 12 x 1,5 | |
| 3864.4x12x1,5.0 | p.pce | 0,14 |
| 3864.4x12x1,5 | .1000 pcs / box | 57,00 |
| | Steel washers , 5x 10 x 1,0 | |
| 3864.0 | p.pce | 0,10 |
| 3864. | .100 pcs / bagged | 6,00 |
| 3864. | .1000 pcs / box | 39,50 |
| | Iron round-head rivets, DIN 660 (f.e. for stirrup bars) | |
| 3831 | .001 pce 25 x 4 mm | 0,20 |
| 3831 | .100 pcs 25 x 4 mm | 10,50 |
| 3831 | .250 pcs 25 x 4 mm | 12,30 |
| 3831 | .1000 pcs 25 x 4 mm | 30,80 |
| | Iron round-head rivets DIN 660 | |
| 3835 | .001 pce 30 x 5 mm | 0,36 |
| 3835 | .100 pcs 30 x 5 mm | 18,87 |
| 3835 | .250 pcs 30 x 5 mm | 22,20 |
| 3835 | .1000 pcs 30 x 5 mm | 55,00 |
| | Iron round-head rivets DIN 660 (f. e. for gulleets) | |
| 3833 | .001 pce 30 x 6 mm | 0,40 |
| 3833 | .100 pcs 30 x 6 mm | 21,51 |
| 3833 | .250 pcs 30 x 6 mm | 25,30 |
| 3833 | .1000 pcs 30 x 6 mm | 63,30 |
| | Copper flathead rivet DIN 675 , 15 x 3 mm | |
| 3801.153.0 | p.pce | 0,20 |
| 3801.153 | .100 pcs / bagged | 9,72 |
| 3801.153 | .250 pcs / bagged | 18,20 |
| 3801.153 | .1000 pcs / bagged | 48,60 |
| | Copper round-head rivet, 10 x 3 mm | |
| 3804.103.0 | p.pce | 0,16 |
| 3804.103 | .100 pcs / bagged | 8,50 |
| 3804.103 | .250 pcs / bagged | 10,00 |
| 3804.103 | .1000 pcs / bagged | 20,04 |
| | Brass round-head rivet, 10 x 3 mm | |
| 3804.103CuZn36 | .250 pcs / bagged | 10,00 |
| 3804.103CuZn36 | .1000 pcs / bagged | 25,00 |
| | Copper round-head rivet & washer Washer 8x3x1 / rivet 10 x 3 mm p.pce | 3,80 |
| 3804.103 +3802.83 .10 | | |



| Art. No. | Article name | Prices ev VAT. (€) | |
|---|--|--------------------|--|
| 290 Nails, rivets, eyelets & snaps (cont.) | | | |
| | Brass washers ca. 8 x 3 x 1 mm | | |
| 3802.83-CuZn36.0 | p.pce | 0,15 | |
| 3802.83-CuZn36 | .100 pcs / bagged | 7,12 | |
| 3802.83-CuZn36 | .250 pcs / bagged | 11,13 | |
| 3802.83-CuZn36 | .1000 pcs / box | 35,60 | |
| | Copper washers, ca. 8 x 3 x 1 mm | | |
| 3802.83.0 | p.pce | 0,13 | |
| 3802.83 | .100 pcs / bagged | 9,60 | |
| 3802.83 | .250 pcs / bagged | 20,00 | |
| 3802.83 | .1000 pcs / box | 64,00 | |
| | Hollow rivets | | |
| 3849 | Hollow rivets (polished brass) <u>Caps & pegs packed 20 each</u> | | |
| .UK7 | cap 7 mm / peg 7 x 7 mm | 2,62 | |
| .UK9 | cap 9 mm / peg 7 x 9 mm | 3,41 | |
| 3849.OT307+UT813 | Brass-escutcheon fasteners 100 pcs | 14,58 | |
| 3850 | Hollow rivets (brass, nickle-plated) <u>Caps & pegs packed 20 each</u> | | |
| .UK5 | cap 5 mm / peg 5 x 5 mm | 1,41 | |
| .UK6 | cap 6 mm / peg 6 x 6 mm | 2,63 | |
| .UK8-7 | cap 7 mm / peg 7 x h: 8 mm | 2,05 | |
| .UK8-9 | cap 9 mm / peg 7 x h: 8 mm | 3,11 | |
| .UK-9 | cap 9 mm / peg 9 x h: 9 mm | 3,39 | |
| .UK-10 | cap 9 mm / peg 7 x h: 10 mm | 3,89 | |
| .UK12 | cap 13 mm / peg 13 x h: 12 mm | 7,46 | |
| .UK14 | cap 12 mm / peg 12 x h: 14 mm | 7,53 | |
| .UKC12 | cap 13 mm / peg 13 x h: 12 mm , closed | 10,47 | |
| 3851 | Hollow rivets (steel, nickle-plated) / pegs capped <u>Caps & pegs packed 20 each</u> | | |
| .UK15 | cap 13 mm / peg 12 x h: 14 mm | 4,41 | |
| 3849 | Hollow rivets (polished brass) | | |
| | caps | | |
| .K7 | .100 pcs 7 mm | 9,24 |  3849.K |
| | .500 pcs 7 mm | 30,80 | |
| | pegs | | |
| .U7 | .100 pcs 7 x 7 mm | 5,25 |  3849.U |
| | .500 pcs 7 x 7 mm | 19,50 | |
| | caps | | |
| .K9 | .100 pcs 9 mm | 11,70 | |
| | .500 pcs 9 mm | 33,00 | |
| | pegs | | |
| .U9 | .100 pcs 7 x 9 mm | 5,37 | |
| | .500 pcs 7 x 9 mm | 22,90 | |
| | <u>Capped pegs</u> | | |
| .UC7 | .100 pcs 7 x 7 mm | 7,95 | |
| .UC9 | .100 pcs 7 x 9 mm | 11,85 | |
| .UC14 | .100 pcs 7 x 14 mm | 22,90 | |

| Art. No. | Article name | Prices ev VAT. (€) | | |
|---|--------------------------------------|--------------------|------------|------------|
| 290 Nails, rivets, eyelets & snaps (cont.) | | | | |
| 3850 | Hollow rivets (Brass, nickle-plated) | | | |
| .K5. | caps 5 mm | | | |
| | <u>p.pcs.</u> | 5.000 | 500 | 100 |
| | netto € | 103,00 | 13,70 | 4,11 |
| .U5. | pegs 5 x 5 mm | | | |
| | <u>p.pcs.</u> | 5.000 | 500 | 100 |
| | netto € | 84,00 | 11,20 | 3,36 |
| .K6. | caps 6 mm | | | |
| | <u>p.pcs.</u> | 5.000 | 500 | 100 |
| | netto € | 131,00 | 17,50 | 5,25 |
| .U6. | pegs 6 x 6 mm | | | |
| | <u>p.pcs.</u> | 5.000 | 500 | 100 |
| | netto € | 103,50 | 13,80 | 4,14 |
| .K7. | caps 7 mm | | | |
| | <u>p.pcs.</u> | 5.000 | 500 | 100 |
| | netto € | 221,50 | 29,50 | 8,85 |
| .U7. | pegs 7 x 7 mm | | | |
| | <u>p.pcs.</u> | 5.000 | 500 | 100 |
| | netto € | 142,50 | 19,00 | 5,70 |
| .U8. | pegs 7 x 8 mm | | | |
| | <u>p.pcs.</u> | 5.000 | 500 | 100 |
| | netto € | 118,50 | 15,80 | 4,74 |
| K9. | caps 9 mm | | | |
| | <u>p.pcs.</u> | 5.000 | 500 | 100 |
| | netto € | 337,50 | 45,00 | 13,50 |
| .U9. | pegs 7 x h: 9 mm | | | |
| | <u>p.pcs.</u> | 5.000 | 500 | 100 |
| | netto € | 341,50 | 45,50 | 13,65 |
| .U10 | pegs 7 x h: 10 mm HN 337 UT M18 | | | |
| | <u>p.pcs.</u> | 5.000 | 500 | 100 |
| | netto € | 199,00 | 26,50 | 7,95 |
| .K11. | caps 11 mm | | | |
| | <u>p.pcs.</u> | 5.000 | 500 | 100 |
| | netto € | 405,00 | 54,00 | 16,20 |
| K12. | caps 12 mm | | | |
| | <u>p.pcs.</u> | 5.000 | 500 | 100 |
| | netto € | 499,00 | 66,50 | 19,95 |
| .K13. | caps 13 mm | | | |
| | <u>p.pcs.</u> | 5.000 | 500 | 100 |
| | netto € | 765,00 | 99,00 | 29,70 |
| .U12. | pegs 13 x h: 12 mm | | | |
| | <u>p.pcs.</u> | 5.000 | 500 | 100 |
| | netto € | 525,00 | 70,00 | 21,00 |
| .U14. | pegs 12 x h: 14 mm | | | |
| | <u>p.pcs.</u> | 5.000 | 500 | 100 |
| | netto € | 364,50 | 48,60 | 14,58 |
| .UC10. | pegs 11 x h: 10 mm, capped | | | |
| | <u>p.pcs.</u> | 5.000 | 500 | 100 |
| | netto € | 161,50 | 21,50 | 6,45 |
| .UC12. | pegs 13 x h: 12 mm, capped | | | |
| | <u>p.pcs.</u> | 5.000 | 500 | 100 |
| | netto € | 735,00 | 98,00 | 29,40 |



3850.K



3850.U

Art. No. Article name Prices ev VAT. (€)

290 Nails, rivets, eyelets & snaps (cont.)

| | | | | |
|--------|---|--------------|------------|------------|
| 3851 | Hollow rivets (steel, nickle-plated) / pegs capped | | | |
| .K13. | <u>caps</u> 13 mm | | | |
| | <u>p.pcs.</u> | 5.000 | 500 | 100 |
| | netto € | 169,50 | 22,60 | 6,78 |
| .U15. | <u>pegs</u> 12 x h: 14 mm | | | |
| | <u>p.pcs.</u> | 5.000 | 500 | 100 |
| | netto € | 247,50 | 33,00 | 9,90 |
| .UC12. | <u>pegs</u> 12 x h: 12 mm, capped | | | |
| | <u>p.pcs.</u> | 5.000 | 500 | 100 |
| | netto € | 269,00 | 35,90 | 10,77 |

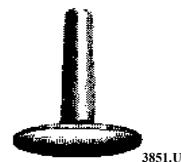

| | | | |
|-------|--|--------------|-------|
| | Upholstering-/ decorating nails | | |
| 1965. | 90 1/3 E/alt.g speckled, aged gold | je 100 Stück | 2,59 |
| 1965. | 90 1/3 E/altm brass-plated, aged | je 100 Stück | 2,59 |
| 1965. | 90 1/3 E/br.ren renaissance-bronze | je 100 Stück | 3,36 |
| 1965. | 90 1/3 E/verm. brass- plated | je 100 Stück | 2,50 |
| 1965. | 90 1/3 MB polished brass | je 100 Stück | 4,44 |
| 1965. | 100 1/3 E/br.ren renaissance-bronze | je 100 Stück | 3,50 |
| 1965. | 110 MB brass polished, 11 mm | je 100 Stück | 27,00 |
| 1965. | 110 MN brass nickle-plated, 11 mm | je 100 Stück | 27,00 |

1965. Decoration-nail tool 9,00

| | | | |
|-------------------|--|--|-------|
| | Nail-decoration strips, 1 m | | |
| 1966. | 100 1/3 E/br.ren renaissance-bronze p.pcs | | 2,60 |
| | incl. 20 upholstery nails | | |
| HE010900012170100 | Brass upholstery nails with staple Nr. 90/ 1/3 | | 28,48 |
| HE011000010127100 | Brass upholstery nails with rod Nr.100/ 1/3 | | 22,65 |

| | | | |
|------|-------------------------------|-------|-------|
| | Polished brass Chicago screws | | |
| 3855 | .5 mm (height), 10 pcs | | 8,25 |
| 3855 | .5 mm dto., 100 pcs | netto | 55,00 |
| 3855 | .7 mm dto. 10 pcs | | 5,24 |
| 3855 | .7 mm dto. 100 pcs | netto | 34,94 |
| 3855 | .10 mm dto. 10 pcs | | 9,45 |
| 3855 | .10 mm dto. 100 pcs | netto | 47,26 |

3855+3865

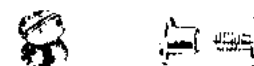

| | | | |
|------|-------------------------------------|-------|-------|
| | Brass, nickle-plated chicago screws | | |
| 3865 | .5 mm (height) 10 pcs | | 10,13 |
| 3865 | .5 mm dto. 100 pcs | netto | 67,50 |
| 3865 | .7 mm dto. 10 pcs | | 5,52 |
| 3865 | .7 mm dto. 100 pcs | netto | 36,80 |
| 3865 | .10 mm dto. 10 pcs | | 7,31 |
| 3865 | .10 mm dto. 100 pcs | netto | 48,72 |

3855+3865



| | | | |
|--------|---|-------|-------|
| M50258 | Nickle-plated brass & decorated chicago screw | | |
| | 3/8 x 3/8, 10mm 10 pcs | | 3,57 |
| | Dto. 100 pcs | netto | 23,80 |

Art. No. Article name Prices ev VAT. (€)

290 Nails, rivets, eyelets & snaps (cont.)

Sam browne stud & screw

| Art. No. | Article name | Unit | Price |
|--------------|-----------------------------------|-------------------|---------------------|
| T24213057M11 | 10 x 7 antique brass | p. pce 100 pcs | 1,26 netto 81,00 |
| T24213057M12 | 10 x 7 solid brass | p. pce 100 pcs | 1,09 netto 70,00 |
| T24213057M18 | 10 x 7 solid brass, nickel plated | p. pce 100 pcs | 0,96 netto 62,00 |
| T75200505M11 | 7 x 7 antique brass | p. pce 100 pcs | 1,43 netto 92,00 |
| T75202043M12 | 8 x 5 solid brass | p. pce 100 pcs | 0,81 netto 52,00 |
| T75202043M18 | 8 x 5 solid brass, nickel plated | p. pce 100 pcs | 0,67 netto 43,00 |

3870.

Bifurcated rivets

| | | |
|-------------|--------------|-------|
| 3 x 12K 5,5 | , 100 pcs | 12,50 |
| 3 x 14K 5,5 | , 100 pcs | 12,50 |
| 3 x 16K 5,5 | , 100 pcs | 12,50 |
| 3 x 17K 5,5 | , 100 pcs | 12,50 |
| 3 x 22K 5,5 | , 100 pcs EM | 20,73 |



Smaller quantities on demand!

| Art. No. | Article name | Unit | Price |
|------------|-----------------------------------|---------------------------------|-------|
| 3900.Ö5 | Sail eyelet, brass, nickel-plated | .100 pcs, 5 mm (eyelets) | 8,10 |
| 3900.R5 | | .100 pcs, 5 mm (rings) | 6,00 |
| 3900.Ö5 | | .500 pcs, 5 mm (eyelets) | 27,00 |
| 3900.R5 | | .500 pcs, 5 mm (rings) | 20,00 |
| 3900.Ö+R8 | | .100 pcs, 8 mm (eyelets+rings) | 18,00 |
| 3900.Ö+R8 | | .500 pcs, 8 mm (eyelets+rings) | 45,00 |
| 3900.Ö+R10 | | .100 pcs, 10 mm (eyelets+rings) | 25,92 |
| 3900.Ö+R10 | | .500 pcs, 10 mm (eyelets+rings) | 64,80 |
| 3900.Ö+R10 | Sail eyelets, polished brass | .100 pcs, 10 mm (eyelets+rings) | 19,60 |
| 3900.Ö+R10 | | .100 pcs, 10 mm (eyelets+rings) | 49,00 |
| 3900.Ö14 | | .100 pcs, 14 mm (eyelets) | 13,40 |
| 3900.R14 | | .100 pcs, 14 mm (rings) | 9,41 |
| 3900.Ö14 | | .500 pcs, 14 mm (eyelets) | 65,40 |
| 3900.R14 | | .500 pcs, 14 mm (rings) | 43,60 |

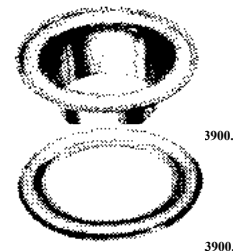

| Art. No. | Article name | Prices ex VAT. (€) |
|---|---|--------------------|
| 291 Riveting tools & machinery | | |
| 3954 | Combination-tool, for 4 mm Rivets | 5,16 |
| 3950.3 | Shaft-setter, 3 mm | 6,61 |
| 3950.4 | dto., 4 mm | 6,62 |
| 3950.5 | dto., 5 mm | 10,30 |
| 3950.6 | dto., 6 mm | 10,52 |
| 3951.3 | Head-setter, 3 mm | 6,61 |
| 3951.4 | dto., 4 mm | 10,08 |
| 3951.5 | dto., 5 mm | 11,08 |
| 3951.6 | dto., 6 mm | 12,66 |
| 3963.06 | Hollow rivet setter, up to 6 mm | 10,08 |
| 3963.07 | dto. 7 mm | 10,08 |
| 3963.08 | dto. 9 mm | 10,08 |
| 3963.09 | dto. 9 mm | 10,80 |
| 3963.10 | dto. 10 mm | 10,08 |
| 3963.12 | dto. 12 mm | 10,08 |
| 3963.13 | dto. 13 mm | 10,08 |
| 3963.15 | dto. 15 mm | 10,08 |
| 19.2.0400 – 0401 | Eyelet-punch „Shark“, 300 mm For eyelets from 6,5 to 12,5 mm Eyelet-punch „Shark“ without tools | 46,48 |
| Tools for No. 19-2-0400-401 | | |
| 19.2.0400 – 1406 | tool 6,5 mm | 3,26 |
| 19.2.0400 – 1408 | tool 8,5 mm | 3,26 |
| 19.2.0400 – 1410 | tool 10,0 mm | 9,50 |
| 19.2.0400 – 1412 | tool 12,5 mm | 11,14 |
| Eyelets & rings for No. 19.2.0400-0401 | | |
| Brass, nickle-plated | | |
| 19.2.0400 – 3406 | 75 pcs 6,5 mm | 5,70 |
| 19.2.0400 – 3408 | 50 pcs 8,5 mm | 5,70 |
| 19.2.0400 – 3410 | 25 pcs 10,0 mm | 5,70 |
| 19.2.0400 – 3412 | 15 pcs 12,5 mm | 5,70 |
| 3965 | Forged eyelet-punch .a/3 mm, .b/4 mm, .c/5 mm tools | 32,62 |
| 3966 | Pressed-steel frame eyelet punch .a/3 mm, .b/4 mm, .c/5 mm tools | 11,60 |
| 3967 | tool-prices .a, .b or .c | 2,15 |
| 3964 | eyelet&holepunch pliers combination for eyelets 4,5, 5,0 & 5,5 mm | 13,00 |
| 3964. | Spare eyelets for No. 3964, iron,nickel-pl. 100 pcs | |
| | ÖA vern. 4,5 m | 3,58 |
| | ÖB vern. 5,0 m | 3,58 |
| | ÖC vern. 5,5 m | 3,58 |
| 3964. | spare eyelets for No. 3964, brass polished, 100 pcs | |
| | ÖA 4,5 m | 5,25 |
| | ÖB 5,0 m | 5,65 |
| | ÖC 5,5 m | 5,80 |



3954



0400-0401

19.2.

Art. No. Article name Prices ex VAT. (€)

291 Riveting tools & machinery (cont.)

| | | |
|-------------|--|--------|
| | Eyelet-setter for sail eyelets & rings | |
| 4004 | .05 mm | 61,20 |
| 4004 | .08 mm | 39,56 |
| 4004 | .10 mm | 41,30 |
| 4004 | .12 mm | 40,77 |
| 4004 | .14 mm | 51,16 |
| 4004 | .16 mm | 50,96 |
| 4004 | .20 mm | 58,58 |
| 4004 | .25 mm | 66,98 |
| 4004 | .32 mm | 89,60 |
| 4004 | .36 mm | 99,68 |
| 4004 | .40 mm | 109,76 |



Different sizes on demand!

| | | |
|------------------------|---|-------|
| 230SET | Tool only for No. 230 , 15 mm | 28,60 |
| | Spare snaps, 15 mm Head-diam. Length of shaft ca. 6,5 mm | |
| 230-S.025 MB | 25 pcs, polished brass | 16,36 |
| 230-S.100 MB | 100 pcs, polished brass | 35,00 |
| 230-S.025 MN | 25 pcs, brass, nickle-pl. | 16,36 |
| 230-S.100 MN | 100 pcs, brass, nickle-pl. | 42,00 |
| 230-S.025 MA | 25 pcs, brass, anthrazite | 16,36 |
| 230-S.100 MA | 100 pcs, brass, anthrazite | 35,90 |
| 230-S.100 MS | 100 pcs, brass black | 31,98 |
| 230-S.025 EA | 25 pcs, aged iron | 13,35 |
| 230-S.100 EA | 100 pcs, aged iron | 28,00 |
| 230-S.025 ES | 25 pcs, iron, black | 11,40 |
| 230-S.100 ES | 100 pcs, iron, black | 22,68 |
| | Spare snaps, 15 mm Head-diam. extra long shafts (ca. 9,5 mm) | |
| 230-S.025 MN XL | 25 pcs, brass, nickle-pl. | 22,00 |
| 230-S.100 MN XL | 100 pcs, brass, nickle-pl. | 52,32 |
| 230-13SET | Tool only for No. 230-13 , 13 mm | 28,00 |
| | Spare snaps, 13 mm Head-diam. | |
| 230.13-S.025 MB | 100 pcs, polished brass | 9,45 |
| 230.13-S.100 MB | 100 pcs, polished brass | 25,17 |
| 230.13-S.025 MN | 100 pcs, brass, nickle-pl. | 9,51 |
| 230.13-S.100 MN | 100 pcs, brass, nickle-pl. | 25,38 |
| 230.13-S.025 MA | 100 pcs, brass anthrazite | 10,23 |
| 230.13-S.100 MA | 100 pcs, brass anthrazite | 35,43 |

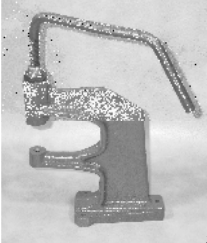
| Art. No. | Article name | Prices ex VAT. (€) | |
|--|--|--------------------|---|
| 291 Riveting tools & machinery(cont.) | | | |
| W-1 | Lever-press „Osborne“ Incl. cutting board, tools & Pressure plate | 156,00 |  |
| 3992 | Spindel-lever machine without tools ca. 3,9 kg, height 33,5 cm | 213,75 |  |
| 3991. | Hole punch pipes for No. 3992 (M6 screw) | | |
| | 1,5 mm | 7,67 | |
| | 2,0 mm | 7,67 | |
| | 3,0 mm | 7,67 | |
| | 3,5 mm | 7,67 | |
| | 4,0 mm | 7,67 | |
| | 4,5 mm | 7,67 | |
| | 5,0 mm | 7,67 | |
| | 6,0 mm | 7,67 | |
| | 7,0 mm | 8,95 | |
| | 8,0 mm | 10,23 | |
| | 9,0 mm | 10,23 | |
| | 10,0 mm | 11,50 | |

**Tools above are nearly sold out, so special sale prices!!
Regular tools for No.3992 are more expensive (on demand only!)**

| Art. No. | Article name | Prices ex VAT. (€) |
|-------------------------------|--|-------------------------|
| 310 Threads & yarn | | |
| | Pitched threads&plastic needle, ca. 1,50 m long | |
| 4110.1.50 | yellow, 50 pcs. | netto 19,22 |
| 4110.2.50 | black, 50 pcs. | netto 19,22 |
| 4110.1.10 | yellow, 10 pcs. | netto 5,11 |
| 4110.2.10 | black , 10 pcs. | netto 5,11 |
| | Hemp-yarn | |
| 4115 | .1100 quadruple, 1100g | netto 26,50 |
| 4115 | .1500 quadruple, 1500g | netto 35,84 |
| | Nylon.thread, reverse twist for Hand-sewing | Prices per Spule |
| 4112.1 | 11/2 white, 250 g | netto 15,60 |
| 4112.191 | 11/2 dark brown, 250 g | netto 18,15 |
| 4112.2 | 11/2 dark brown, 250 g | netto 18,15 |
| 4112.3 | 11/2 black, 250 g | netto 18,15 |
| 4116.1 imp | 11/6 white, 250g | netto 15,60 |
| 4116.2 imp | 11/6 brown, 250g | netto 18,15 |
| 4116.3 imp | 11/6 black, 250g | netto 18,15 |
| | Cushion pull up yarn "Spitzenreiter", Spool ca. 400 g | Price per kg |
| 4117.6.1 | white, .6 Polyesteryarn | 53,92 |
| 4117.8.1 | white, .8 dto. | 53,92 |
| 4117.10.1 | white, .10 dto. | 53,92 |
| 4117.12.1 | white, .12 dto. | 53,92 |
| 4117.14.1 | white, .14 dto. | 53,92 |
| 4117.14.3 | black, .14 dto. | 65,15 |
| 4117.16.1 | white, .16 dto. | 53,92 |
| 4117.16.3 | black, .16 dto. | 65,15 |
| | "Coats" former „Hoogen“ Linen twine | Price perSpule |
| | "Blauschild"-quality , 250 g | |
| 4183.1 | 18/3 white | netto 30,33 |
| 4183.2 | dto. -dark brown | netto 33,65 |
| 4183.3 | dto. - black | netto 33,65 |
| 4183.4 | dto. - yellow | netto 33,65 |
| 4183.107 | dto. - medium brown | netto 33,65 |
| 4184.1 | 18/4 - white | netto 30,33 |
| 4184.2 | dto. - dark brown | netto 33,65 |
| 4184.3 | dto. - black | netto 33,65 |
| 4184.4 | dto. - yellow | netto 33,65 |
| 4185.1 | 18/5 - white | netto 30,33 |
| 4185.2 | dto. - dark brown | netto 33,65 |
| 4185.3 | dto. - black | netto 33,65 |
| 4186.1 | 18/6 - white | netto 30,33 |
| 4186.2 | dto. - dark brown | netto 33,65 |
| 4186.3 | dto. - black | netto 33,65 |
| 4186.4 | dto. - yellow | netto 33,65 |
| 4253.1 | 25/3 -white | netto 30,75 |
| 4253.2 | dto. - dark brown | netto 33,78 |
| 4253.3 | dto. - black | netto 33,78 |
| 4253.4 | dto. - yellow | netto 33,78 |

Thread listed above, come as single spools. If You order a box of one type, You`ll receive 5% discount!.
All threads & yarns of "Coats" programme are available!

| Art. No. | Article name | | | Prices ex VAT. (€) |
|--------------------------------------|--|-------------------|-------|--------------------|
| 310 Threads & yarn(cont.) | | | | |
| | "Coats" former „Hoogen“ Handsewing double twine | | | |
| | à 100 g, reverse-twist (pitched) | | | |
| 4006. | .198 imp.white, 20/6 | p.pce | netto | 19,44 |
| 4008. | .198 imp. white, 20/8 | p.pce | netto | 19,44 |
| 4006. | .136 glanz black, 20/6 | p.pce | netto | 20,91 |
| 4008. | .136 glanz black, 20/8 | p.pce | netto | 20,91 |
| 4006. | .106 glanz brown, 20/6 | p.pce | netto | 20,91 |
| 4008. | .106 glanz brown, 20/8 | p.pce | netto | 20,91 |
| | "Coats" former „Hoogen“ Linen-card-twine | | | |
| | à 15 m 18/3, | | | |
| 4151 | white , | p.pce | netto | 2,93 |
| 4152 | dark brown, | p.pce | netto | 2,93 |
| 4153 | black , | p.pce | netto | 2,93 |
| 4151.2 | white , | from 35 pcs / pce | netto | 1,30 |
| 4152.2 | dark brown, | from 35 pcs / pce | netto | 1,30 |
| 4153.2 | black , | from 35 pcs / pce | netto | 1,30 |
| | „Polycord“ is now branded „Terko Satin“. | | | |
| | „Coats“ Terko Satin former Polycord | | | |
| 4214.9700. | 2500 m 25 black (20/3) | Spool | netto | 26,98 |
| 4214.H7791. | 2500 m 25 brown (20/3) | Spool | netto | 26,98 |
| 4214.NATRL. | 2500 m 25 white (20/3) | Spool | netto | 24,36 |
| 4203.9700. | 1250 m 16/3 black (15/3) | Spool | netto | 24,27 |
| 4203.H7791. | 1250 m 16/3 brown (15/3) | Spool | netto | 24,27 |
| 4203.NATRL. | 1250 m 16/3 white (15/3) | Spool | netto | 21,90 |
| 4204.9700. | 1000 m 16/4 black (15/4) | Spool | netto | 25,89 |
| 4204.H7791. | 1000 m 16/4 brown (15/4) | Spool | netto | 25,89 |
| 4204.NATRL. | 1000 m 16/4 white (15/4) | Spool | netto | 23,36 |

Thread listed above, come as single spools. If You order a box of one type, You`ll receive 5% discount!.
All threads & yarns of “Coats” programme are available!

| Art. No. | Article name | Prices ex VAT. (€) |
|------------------------|---|------------------------|
| 310 | Threads & yarn(cont.) | |
| | "Coats" former „Hoogen“ Troutyarn braided, impregnated or dull. (New: it chaged from kg of meter) | |
| | Thickness no. 5 (0,6 mm) | price per 1000 m spool |
| 4405.1 imp/dull | Farbe: rohweiß | netto 32,76 / 30,98 |
| 4405.2 imp/dull | Farbe: dunkelbraun | netto 36,74 / 35,71 |
| 4405.3 imp/dull | Farbe: schwarz | netto 36,71 / 35,71 |
| | Thickness no. 6 (0,8 mm) | price per 700 m spool |
| 4406.1 imp/dull | Farbe: rohweiß | netto 32,94 / 29,94 |
| 4406.2 imp/dull | Farbe: dunkelbraun | netto 37,18 / 34,81 |
| 4406.3 imp/dull | Farbe: schwarz | netto 37,18 / 34,81 |
| | Thickness no. 7 (1,0 mm) | price per 500 m spool |
| 4407.1 imp/dull | Farbe: rohweiß | netto 28,99 / 27,57 |
| 4407.2 imp/dull | Farbe: dunkelbraun | netto 33,00 / 32,26 |
| 4407.3 imp/dull | Farbe: schwarz | netto 33,00 / 32,26 |
| | Thickness no. 8 (1,1 mm) | price per 500 m spool |
| 4408.1 imp/dull | Farbe: rohweiß | netto 34,93 / |
| 4408.2 imp/dull | Farbe: dunkelbraun | netto 39,91 / 36,15 |
| 4408.3 imp/dull | Farbe: schwarz | netto 39,91 / 36,15 |
| | Thickness no. 10 (1,3 mm) | price per 350 m spool |
| 4410.1 imp/dull | Farbe: rohweiß | netto 27,85 / |
| 4410.2 imp/dull | Farbe: dunkelbraun | netto 32,28 / |
| 4410.3 imp/dull | Farbe: schwarz | netto 32,28 / 30,28 |
| | Thickness no. 12 (1,4 mm) | price per 350 m spool |
| 4412.1 imp/dull | Farbe: rohweiß | netto 31,78 / 29,51 |
| 4412.2 imp/dull | Farbe: dunkelbraun | netto 37,11 / 35,94 |
| 4412.3 imp/dull | Farbe: schwarz | netto 37,11 / 35,94 |
| | "Coats" former „Hoogen“ Troutyarn braided, impregnated or dull. | |
| 440..lose | Troutyarn loose Please give colour & size. | per mtr. 0,50 |
| | Linen cable-twine | price per 250g spool |
| Ho1100.183 0198 | 18/3 white | netto 23,41 |
| Ho1100.186 0101 | 18/6 brown | netto 30,91 |
| Ho1100.186 0136 | 18/6 black | netto 30,89 |
| Ho1100.186 0198 | 18/6 white | netto 28,78 |
| Ho1100.188 0198 | 18/8 white | netto 30,89 |

Thread listed above, come as single spools. If You order a box of one type, You'll receive 5% discount!.
All threads & yarns of "Coats" programme are available!

Art. N0. Article name Prices ex VAT. (€)

310 Threads 6 yarn (cont.)

„Meisterklasse“ is now branded „Gral“.

Last orders of „Meisterklasse“ will be delivered on demand if still in stock.

| Polyesterthread | | price per spool | |
|-----------------------------|--------------------|-----------------|-------|
| Gral 10 (former 11/3) | | | |
| 4451.U2703 | .1000 m white | netto | 20,54 |
| 4451.U1702 | .1000 m true white | netto | 23,87 |
| 4451.U9091 | .1000 m brown | netto | 23,87 |
| 4451.U9500 | .1000 m black | netto | 23,87 |
| | | | |
| Gral 15 (former 15/3) | | | |
| 4453.U2703 | .1000 m white | netto | 17,96 |
| 4453.U1702 | .1000 m true white | netto | 20,12 |
| 4453.U9091 | .1000 m brown | netto | 20,12 |
| 4453.U9500 | .1000 m black | netto | 20,12 |
| Ask for 1.500 meter spools. | | | |
| | | | |
| Gral 18 (former 18/3) | | | |
| 4458.U2703 | .1500 m white | netto | 21,97 |
| 4458.U1702 | .1500 m true white | netto | 24,93 |
| 4458.U9091 | .1500 m dark brown | netto | 24,93 |
| 4458.U9500 | .1500 m black | netto | 24,93 |
| | | | |
| Gral 20 (former 20/3) | | | |
| 4461.U2703 | .2000 m white | netto | 24,92 |
| 4461.U1702 | .2000 m true white | netto | 28,24 |
| 4461.U9091 | .2000 m brown | netto | 28,24 |
| 4461.U9500 | .2000 m black | netto | 28,24 |
| | | | |
| Gral 20 (former 20/3) | | | |
| 4461.U2703 | .600 m white | netto | 7,87 |
| 4461.U1702 | .600 m true white | netto | 8,89 |
| 4461.U9091 | .600 m brown | netto | 8,89 |
| 4461.U8917 | .600 m dark brown | netto | 8,89 |
| 4461.U8177 | .600 m beige | netto | 8,89 |
| 4461.U1280 | .600 m yellow | netto | 8,89 |
| 4461.U9500 | .600 m black | netto | 8,89 |
| 4461.U7895 | .600 m darkblue | netto | 8,89 |
| 4461.U7443 | .600 m blue | netto | 8,89 |
| 4461.U2547 | .600 m orange | netto | 8,89 |
| 4461.U4079 | .600 m red | netto | 8,89 |
| 4461.U5001 | .600 m green | netto | 8,89 |
| 4461.U9129 | .600 m grey | netto | 8,89 |
| 4461.U9715 | .600 m grau | netto | 8,89 |

Other colours on demand, please ask for Colour panel!

Thread listed above, come as single spools. If You order a box of one type, You'll receive 5% discount!.
All threads & yarns of "Coats" programme are available!

| Art. No. | Article name | Prices ex VAT. (€) |
|---------------------------------------|--|--------------------|
| 310 Threads & yarn (cont.) | | |
| | Polyesterthreads (cont.) | Price per spool |
| | „Coats“ Gral 30 (former 30/3), 3000 m spools | |
| 4471.U2703 | .3000 m white | netto 24,07 |
| 4471.U1702 | .3000 m truewhite | netto 27,57 |
| 4471.U9091 | .3000 m brown | netto 27,57 |
| 4471.U9500 | .3000 m black | netto 27,57 |
| | „Coats“ Gral 30 (former 30/3), 1000 m spools | |
| 4471.U2703 | .1000 m white | netto 8,46 |
| 4471.U1702 | .1000 m true white | netto 9,65 |
| 4471.U9091 | .1000 m dark brown | netto 9,65 |
| 4471.U8917 | .1000 m medium brown | netto 9,65 |
| 4471.U8177 | .1000 m beige | netto 9,65 |
| 4471.U1280 | .1000 m yellow | netto 9,65 |
| 4471.U9500 | .1000 m black | netto 9,65 |
| 4471.U7895 | .1000 m dark blue | netto 9,65 |
| 4471.U7443 | .1000 m blue | netto 9,65 |
| 4471.U2547 | .1000 m orange | netto 9,65 |
| 4471.U4079 | .1000 m red | netto 9,65 |
| 4471.U5001 | .1000 m green | netto 9,65 |
| 4471.U9129 | .1000 m grey | netto 9,65 |
| 4471.U9715 | .1000 m grey | netto 9,65 |
| | „Coats“ Gral 30 (former 30/3), 2000 m spools | |
| 4471.U1702 | .2000 m true white | netto 17,76 |
| 4471.U9091 | .2000 m dark brown | netto 17,76 |
| 4471.U9500 | .2000 m black | netto 17,76 |
| 4481.U7443 | .2000 m blue | netto 17,76 |
| | „Coats“ Gral 40 (former 40/3), 1000 m spools | |
| 4481.U2703 | .1000 m white | netto 7,22 |
| 4481.U1702 | .1000 m true white | netto 8,17 |
| 4481.U9091 | .1000 m dark brown | netto 8,17 |
| 4481.U8917 | .1000 m medium brown | netto 8,17 |
| 4481.U8177 | .1000 m beige | netto 8,17 |
| 4481.U1280 | .1000 m yellow | netto 8,17 |
| 4481.U9500 | .1000 m black | netto 8,17 |
| 4481.U7895 | .1000 m dark blue | netto 8,17 |
| 4481.U7443 | .1000 m blue | netto 8,17 |
| 4481.U2547 | .1000 m orange | netto 8,17 |
| 4481.U4079 | .1000 m red | netto 8,17 |
| 4481.U5001 | .1000 m green | netto 8,17 |
| 4481.U9129 | .1000 m grey | netto 8,17 |
| 4481.U9715 | .1000 m grey | netto 8,17 |

Different colours available, please ask for our colour panel.

LF 3610-00 **Transparent artificial sinew**, 3 mm wide and ca. 270 m long 31,00

Thread listed above, come as single spools. If You order a box of one type, You'll receive 5% discount!.
All threads & yarns of “Coats” programme are available!

Of course we will supply you with „Amman“brand articles on demand!

| Art. No. | Article name | Prices <i>inkl.</i> VAT. (€) | |
|---|--|------------------------------|-----------------------------------|
| 320 Books on Leather & Saddlery (mostly in German!!) | | | |
| 5202 | Vollständiges Handbuch für Sattler, Täschner und Rieme (Reprint Schlüter/Rausch v. 1897) | netto | *35,28 (temporarily out of stock) |
| 5205 | Vollständiges Handbuch für Wagenfabrikanten (Reprint Schlüter/Rausch v. 1891) | netto | *35,28 (temporarily out of stock) |
| 5210 | Musterzeichnungen für Sattler, Rieme, Täschner und Wagenbauer (Reprint Londner/Pariser v. 1846) | netto | *38,35 (temporarily out of stock) |
| 5215 | Leder gestalten und verarbeiten Verfasser: Robert Friedrich <u>(out of order!)</u> out of order | netto | *34,77 |
| 5216 | Ornamente punzieren und schneiden Verfasser: Georg Stahl | netto | * 8,69 |
| 5220 | Gerben 2.Auflage Verfasser: H. Ottiger / U. Reeb | netto | *19,90 |
| 5225 | Sattler / Sattlerin Erläuterungen und Praxishilfen zur Ausbildungsverordnung | netto | *16,36 (temporarily out of stock) |
| LF605900 | The Art of Handsewing Leather Verfasser: Al Stolman | netto | *21,30 |
| | Encyclopedia Saddle Making Verfasser: Al Stolman | | |
| TWI0194001 | Vol.1 | netto | *85,04 |
| TWI0194002 | Vol.2 | netto | *85,04 |
| TWI0194003 | Vol.3 | netto | *85,04 |
| 9121 | Handbuch für Lederarbeiten Verfasser: Valerie Michael | netto | *38,90 (temporarily out of stock) |

*All books include 7% VAT!!!

| Art. No. | Article name | Prices ex VAT. (€) |
|----------|--------------|--------------------|
|----------|--------------|--------------------|

330 Zips, webbing, tapes, leathers and upholstery materials (Neopren, felt etc.)

| | | | |
|------|---|-------------------------------------|--------|
| | Zips "YKK", open end, plasticspiral, <u>not</u> partable! | | |
| 4429 | .CF3.00 | 24 mm tape, 3 mm bsirale per 100 m | 94,46 |
| 4429 | .CF3.00 | 24 mm tape, 3 mm spirale per meter | 1,18 |
| 4429 | .CF5.00 | 32 mm tape, 5 mm spirale per 100m | 187,31 |
| 4429 | .CF5.00 | 32 mm tape, 5 mm spirale per meter | 2,60 |
| 4429 | .CF8.00 | 32 mm tape, 8 mm spirale per 100m | 272,76 |
| 4429 | .CF8.00 | 32 mm tape, 8 mm spirale per meter | 3,41 |
| 4429 | .CF10.00 | 40 mm tape, 10 mm spirale per 100 m | 289,86 |
| 4429 | .CF10.00 | 40 mm tape, 10 mm spirale per meter | 4,14 |

Other colours available.

Please order zippers, top- and buttonstops extra!

| | | | |
|----------|--------------------------------------|---------|-------|
| 4429.S3 | Zipper , 3 mm spirale, black | per 100 | 14,25 |
| 4429.S5 | Zipper , 5 mm spirale, black | per 100 | 20,23 |
| 4429.S8 | Zipper , 8 mm spirale, black | per 100 | 51,45 |
| 4429.S10 | Zipper , 10 mm spirale, black | per 100 | 61,35 |

Metal zips "YKK", 8 mm, not partable !
black, 32 mm tape

| | | | |
|--------|------------|------------------------|-------|
| 4430.8 | .00 endlos | per meter | 8,54 |
| 4430.8 | .00 endlos | from 100 m / per meter | 6,83 |
| 4430.8 | .TS | topstops per 100 | 10,50 |
| 4430.8 | .BS | buttontops per 100 | 8,64 |
| 4430.8 | .S | 8 mm rail per 100 | 73,28 |

Length to Your order.

Metal zips "YKK" , , **8 mm** partable,
Black, ca. 18 mm per tape side

| | | | |
|--------|-----|---------|------|
| 4430.8 | .20 | cm long | 2,87 |
| 4430.8 | .30 | cm long | 5,40 |
| 4430.8 | .36 | cm long | 5,66 |
| 4430.8 | .40 | cm long | 6,21 |
| 4430.8 | .44 | cm long | 6,29 |
| 4430.8 | .46 | cm long | 6,70 |
| 4430.8 | .48 | cm long | 6,60 |
| 4430.8 | .60 | cm long | 6,27 |
| 4430.8 | .70 | cm long | 6,92 |
| 4430.8 | .75 | cm long | 8,71 |
| 4430.8 | .80 | cm long | 7,58 |
| 4430.8 | .92 | cm long | 7,83 |

Zip "YKK", Vislon plastic, **5 mm** toothed,partable
Black, ca 17 mm per tape side

| | | | |
|--------|-----|---------|------|
| 4431.5 | .36 | cm long | 2,46 |
| 4431.5 | .40 | cm long | 2,68 |
| 4431.5 | .46 | cm long | 3,00 |
| 4431.5 | .50 | cm long | 2,86 |
| 4431.5 | .70 | cm long | 3,18 |
| 4431.5 | .90 | cm long | 3,90 |

Length to Your order from 10 pcs.!

| Art. No. | Article name | Prices ex VAT. (€) |
|------------|---|--------------------|
| 330 | Zips, webbing, tapes, leathers and upholstery materials (Neopren, felt etc.) (cont.) | |

| | | |
|--------|---|------|
| | Zips "YKK", Vislon plastic, 8 mm toothed, partable Black, ca. 17 mm per tape side | |
| 4431.8 | .36 cm long | 4,01 |
| 4431.8 | .38 cm long | 4,08 |
| 4431.8 | .40 cm long | 4,31 |
| 4431.8 | .42 cm long | 4,21 |
| 4431.8 | .44 cm long | 4,27 |
| 4431.8 | .45 cm long | 4,31 |
| 4431.8 | .46 cm long | 4,51 |
| 4431.8 | .47cm long | 4,55 |
| 4431.8 | .48 cm long | 4,58 |
| 4431.8 | .50 cm long | 4,65 |
| 4431.8 | .60 cm long | 4,99 |
| 4431.8 | .68 cm long | 5,06 |
| 4431.8 | .70 cm long | 5,13 |
| 4431.8 | .72 cm long | 5,19 |
| 4431.8 | .74 cm long | 5,26 |
| 4431.8 | .80 cm long | 5,45 |
| 4431.8 | .90 cm long | 5,61 |

| | | |
|--------|---|------|
| | Plastic zip "YKK", plastic-spiral, partable 5 mm rail | |
| 4553.5 | . 30 cm long | 1,60 |
| 4553.5 | . 36 cm long | 1,90 |
| 4553.5 | . 38 cm long | 2,19 |
| 4553.5 | . 40 cm long | 2,16 |
| 4553.5 | . 42 cm long | 2,19 |
| 4553.5 | . 44 cm long | 2,09 |
| 4553.5 | . 46 cm long | 2,24 |
| 4553.5 | . 48 cm long | 2,29 |
| 4553.5 | . 50 cm long | 2,29 |
| 4553.5 | . 70 cm long | 2,57 |
| 4553.5 | . 76 cm long | 2,97 |
| 4553.5 | . 80 cm long | 2,91 |
| 4553.5 | . 90 cm long | 3,01 |

| | | |
|--------|---|------|
| | Plastic zip "YKK", plastic-spiral, partable 8 mm rail | |
| 4553.8 | . 34 cm long | 2,58 |
| 4553.8 | . 36 cm long | 2,64 |
| 4553.8 | . 38 cm long | 2,92 |
| 4553.8 | . 40 cm long | 3,10 |
| 4553.8 | . 42 cm long | 3,17 |
| 4553.8 | . 44 cm long | 3,24 |
| 4553.8 | . 46 cm long | 3,17 |
| 4553.8 | . 48 cm long | 3,14 |
| 4553.8 | . 50 cm long | 3,29 |

| | | |
|----------------|--|------|
| | Plastic zip "OPTI", plastic-spiral, partable 8 mm rail | |
| 4553.8.45 OPTI | 45 cm long | 3,27 |
| 4553.8.48 OPTI | 48 cm long | 3,55 |
| 4553.8.60 OPTI | 60 cm long | 3,51 |
| 4553.8.70 OPTI | 70 cm long | 3,68 |
| 4553.8.75 OPTI | 75 cm long | 3,76 |

Length to Your order from 10 pcs.

| | | |
|--------|---------------------------------------|------|
| 12.3 . | 0,6 x 50 Doublesided carpet-duct-tape | 5,41 |
| 12.3 . | 0,9 x 50 Doublesided carpet-duct-tape | 7,16 |

| Art. No. | Article name | Prices ex VAT. (€) | |
|------------|---|--------------------|--|
| 330 | Zips, webbing, tapes, leathers and upholstery materials (Neopren, felt etc.) | (cont.) | |

Hook & loop tape

| | | | |
|-----------|-------------------|-----------|-------|
| 5420.K | Hook-tape, 20 mm | per Meter | 1,06 |
| 5420.F | Loop-tape, 20 mm | per Meter | 1,06 |
| 5420.K.25 | Hook-tape, 20 mm | 25 m roll | 11,25 |
| 5420.F.25 | Loop-tape, 20 mm | 25 m roll | 11,25 |
| 5430.K | Hook-tape, 30 mm | per meter | 1,75 |
| 5430.F | Loop-tape, 30 mm | per meter | 1,75 |
| 5430.K.25 | Hook-tape, 30 mm | 25 m roll | 18,75 |
| 5430.F.25 | Loop-tape, 30 mm | 25 m roll | 18,75 |
| 5450.K | Hook-tape 50 mm | per meter | 2,72 |
| 5450.F | Loop-tape, 50 mm | per meter | 2,72 |
| 5450.K.25 | Hook-tape, 50 mm | 25 m roll | 29,10 |
| 5450.F.25 | Loop-tape, 50 mm | 25 m roll | 29,10 |
| 5499.K.25 | Hook-tape,100 mm | per meter | 5,70 |
| 5499.F.25 | Loop-tape, 100 mm | per meter | 5,70 |
| 5499.K.25 | Hook-tape,100 mm | 25 m roll | 61,05 |
| 5499.F.25 | Loop-tape, 100 mm | 25 m roll | 61,05 |

**Standard issued colours are: black, brown ,white, beige.
Further colours on demand.**

| | | | |
|----------|---|-----------|-------|
| 5425.KF | Hook & loop tape, 25 mm “back to back“ | per Meter | 2,80 |
| 5425.F25 | Loop-tape, 25 mm , self-adhesive | 25m roll | 28,17 |
| 5425.K25 | Loop-tape, 25 mm , self-adhesive | 25m roll | 28,17 |
| 5425.Fe | Loop-tape, elastic , 25 mm | per meter | 2,46 |
| 5438.Fe | Loop-tape, elastic , 38 mm | per meter | 3,36 |

Webbing & tape

| | | | |
|--------------------------------------|----------------------|-----------|--------|
| 5500 | Furniture web, 70 mm | per meter | 1,07 |
| Binding | | | |
| 5501.25.3 | 25mm black | 100 meter | 72,30 |
| 5501.30.3 | 30mm black | 100 meter | 81,60 |
| 5501.35.3 | 35mm black | 100 meter | 79,20 |
| 5501.40.3 | 40mm black | 100 meter | 92,70 |
| 5501.40.2 | 40mm brown | 100 meter | 92,70 |
| 5501.30.4 | 30mm yellow | 100 meter | 76,50 |
| 5501.30.5 | 30mm red | 100 meter | 76,50 |
| 5501.30.6 | 30mm blue | 100 meter | 76,50 |
| 5501.40.6 | 40mm blue | 100 meter | 92,70 |
| 5501.40.7 | 40mm bordeaux | 100 meter | 92,70 |
| Car seat belt webbing, black, | | | |
| 5549.020 | 20 mm | 100 meter | 51,60 |
| 5549.025 | 25 mm | 100 meter | 53,00 |
| 5549.030 | 30 mm | 100 meter | 62,50 |
| 5549.035 | 35 mm | 100 meter | 67,20 |
| 5549.040 | 40 mm | 100 meter | 96,10 |
| 5549.048 | 48 mm | 100 meter | 120,80 |
| 5549.080 | 80 mm | 100 meter | 142,20 |
| 5549.120 | 120 mm | 100 meter | 211,00 |

| Art. No. | Article name | Prices ex VAT. (€) |
|------------|---|--------------------|
| 330 | Zips, webbing, tapes, leathers and upholstery materials (Neopren, felt etc.) (cont.) | |

| | | |
|------|--|-------|
| | Polypropylene halter web, 20 mm, 50 m roll | |
| 5320 | .1PP white, roll | 21,50 |
| 5320 | .1PP weiß, per meter | 0,86 |
| 5320 | .2PP brown, rollr | 25,80 |
| 5320 | .2PP brown, per meter | 1,03 |
| 5320 | .3PP black, roll | 21,50 |
| 5320 | .3PP black, per meter | 0,86 |
| 5320 | .5PP red, roll | 25,80 |
| 5320 | .5PP red, per meter | 1,03 |

All webbing available per meter.

Nonelastic webbing

| | | |
|------|---|-------|
| | Polyami halter web (Nylon), 20mm, 50 m roll | |
| 5320 | .1 PA white, roll | 49,80 |
| 5320 | .1 PA white, per meter | 1,99 |
| 5320 | .2 PA brown, rolle | 49,80 |
| 5320 | .2 PA brown, per meter | 1,99 |
| 5320 | .3 PA black, roll | 49,80 |
| 5320 | .3 PA black, per meter | 1,99 |

| | | |
|------|---|-------|
| | Polypropylen halter web, 25 mm, 50 m roll | |
| 5325 | .1 PP white, roll | 26,00 |
| 5325 | .1 PP white, per meter | 1,04 |
| 5325 | .2 PP brown, roll | 31,20 |
| 5325 | .2 PP brown, per meter | 1,25 |
| 5325 | .3 PP black, roll | 26,00 |
| 5325 | .3 PP black, per meter | 1,04 |
| 5325 | .4 PP yellow, roll | 31,20 |
| 5325 | .4 PP yellow, per meter | 1,25 |
| 5325 | .5 PP red, roll | 31,20 |
| 5325 | .5 PP red, per meter | 1,25 |
| 5325 | .353 PP bordeaux, roll | 31,20 |
| 5325 | .353 PP bordeaux, per meter | 1,25 |
| 5325 | .6 PP blue, roll | 31,20 |
| 5325 | .6 PP blue, per meter | 1,25 |
| 5325 | .511 PP medium blue, roll | 31,20 |
| 5325 | .511 PP medium blue, per meter | 1,25 |
| 5325 | .563 PP navy blue, roll | 31,20 |
| 5325 | .563 PP navy blue, per meter | 1,25 |
| 5325 | .7 PP green, roll | 31,20 |
| 5325 | .7 PP green, per meter | 1,25 |
| 5325 | .741 PP silvery-grey, roll | 31,20 |
| 5325 | .741 PP silvery-grey, per meter | 1,25 |
| 5325 | .831 PP beige, roll | 31,20 |
| 5325 | .831 PP beige, per meter | 1,25 |
| 5325 | .832 PP nature, roll | 31,20 |
| 5325 | .832 PP nature, per meter | 1,25 |

| Art. No. | Article name | Prices ex VAT. (€) | |
|------------|---|--------------------|--|
| 330 | Zips, webbing, tapes, leathers and upholstery materials (Neopren, felt etc.) (cont.) | | |

Polyamid halter web (Nylon), 25mm, 50 m roll

| | | | |
|------|----------------|-----------|-------|
| 5325 | .3 PA black | roll | 68,90 |
| 5325 | .3 PA black | per meter | 2,76 |
| 5325 | .505 PA blue | oll | 65,60 |
| 5325 | .505 PA blue | per meter | 2,62 |
| 5325 | .607 PA green | roll | 65,60 |
| 5325 | .607 PA green | per meter | 2,62 |
| 5325 | .809 PA brown | roll | 65,60 |
| 5325 | .809 PA brown | per meter | 2,62 |
| 5325 | .309 PA red | roll | 65,60 |
| 5325 | .309 PA red | per meter | 2,62 |
| 5325 | .110 PA yellow | roll | 65,60 |
| 5325 | .110 PA yellow | per meter | 2,62 |
| 5325 | .801 PA beige | roll | 65,60 |
| 5325 | .801 PA beige | per meter | 2,62 |

Polypropylen halter web, 30 mm, 50 m roll

| | | | |
|------|-------------|-----------|-------|
| 5330 | .1PP white, | roll | 31,70 |
| 5330 | .1PP white | per meter | 1,27 |
| 5330 | .3PP black, | rolle | 31,70 |
| 5330 | .3PP black | per meter | 1,27 |

Polyamid halter web (Nylon), 30 mm , 50 m roll

| | | | |
|------|-------------|-----------|-------|
| 5330 | .3PA black, | roll | 79,80 |
| 5330 | .3PA black | per meter | 3,19 |

All webbing can be orderd from 1 meter..

Nonelastic web

Polypropylen halter web, 40 mm, 50 m roll

| | | | |
|------|-----------|-----------|-------|
| 5340 | .1 white, | roll | 48,70 |
| 5340 | .1 white | per meter | 1,95 |
| 5340 | .3 black | roll | 40,60 |
| 5340 | .3 black | per meter | 1,62 |

Polypropylene blanket web, 50 mm

| | | | |
|------|-----------|----------|-------|
| 5350 | .1 white | per 50 m | 51,50 |
| 5350 | .2 brown | per 50 m | 61,80 |
| 5350 | .3 black | per 50 m | 51,50 |
| 5350 | .4 yellow | per 50 m | 61,80 |
| 5350 | .5 red | per 50 m | 61,80 |
| 5350 | .6 blue | per 50 m | 61,80 |
| 5350 | .7 green | per 50 m | 61,80 |

| | | | |
|-----------------|-------------------------------|----------|-------|
| 16/01513 | Black web, 15 mm, lightweight | per 50 m | 33,40 |
|-----------------|-------------------------------|----------|-------|

Web, medium weight

| | | | |
|-----------------|------------------------|----------|--------|
| 16/03505 | 30 mm, black or brown | per 50 m | 69,70 |
| 16/03505 | 35 mm, black or brown | per 50 m | 78,00 |
| 16/04005 | 40 mm, black or brown | per 50 m | 78,00 |
| 16/05005 | 50 mm, black or brown | per 50 m | 90,50 |
| 16/08006 | 80 mm, black or brown | per 50 m | 113,20 |
| 16/10006 | 100 mm, black or brown | per 50 m | 113,40 |

Rein web,rippled, 16 mm (roll of 50 m)

| | | | |
|------|-----------|----------|-------|
| 5616 | .1 black | per roll | 37,50 |
| 5616 | .1A black | per m | 2,70 |
| 5616 | .2 brown | per roll | 37,50 |

Rein web, rippled, 20 mm (roll of 50 m)

| | | | |
|------|----------|----------|-------|
| 5620 | .1 black | per roll | 41,60 |
| 5620 | .2 brown | per roll | 41,60 |
| 5620 | .3 white | per roll | 41,60 |

| Art. No. | Article name | Prices ex VAT. (€) | |
|------------|---|--------------------|--|
| 330 | Zips, webbing, tapes, leathers and upholstery materials (Neopren, felt etc.) | (cont.) | |

| | | | |
|-------------|---|----------|-------|
| | Rein web, rippled, 24 mm (roll of 50 m) | | |
| 5624 | .1 black | per roll | 53,10 |
| 5624 | .2 brown | per roll | 53,10 |
| 5624 | .3 white | per roll | 53,10 |

| | | | |
|-------------|--|----------|-------|
| | Braided rein web, 24 mm (roll of 50 m) | | |
| 5724 | .1 black | per roll | 53,10 |
| 5724 | .2 brown | per roll | 53,10 |

| | | | |
|------------------|---|----------|-------|
| 16/024024 | Lunge web soft web, 24 mm red-yellow-red | per 50 m | 97,30 |
|------------------|---|----------|-------|

| | | | |
|-------------|----------------------------|-------|------|
| | Rubberised rein webt, 5/8" | | |
| 5816 | .1 black | per m | 5,84 |
| 5816 | .1 brown | per m | 7,28 |

| | | | |
|-------------|-------------|-------|------|
| 5816 | .1 HP black | per m | 3,60 |
| 5816 | .2 HP brown | per m | 3,60 |

| | | | |
|-------------|---------------------------|-------|------|
| | Rubberised rein web, 3/4" | | |
| 5820 | .1 HP black | per m | 3,01 |
| 5820 | .2 HP brown | per m | 2,44 |
| 5820 | .1 black | per m | 2,11 |

All webbing can be ordered from 1 meter!

Nonelastic webbing

| | | | |
|-------------|---------------------------|-------|------|
| | Rubberised rein web, 7/8" | | |
| 5822 | .1 black | per m | 7,36 |
| 5822 | .1 HP black | per m | 3,60 |
| 5822 | .2 brown | per m | 3,09 |
| 5822 | .2 HP brown | per m | 3,60 |

| | | | |
|----------------|--|-------|------|
| | Rein web " Super Grip" 3/4" (roll 15,24 m) | | |
| 5850.20 | .1 black | per m | 9,48 |
| 5850.20 | .2 brown | per m | 9,48 |

NEU

Biothane

| | | | |
|------------------|------------------------------------|-------------------|--------------------------|
| 5855.50.1 | Granite, schwarz, 50 mm, 30 m roll | per m per roll | 12,06 182,40 (6,08/m) |
|------------------|------------------------------------|-------------------|--------------------------|

| | | | |
|-------------------|---|-------|------|
| | Biothane Standard, 30,48 m roll 2,41 – 2,67 mm thick | | |
| 25.4.B10ST | 038BL520 black, 9 mm | per m | 3,16 |
| 25.4.B10ST | 012BL520 black, 13 mm | per m | 3,61 |
| 25.4.B10ST | 058BL520 black, 16 mm | per m | 4,84 |
| 25.4.B10ST | 034BL520 black, 19 mm | per m | 4,75 |
| 25.4.B10ST | 100BL520 black, 25 mm | per m | 5,36 |

| | | | |
|-------------------|-------------------------------|-------|------|
| 25.4.B10SH | 058OR522 orange, 16 mm | per m | 4,03 |
|-------------------|-------------------------------|-------|------|

Elastic Web

| | | | |
|-------------|---|-----------|--------|
| 5750 | .40 Rubber web (Saddle web), 38 mm | per m | 7,90 |
| 5750 | .38AL Rubber web (Saddle web), 38 mm | per 100 m | 328,00 |
| 5750 | .40AL Rubber web (Saddle web), 40 mm | per 100 m | 270,00 |

| | | | |
|-------------------|--------------|----------|--------|
| 15/03820.2 | 38 mm, brown | je 100 m | 223,20 |
| 15/03820.3 | 38 mm, black | je 100 m | 223,20 |

| Art. No. | Article name | Prices ex VAT. (€) | |
|------------|---|--------------------|--|
| 330 | Zips, webbing, tapes, leathers and upholstery materials (Neopren, felt etc.) | (cont.) | |

| | | | |
|---------------|--|-----------|--------|
| STR5258/30-20 | 30 mm, beige-white, | per 100 m | 243,92 |
| STR5258/45-20 | 45 mm, black or beige | per 100 m | 341,34 |
| 15/03820-F | 38 mm, blue-beige, caramel, black-silver | per 100 m | 232,00 |
| 15/03840 | 40 mm, black, | per 100 m | 274,00 |
| 15/05020 | 50 mm, black | per 100 m | 279,40 |
| 15/05020-F | 50 mm, black, silver stripes | per 100 m | 279,40 |
| 15/05020-WS | 50 mm, white, silver stripes | per 100 m | 270,00 |
| | -lightweight | | |
| 15/01806 | 18 mm, black | per 100 m | 96,20 |
| 15/02020 | 20 mm, black, brown or blue | per 100 m | 127,00 |
| 15/02520 | 25 mm, black & brown | per 100 m | 150,80 |
| 15/02501 | 25 mm, black/brown | per 100 m | 143,60 |
| 15/03020 | 30 mm, black | per 100 m | 181,00 |
| | -mediumweight | | |
| 15/02314 | 23 mm, black, tight elastic | per 100 m | 198,00 |
| 15/02511 | 25 mm, black, extra heavy | per 100 m | 341,20 |
| 15/02521 | 25 mm, black | per 100 m | 195,60 |
| 15/04001 | 40 mm, black/brown | per 100 m | 179,00 |
| 15/05001 | 50 mm, black or brown | per 100 m | 222,60 |
| 15/08001 | 80 mm, black or brown | per 100 m | 322,40 |
| 15/10001 | 100 mm, black or brown | per 100 m | 409,80 |

All webbing can be ordered from 1 meter!

Elastic web

| | | | |
|----------|--|-----------|--------|
| | -heavyweight | | |
| 15/02007 | 20 mm, black/brown | per 100 m | 143,60 |
| 15/02516 | 25 mm, black | per 100 m | 197,60 |
| 15/03007 | 30 mm, black | per 100 m | 222,62 |
| 15/04007 | 40 mm, black or brown | per 100 m | 280,80 |
| 15/05003 | 50 mm, black | per 100 m | 312,00 |
| 15/08003 | 80 mm, black or brown | per 100 m | 497,20 |
| 15/04217 | crosswise elastic web , 42 mm, schwarz, | per 100 m | 213,20 |
| 15/04504 | crosswise elastic web , 45 mm, schwarz, | per 100 m | 278,80 |

All webbing can be orderd from 1 meter!.

| | | | |
|----------|-------------|----------|-------|
| | Rubber rein | | |
| 5900.5/8 | black, | per pair | 5,72 |
| 5900.5/8 | brown, | per pair | 9,90 |
| 5900.1/2 | black, | per pair | 5,62 |
| 5900.1/2 | brown, | per pair | 5,62 |
| 5900.3/4 | brown, | per pair | 10,50 |
| 5900.7/8 | brown | per pair | 8,90 |

Sale off

| | | | |
|------------|---|----------|-------|
| | Rubber rein, A Sortiment black or brown | | |
| 5900-A 1/2 | 13 mm | per pair | 18,52 |
| 5900-A 5/8 | 16 mm | per pair | 19,74 |
| 5900-A 3/4 | 19 mm | per pair | 20,15 |
| 5900-A 7/8 | 22 mm | per pair | 20,30 |

| Art. No. | Article name | | Prices ex VAT. (€) |
|-------------------|---|-----------|-------------------------|
| 330 | Zips, webbing, tapes, leathers and upholstery materials (Neopren, felt etc.) (cont.) | | |
| | Leathers | | |
| | Latigoleather ½ skins (ca. 2 sqm) | | |
| 6099 | .1,5 – 2 | per sqm | 85,13 |
| 6099 | .2 – 2,5 | per sqm | 153,35 |
| 6100 | Latigo strings, ca. 12 mm, ca. 2,40 m long | per piece | 6,00 |
| | Leather piping, 3/16" | | |
| 6200 | .1 black, | per m | 4,84 |
| 6200 | .2 brown, | per m | 4,37 |
| 6200 | .4 havanna, | per m | 4,37 |
| 6201.5,5 | Plastic piping, diff. colours, with inlay | per m | 4,18 (147,00 per 100 m) |
| | without inlay | per m | 3,42 (121,00 per 100 m) |
| | Plasctic decoration piping, 2 mm | | |
| 6262 | .8 blue | per m | 1,52 |
| 6262 | .17 white | per m | 1,52 |
| | Plastic decoration piping, 3 mm | | |
| 6263 | .3 red | per m | 1,52 |
| 6263 | .8 blue | per m | 1,52 |
| 6263 | .17 white | per m | 1,52 |
| 21.1.50193 | tubular piping inlay,plasic | per 100 m | 169,00 |
| | from 200 m | per 100 m | 84,50 |
| 21.1.50072 | Nylonseil, 1,5 mm | per 100 m | 144,50 |
| | from 200 m | per 100 m | 72,25 |
| 6215.06 | PVC – rope, 6 mm | per m | 1,39 |
| | | per 100 m | 54,50 |
| 6215.08 | PVC – rope, 8 mm | per m | 2,19 |
| | | per 100 m | 79,50 |
| | Leder | | |
| | Lederthongs, 1 m x 1 mm, Goat | | |
| 6301 | black | per m | 1,07 |
| 6301E | black ,endless,from 50 m 1,12 per m else | per m | 1,69 |
| 6302 | brown | per m | 1,07 |
| 6302E | brown , endless,from 50 m 1,12 je m else | per m | 1,69 |
| 6303 | natural | per m | 0,97 |
| 6303E | natural , endless, from 50 m 1,12 je m else | per m | 1,69 |
| | Lederthongs, 1m x 1mm, Kangaroo | | |
| 6303E | natural | per m | 1,79 |
| 6303E | natural from 50 m roll | per m | 1,19 |
| | Lederthongs, 1 m x 2 mm | | |
| 6401 | black | per m | 0,86 |
| 6401E | black , endless(from 50 m 0,98 per m) | per m | 1,31 |
| 6402 | brown | per m | 0,82 |
| 6402E | brown , endless (from 50 m 0,98 per m) | per m | 1,31 |
| 6403 | natural | per m | 0,86 |
| 6403E | natural , endless (from 50 m 0,98 per m) | per m | 1,38 |
| 6404 | other colours | per m | 0,95 |
| 6417 | white | per m | 0,86 |
| | Other colours as endless cord on demand.. | | |
| | Square leatherthongs,, 2 x 2,5 mm, 1 m lang | | |
| 6450 | .1 black | | 1,10 |
| 6450 | .2 brown | | 0,92 |
| 6450 | .3 natural | | 0,92 |

| Art. No. | Article name | Prices ex VAT. (€) |
|------------|---|------------------------------------|
| 330 | Zips, webbing, tapes, leathers and upholstery materials (Neopren, felt etc.) (cont.) | |
| | Square leatherthongs, 2 x 2,5 mm, 2 m long | |
| 6452 | .1 black | 2,85 |
| 6452 | .2 brown | 2,85 |
| 6452 | .3 natural | 2,85 |
| | from 100 pcs. per 1 | 1,93 |
| | Leatherbraiding thongs, 2 mm | |
| 6502 | .1 natural per Meter | 1,63 |
| 6502 | .2 brown dto. | 1,63 |
| 6502 | .3 black dto. | 1,55 |
| 6502 | .4 cognac dto. | 1,55 |
| | from 50 m per Meter | 1,12 |
| | Leatherbraiding thongs, 3 mm | |
| 6503 | .1 natural per Meter | 2,09 |
| 6503 | .2 brown dto. | 2,09 |
| 6503 | .3 black dto. | 2,09 |
| 6503 | .4 cognac dto. | 2,09 |
| 6503 | .7 bordeauxy dto. | 1,66 |
| | from 50 m per Meter | 1,49 |
| | Leatherbraiding thong, 6 mm | |
| 6506 | .1 natural per Meter | 3,80 |
| 6506 | .2 brown per Meter | 3,80 |
| 6506 | .3 black per Meter | 3,80 |
| 6506 | .6 white per Meter | 3,80 |
| | from 50 m per Meter | 2,85 |
| | Leather straps, round | |
| 6603 | 3 mm, natural per Meter | 2,73 / per 100 m roll netto 137,00 |
| 6603.1 | 3 mm, black per Meter | 3,42 / per 100 m roll netto 171,00 |
| 6603.2 | 3 mm, brown per Meter | 3,54 / per 100 m roll netto 177,00 |
| 6605 | 5 mm, natural pro Meter | 2,97 / per 100 m roll netto 149,00 |
| 6605.1 | 5 mm, black pro Meter | 4,05 / per 100 m roll netto 202,50 |
| 6605.2 | 5 mm, brown pro Meter | 4,05 / per 100 m roll netto 202,50 |
| 6606 | 6 mm, natural pro Meter | 4,26 / per 100 m roll netto 227,00 |
| 6606.1 | 6 mm, black pro Meter | 5,61 / per 100 m roll netto 299,00 |
| 6603.2 | 6 mm, brown pro Meter | 5,13 / per 100 m roll netto 274,00 |
| 6608 | 8 mm, natural pro Meter | 7,56 / per 100 m roll netto 403,00 |
| 6608.1 | 8 mm, black pro Meter | 9,66 / per 100 m roll netto 483,00 |
| 6603.2 | 8 mm, brown pro Meter | 8,85 / per 100 m roll netto 442,50 |
| | Round leatherbraid thong | |
| 2.1FLK6-19 | black, 6 mm per m | 10,45 |
| | from 100 m per m | 8,55 |
| | Machine belting | |
| 6750 | Core leather belting | |
| | Custom made to measure, glued or open. Prices on demand. | |
| | To glue use No.3535.1 Edelkit from page 41 | |
| 5.1.106960 | Cramp for belting closure | |
| | Cramps on cardboard, 1 strip ca 31 cm | 6,31 |
| | 1 cm opening | |

| Art. No. | Article name | Prices ex VAT. (€) | | |
|------------|---|--------------------|--|--|
| 330 | Zips, webbing, tapes, leathers and upholstery materials (Neopren, felt etc.) | (cont.) | | |

Rawhide

| | | | | |
|------------------|--|---------------------------|-------|-------|
| 6700 | Neck of rawhide ca. 1,5 mm | per sqm. | netto | 72,00 |
| 6700 | .1 Calf rawhide 1 mm | per sqm. | netto | 65,25 |
| 6700 | .HP Parchment deer | per piece | netto | 64,00 |
| 6700 | .ZP Parchment goat | per piece | netto | 60,00 |
| 6706 | Rawhide thongs, 6 mm | Price per kg, ca. 100 pcs | | 86,41 |
| 6706.1 | Rawhide thongs, 6 mm | per pce | | 1,53 |
| 6708.15 | Chrome-tanned leash, endless, 15 x 4 mm | per m. | | 3,98 |
| LF500302 | Rawhide lace, 20 yds. (18,29 m.), 3 mm breit | | | 44,30 |
| LF500302. | | (per Meter) | | 3,63 |

Girth straps

| | | | | |
|-------------|--|-------|--|-------|
| 6800 | Girth straps, Chrome-tanned, short, punched, 32,5 cm | | | |
| | .1.32,5 black | p.pce | | 7,38 |
| | .2.32,5 brown (light-and dark brown) | p.pce | | 7,38 |
| 6800 | Girth straps, Chrome-tanned, short, unpunched , 32,5 cm | | | |
| | .1.32,5 oL black | p.pce | | 7,50 |
| | .2.32,5 oL brown(light- and dark brown) | p.pce | | 5,74 |
| 6800 | Girth straps, Chrome-tanned, long, punched, 75 cm | | | |
| | .1.75 black | p.pce | | 10,38 |
| | .2.75 brown | p.pce | | 10,38 |
| 6800 | Girth straps, Chrome-tanned, long, unpunched , 75 cm | | | |
| | .1.75 oL black | p.pce | | 10,18 |
| | .2.75 oL brown | p.pce | | 10,18 |

Custom straps on demand!

Chrome-tanned leathers

| | | | | |
|----------------|---|-------------------|--------------|--------|
| | Chrome-tanned pikes (1/2), Girth strap leathers | | | |
| 7510 | .1 black | per kg | netto | 42,75 |
| 7510 | .2 brown | per kg | netto | 42,39 |
| 7510 | .4 goldchrom | per kg | netto | 39,90 |
| | Chrom-tanned pike | | | |
| 7300.0 | natural | 2,5-3,0 mm | per kg netto | 39,75 |
| 7300.0 | | 3 - 3,5 mm | per kg netto | 38,63 |
| 7300.0 | | 3,5 - 4 mm | per kg netto | 39,18 |
| 7300.0 | | 4 - 4,5 mm | per kg netto | 39,19 |
| 7300.0 | | 4,5 - 5 mm | per kg netto | 37,88 |
| 7300.1 | black | 4 - 4,5 mm | per kg netto | 42,39 |
| 7300.10 | white | 3 - 3,5 mm | per qm netto | 147,79 |
| 7300.10 | | 3,5 - 4 mm | per qm netto | 154,61 |

The Pike or "Hecht" is the German description for the back,butt & neck of the skin in one piece.
 ½ Pike is cut lengthwise!!

| Art. No. | Article name | Prices ex VAT. (€) | | | |
|----------|---|--------------------|--|--|--|
| 330 | Zips, webbing, tapes, leathers and upholstery materials (Neopren, felt etc.) (cont.) | | | | |

Veg.tanned leathers

| | | | | | |
|---------|--------------------------------|--------------|---------|-------|--------|
| 7111.0 | -neck, <u>natural</u> | 1 - 1,5 mm | per sqm | netto | 69,00 |
| | | 1,5 - 2 mm | per sqm | netto | 78,75 |
| | | 2 - 2,5 mm | per sqm | netto | 94,20 |
| | | 2,5 - 3 mm | per sqm | netto | 79,50 |
| | | 3 - 3,5 mm | per sqm | netto | 90,90 |
| | | 3,5 - 4 mm | per sqm | netto | 88,50 |
| 7111.1 | -neck, <u>black</u> | 2,0 mm | per sqm | netto | 81,00 |
| 7111.1 | -neck, <u>black</u> | 2,8 - 3,0 mm | per sqm | netto | 104,25 |
| 7111.1 | -neck, <u>black</u> | 3 - 3,2 mm | per kg | netto | 96,00 |
| 7111.1 | -neck, <u>black</u> | 3 - 3,5 mm | per kg | netto | 94,76 |
| 7111.1 | -neck, <u>black</u> | 3,2 - 3,7 mm | per kg | netto | 96,00 |
| 7111.2 | -neck, <u>brown (mocca)</u> | 2,8 - 3,0 mm | per sqm | netto | 104,25 |
| 7111.3 | -neck, <u>red</u> | 2,8 - 3,0 mm | per sqm | netto | 104,25 |
| 7111.4 | -neck, <u>green</u> | 2,8 - 3,0 mm | per sqm | netto | 99,75 |
| 7111.5 | -neck, <u>bordeaux</u> | 2,5 - 3,0 mm | per sqm | netto | 99,75 |
| 7111.5 | -neck, <u>bordeaux</u> | 2,8 - 3,0 mm | per sqm | netto | 99,75 |
| 7111.6 | -neck, <u>brown (marron)</u> | 2,8 - 3,0 mm | per sqm | netto | 104,25 |
| 7111.7 | -neck, <u>cognac</u> | 2,8 - 3,0 mm | per sqm | netto | 104,25 |
| 7111.8 | -neck, <u>marine</u> | 2,8 - 3,0 mm | per sqm | netto | 104,25 |
| 7111.9 | -neck, <u>brown (avellana)</u> | 2,8 - 3,0 mm | per sqm | netto | 99,75 |
| 7111.9 | -neck, <u>brown (avellana)</u> | 3,0 - 3,2 mm | per sqm | netto | 99,75 |
| 7111.17 | -neck, <u>white</u> | 2,8 - 3,0 mm | per sqm | netto | 99,75 |

Veg.tanned leathers

| | | | | | |
|------------|---|--------------|---------|-------|-------|
| 7111.0K-SP | neck, <u>natural</u> strong (lickered) | 3 - 3,5 mm | per sqm | netto | 45,75 |
| 7111.0K-SP | soft (tumbled) | 3 - 3,5 mm | per sqm | netto | 45,75 |
| | Orthopaedic deth tanned tumbled leather | | | | |
| 7111W | .1,5 - 2 mm | | per sqm | netto | 99,30 |
| 7111W | .2 - 2,5 mm | | per sqm | netto | 99,30 |
| 7112.0 | -Pike, <u>natural</u> | 2,0 - 2,5 mm | per sqm | netto | 90,00 |
| | | 2,5 - 3 mm | per sqm | netto | 91,50 |
| | | 3 - 3,5 mm | per sqm | netto | 93,00 |
| | | 3,5 - 4 mm | per sqm | netto | 99,00 |
| | | 4,0 - 4,5 mm | per kg | netto | 30,38 |
| | | 4,5 - 5 mm | per kg | netto | 30,38 |

| Art. No. | Article name | Prices ex VAT. (€) | | | |
|------------|---|--------------------|--|--|--|
| 330 | Zips, webbing, tapes, leathers and upholstery materials (Neopren, felt etc.) | (cont.) | | | |

| | | | | | |
|--|------------------------------------|-----------|----|---------|--------------|
| Rein & bridle leathers (veg.tanned, ½ pike) | | | | | |
| 7112.0 Rzl | <u>-natural</u> | 2,5 - 3 | mm | per kg | netto 43,50 |
| 7112.0 Rzl | <u>-natural</u> | 3 - 3,5 | mm | per kg | netto 40,13 |
| 7112.1 Rzl | <u>-black</u> | 2,0 - 2,5 | mm | per sqm | netto 143,21 |
| 7112.1 Rzl | <u>-black</u> | 2,5 - 3 | mm | per kg | netto 48,81 |
| 7112.1 Rzl | <u>-black</u> | 3 - 3,5 | mm | per kg | netto 46,30 |
| 7112.1 Rzl | <u>-black</u> | 3,5 - 4 | mm | per kg | netto 43,10 |
| 7112.2 Rzl | <u>-brown (negro)</u> | 2,0 - 2,5 | mm | per sqm | netto 143,21 |
| 7112.2 Rzl | <u>-brown (negro)</u> | 2,5 - 3 | mm | per kg | netto 46,31 |
| 7112.2 Rzl | <u>-brown (negro)</u> | 3 - 3,5 | mm | per kg | netto 43,82 |
| 7112.2 Rzl | <u>-brown (negro)</u> | 3,5 - 4 | mm | per kg | netto 43,11 |
| 7112.4 Rzl | <u>-havanna</u> | 2,0 - 2,5 | mm | per sqm | netto 143,21 |
| 7112.4 Rzl | <u>-havanna</u> | 2,5 - 3 | mm | per kg | netto 45,60 |
| 7112.4 Rzl | <u>-havanna</u> | 3 - 3,5 | mm | per kg | netto 43,82 |
| 7112.4 Rzl | <u>-havanna</u> | 3,5 - 4 | mm | per kg | netto 43,11 |
| 7112.5 Rzl | <u>-london-colour</u> | 2,5 - 3 | mm | per kg | netto 43,50 |
| 7112.5 Rzl | <u>-london-colour</u> | 3 - 3,5 | mm | per kg | netto 47,86 |
| 7112.5 Rzl | <u>-london-colour</u> | 3,5 - 4 | mm | per kg | netto 38,63 |
| 7112.9 Rzl | <u>-red brown</u> | 2,5 - 3 | mm | per kg | netto 43,50 |
| 7112.9 Rzl | <u>-red brown</u> | 3,0 - 3,5 | mm | per kg | netto 45,92 |
| 7112.9 Rzl | <u>-red brown</u> | 3,5 - 4 | mm | per kg | netto 40,75 |
| 7113.0 | -Croupons, <u>natural</u> | 2,5 - 3, | mm | per sqm | netto 108,60 |
| | | 3 - 3,5 | mm | per kg | netto 27,75 |
| | | 3,5 - 4 | mm | per sqm | netto 111,00 |
| | | 4,5 - 5 | mm | per sqm | netto 121,65 |
| 7113.1 | -Croupons, <u>black</u> | 2,5 - 3,0 | mm | per kg | netto 43,90 |
| | | 3,5 - 4 | mm | per kg | netto 48,45 |
| | | 4 - 4,5 | mm | per kg | netto 38,65 |
| 7113.2 | -Croupons, <u>negro-brown</u> | 3,5 - 4 | mm | per kg | netto 39,37 |
| 7113.5 | -Croupons, <u>london color</u> | 2,5 - 3,0 | mm | per kg | netto 43,90 |
| Veg. tanned leather ½ skin | | | | | |
| 7114.0 | 0,8 - 1,2 mm <u>-natural</u> | | | per sqm | netto 51,75 |
| 7114.0 | 1,2 - 1,5 mm <u>-natural</u> | | | per sqm | netto 86,57 |
| 7114.0 | 1,5 - 2 mm <u>-natural</u> | | | per sqm | netto 63,00 |
| 7114.0 | 1,0 - 1,5 mm <u>-black</u> | | | per sqm | netto 63,75 |
| 7114.1 | 1,5 - 2 mm <u>-black</u> | | | per sqm | netto 63,75 |
| 7114.0 | 2,2 - 2,4 mm <u>-black</u> | | | per sqm | netto 69,75 |
| 7114.1 | 1,5 - 2 mm <u>-brown (negro)</u> | | | per sqm | netto 72,00 |
| 7114.2 | 2,0 - 2,5 mm <u>-brown (negro)</u> | | | per sqm | netto 69,75 |
| HL-Dog-lead Leathers (half pike) | | | | | |
| 7200.1 | <u>-black</u> | 3 - 3,5 | mm | per sqm | netto 112,50 |
| 7200.2 | <u>-dark brown</u> | 3 - 3,5 | mm | per sqm | netto 112,50 |
| Veg.tanned leash leather pikes | | | | | |
| 7210 | <u>-londoncolor</u> | 3 - 3,5 | mm | per kg | netto 43,82 |
| 7210 | <u>-londoncolor</u> | 3,5 - 4 | mm | per kg | netto 37,50 |
| 7210 | <u>-londoncolor</u> | 4 - 4,5 | mm | per sqm | netto 209,12 |
| 7210 | <u>-londoncolor</u> | 4,5 - 5 | mm | per kg | netto 32,25 |
| Sole leathers | | | | | |
| 7218 | Croupon | 2,5 - 3,0 | mm | per kg | netto 28,50 |
| 7218 | Croupon | 3,0 - 3,5 | mm | per kg | netto 23,25 |
| 7218 | Croupon | 3,5 - 4,0 | mm | per kg | netto 23,25 |
| 7218 | Croupon | 4,0 - 4,5 | mm | per kg | netto 28,50 |
| 7218 | Croupon | 4,5+ | mm | per kg | netto 28,50 |

Art. No. Article name Prices ex VAT. (€)

330 Zips, webbing, tapes, leathers and upholstery materials (Neopren, felt etc.) (cont.)

Harness leathers

| | | | | | |
|--------|----------------------------------|--------------|---------|-------|--------|
| 7121.0 | -neck, <i>natural</i> | 4 - 5 mm | per kg | netto | 25,50 |
| 7122.0 | -pike, <i>natural</i> | 4 - 4,5 mm | per kg | netto | 30,38 |
| | | 4,5 - 5 mm | per kg | netto | 27,75 |
| 7122.1 | -pike (1/2), <i>black</i> | 2,0 - 2,5 mm | per sqm | netto | 118,50 |
| 7122.1 | -pike (1/2), <i>black</i> | 3,0 - 3,5 mm | per kg | netto | 44,54 |
| 7122.1 | -pike (1/2), <i>black</i> | 3,5 - 4 mm | per kg | netto | 41,33 |
| 7122.1 | -pike (1/2), <i>black</i> | 4 - 4,5 mm | per kg | netto | 41,33 |
| 7122.1 | -pike (1/2), <i>black</i> | 4,5 - 5 mm | per kg | netto | 43,47 |
| | Grainside dyed only | | | | |
| 7122.2 | -pike (1/2), <i>brown</i> | 3,0 - 3,5 mm | per kg | netto | 34,50 |
| 7122.2 | -pike (1/2), <i>brown</i> | 3,5 - 4 mm | per kg | netto | 32,25 |
| 7122.2 | -pike (1/2), <i>brown</i> | 4 - 4,5 mm | per kg | netto | 31,13 |
| 7122.4 | -pike (1/2), <i>drk. havanna</i> | 4 - 4,5 mm | per kg | netto | 41,25 |

| | | | | | |
|--------|--------------------------|------------|---------|-------|--------|
| 7123.0 | -Croupon, <i>natural</i> | 4 - 4,5 mm | per sqm | netto | 115,50 |
| 7123.0 | -Croupon, <i>natural</i> | 4,5 - 5 mm | per kg | netto | 28,50 |

Fallow leathers

| | | | | | |
|--------|----------------------------|--------------|---------|-------|--------|
| 7131.0 | -neck, <i>natural</i> | 1 - 1,5 mm | per sqm | netto | 70,50 |
| | | 1,5 - 2 mm | per sqm | netto | 79,50 |
| | | 2 - 2,5 mm | per sqm | netto | 79,50 |
| | | 2,5 - 3 mm | per sqm | netto | 96,15 |
| | | 3 - 3,5 mm | per sqm | netto | 81,00 |
| | | 3,5 - 4 mm | per sqm | netto | 98,25 |
| 7132.0 | -pike, <i>natural</i> | 1,5 - 2 mm | per sqm | netto | 86,25 |
| | | 2 - 2,5 mm | per sqm | netto | 113,85 |
| | | 2,5 - 3 mm | per sqm | netto | 91,50 |
| | | 3 - 3,5 mm | per sqm | netto | 113,85 |
| | | 3,5 - 4 mm | per sqm | netto | 121,95 |
| 7133.0 | -Croupions, <i>natural</i> | 2,5 - 3 mm | per sqm | netto | 103,50 |
| | | 3 - 3,5 mm | per sqm | netto | 80,53 |
| | | 3,5 - 4 mm | per sqm | netto | 88,96 |
| 7134. | -Sides, <i>natural</i> | 0,8 - 1 mm | per sqm | netto | 42,00 |
| | | 1 - 1,2 mm | per sqm | netto | 42,00 |
| | | 1,3 - 1,5 mm | per sqm | netto | 42,00 |
| | | 1,5 - 2 mm | per sqm | netto | 42,00 |
| | | 2 - 2,5 mm | per sqm | netto | 42,00 |

Fat-lubricated leather necks, „Old Germany“

| | | | | | |
|--------|--|------------|---------|--|-------|
| 7150.0 | | 1,5 - 2 mm | per sqm | | 78,50 |
| 7150.0 | | 2 - 2,5 mm | per sqm | | 78,50 |
| 7150.0 | | 2,5 - 3 mm | per sqm | | 78,50 |
| 7150.0 | | 3 - 3,5 mm | per sqm | | 78,50 |
| 7150.0 | | 3,5 - 4 mm | per sqm | | 78,50 |
| 7150.0 | | 4,5 - 5 mm | per sqm | | 78,50 |

**Strap cutting services from pikes possible. Prices go up at least 30% per kilo.
Please order correct width.Length is up to 2,20 mtr depending on the skin length!**

| Art. No. | Article name | Prices ex VAT. (€) | | |
|------------|---|--------------------|--|--|
| 330 | Zips, webbing, tapes, leathers and upholstery materials (Neopren, felt etc.) | (cont.) | | |

Vachette/Pikes

| | | | | |
|------------------------------|--|----------|-------------|--------------|
| | Fallow-vachette, <i>natural</i> | | | |
| 7400.0 1 – 1,5 | 1,0 -1,5 mm | per sqm | netto | 58,50 |
| 7400.0 | 1,5 – 2 mm | per sqm | netto | 63,75 |
| 7400.0 2,5 | up to 2,5 mm | per sqm | netto | 66,75 |
| | Saddle-pad pikes | | | |
| 7400.1 | <i>black</i> , 1,4 mm | per sqm | netto | 96,75 |
| 7400.2 | <i>brown</i> , 1,4 mm | per sqm | netto | 96,75 |
| | Seat- and saddle pad Vachette | | | |
| 7410.1 1,8 – 2,0 | 1,8 – 2, 0 mm, <i>black</i> | per sqm | netto | 65,25 |
| | Seat- and saddle pad Vachette (special sale) | | | |
| 7410.1 1,8 – 2,0 SPJ | 1,8 – 2, 0 mm, <i>black</i> | per sqm | netto | 45,00 |
| 7410.2 1,8 – 2,0 SPJ | 1,8 – 2, 0 mm, <i>brown</i> | per sqm | netto | 45,00 |
| 7410.13 1,8 – 2,0 SPJ | 1,8 – 2, 0 mm, <i>diverse colours</i> | per sqm | netto | 45,00 |
| 7411.0 2,5 | Chrome-tanned lining-leather, <i>natural</i> | per sqm | netto | 43,50 |
| 7416.0 2,5-3 | Chrome-tanned suede splits, <i>natural</i> , 2,5 - 3 mm | pers qm | netto | 42,75 |
| 7416.1 | <i>black</i> 2,2 – 2,4 mm | | | 22,50 |
| 7416.2 | <i>brown</i> | | | 22,50 |
| 7416.4 | <i>div. colours</i> | | | 18,50 |
| 7420.0 | 2,0 – 2,5 Horse-collar pad vachette, <i>natural</i> | per sqm | netto | 61,50 |
| 7420.1 | <i>black</i> , 2,0 mm | per sqm | netto | 88,50 |
| 7420.2 | <i>black</i> , up to 2,0 mm | per sqm | netto | 64,53 |
| 7415.1 | Chrome-tanned Vachette, <i>black</i> , 3 - 3,5 mm | per sqm | netto | 67,70 |
| 7430.1 | Car-seat leathers, <i>black</i> | | | |
| | n Bovine nappa | per sqm | netto | 43,50 |
| | gn Bovine plated | per sqm | netto | 43,50 |
| | Furniture leathers | | | |
| 7440.1 | „Natura“, <i>black</i> | per sqm | netto | 45,00 |
| 7440.2 | „Natura“, <i>brown</i> | per sqm | netto | 45,00 |
| | Veg.tanned goat, <i>natural</i> | | | |
| 7462. | 1,8 – 2 mm | per sqm | netto | 48,48 |
| 7449 | Suede split Croupon | per sqm | netto | 23,00 |
| | Offcuts & leftovers of furniture & dressmaker leathers | | | |
| | Different colours & sizes | | | |
| 7456 | .1 sorted per size | per kg | | 10,00 |
| 7456 | .2 dto. | per kg | | 15,00 |
| 7456 | .3 dto. | per kg | | 20,00 |
| 7456 | .4 Special sale | per sqm | | 20,00 |
| 7456 | .4 qfs Special sale | per sqft | | 1,87 |
| 7456 | .5 offcuts | per kg | | 24,00 |
| 7456 | .6 Bovine leathers | per kg | | 37,00 |
| 7456 | .7 Fine dressmaking leatherrs | per kg | | 50,00 |
| 7456 | .8 qfs chamoised goat | per sqft | | 2,40 |
| 7457 | veg .tanned offcuts | per kg | sale | 11,80 |
| 7457.2 | from 0,4 sqm pieces | per kg | sale | 15,00 |
| 7457.2 | 1 – 1,5 m long | per kg | sale | 24,00 |

| Art. No. | Article name | | Prices ex VAT. (€) |
|-----------------|---|----------|--------------------|
| 330 | Zips, webbing, tapes, leathers and upholstery materials (Neopren, felt etc.) (cont.) | | |
| 7460 | Lamb nappa <i>black</i> | per sqft | 4,78 |
| 7460.3 | Lamb nappa <i>red</i> | per sqft | 5,80 |
| 7461 | Window wipers, <i>chamois</i> | per pce | 13,03 |
| 7462.007 | Different-coloured goat-skins | per sqm | 25,82 |
| 7462.0 1,8 -2,0 | veg.tanned goa-skint , <i>natural</i> | per sqm | 48,48 |
| 7465.1 | Kangaroo Leathers, <i>black</i> | per sqm | 87,00 |
| | Pearl-ray skins | | |
| 7777 | .10x25 cm (Gr.4) | p.pce | 26,06 |
| | .13x30 cm (Gr.5) | p.pce | 31,94 |
| | .15x40 cm (Gr.6) | p.pce | 84,00 |
| | .18x45 cm (Gr.7) | p.pce | 53,78 |

| Art. No. | Article name | | Prices ex VAT. (€) |
|---|---|-------------------|--------------------------------|
| 330 Zips, webbing, tapes, leathers and upholstery materials (Neopren, felt etc.) (cont.) | | | |
| | Furs & skins | | |
| | Rabbit | | |
| 7650 | .1 small | p. pce | 8,40 |
| | .2 medium | p. pce | 10,00 |
| | .3 large | p. pce | 12,60 |
| | .4 extra large | p. pce | 16,80 |
| | Sheep skins | | |
| 7600 | sortiment 1 a, origin northern Germany | netto | 37,50 |
| | . B B supplement | netto | 30,00 |
| | .LH Long-haired | netto | 30,40 |
| | Sheep skins, medical tanned, washable | | |
| 7601 | up to ca. 110 cm | netto | 55,00 |
| 7601.120 | from ca. 120 cm | netto | 67,20 |
| 7601.130 | from ca. 130 cm | netto | 85,00 |
| 7601.150 | from ca. 150 cm | netto | 90,00 |
| 7699.1 | Artificial skin, natural-yellow ca. 157 cm wide | lfm | 24,00 temporarily out of stock |
| 7699.3 | Artificial skin,black ca. 212 cm wide | lfm | 24,00 temporarily out of stock |
| 7599 | Co- or Bull skin (Prices on demand) Other skins and leathers on demand! | | |
| Fabrics / textiles / Foils / artificial leathers | | | |
| 7700 | Horse collar twill ca. 1,60 m width | per running meter | 44,00 |
| | Jute-canvas ca. 1,20 wide | | |
| 7703. | H215/120 , rough | per running meter | 3,98 |
| 7703. | H365/120 , fine | per running meter | 5,60 |
| 7710.100 | Canvas-sailcloth, oliv 550gs/qm, 1,00 m wide | per r.mtr | 10,50 |
| 8.1.556 | Sailcloth, white polyester / cotton 50/50 | per r.mtr | 31,00 |
| 7711.6 | Heavy cloth – Blanket „Robusta” ca. 1,05m wide | per r. mtr | 6,90 |
| | Artificial Leathers | | |
| 7901 | black 1,40 m wide | per r. mtr | 17,79 |
| 7900 | .370 dark brown 1,40 m wide | per r. mtr | 19,00 |
| 7900 | .805 lightbrown 1,40 m wide | per r. mtr | 17,79 |
| 7900 | .1204 brown 1,40 m wide | per r. mtr | 17,79 |
| 7900 | .3120 grey 1,40 m wide | per r. mtr | 17,79 |
| | PVC-webbed foil, 2,5 m wide | | |
| 7910 | .7200, aluminum-grey | qm | 10,30 |
| | Other colours on demand | | |
| | Clear window PVC | | |
| 7999 | .020 0,20 mm, wide 1,3 m | per r. mtr | 11,50 |
| 7999 | .040 0,40 mm, wide 1,3 m | per r. mtr | 12,00 |
| 7999 | .045 0,45 mm, wide 1,3 m | per r. mtr | 13,50 |
| 7999 | .075 0,75 mm, wide 1,3 m | per r. mtr | 28,50 |
| 7999 | .100 1,00 mm, wide 1,3 m | per r. mtr | 28,50 |

| Art. No. | Article name | Prices ex VAT. (€) | |
|-----------------------|---|--------------------|--------|
| 330 | Zips, webbing, tapes, leathers and upholstery materials (Neopren, felt etc.) (cont.) | | |
| | Felts | | |
| | Pure woolen felt, grey, ca. 1,85 m wide | | |
| 9000 | .5 mm , | per sqm | 27,60 |
| 9000 | .10 mm , | per sqm | 49,80 |
| 9000 | .15 mm , | per sqm | 77,80 |
| 9000 | .20 mm , | per sqm | 99,30 |
| 9000.2219 | .02 2 mm , 0,72 kg / sqm | per sqm | 36,00 |
| 9000.2219-028 | .10 10 mm 0,28 g / cm3 | per sqm | 84,20 |
| 9010 | Striped felt, .5 mm | per sqm netto | 13,70 |
| | Foam rubber / Neopren | | |
| | Foam rubber, plate ca. 1,4 sqm | | |
| 9040 .015 | 1,5 mm (cellular rubber) | per sqm | 11,50 |
| 9040 .02 | 2 mm (dto.) | per sqm | 11,50 |
| 9040 .03 | 3 mm (dto.) | per sqm | 14,50 |
| 9040 .05 | 5 mm (dto.) | per sqm | 25,75 |
| 9040.05 SK 523 | 5 mm (dto.) on side self adhesive | per sqm | 32,38 |
| 9040 .06 | 6 mm (dto.) | per sqm | 25,88 |
| 9040 .08 | 8 mm (dto.) | per sqm | 40,25 |
| 9040 .10 | 10 mm (dto.) | per sqm | 48,25 |
| 9040 .15 | 15 mm (dto.) | per sqm | 72,00 |
| 9040 .20 | 20 mm (dto.) | per sqm | 90,75 |
| 9040 .30 | 30 mm (dto.) | per sqm | 134,50 |
| | Neopren, pane ca. 2,9 qm | | |
| 9042.02GH | black, 2 mm, smooth skinned, | per pane | 34,00 |
| 9042.02HAI | black, 2 mm, Anti-slide, | per pane | 40,00 |
| 9042.02 | black, 2 mm, open sides | per pane | 28,00 |
| 9042.03GH | black, 3 mm, smooth skinned, | per pane | 47,00 |
| 9042.03OZ/J | black, 3 mm, open side+ Jersey | per pane | 62,50 |
| 9042.03 | black, 3 mm, open sides | per pane | 41,00 |
| 9042.03J/J | black, 3 mm, both sides Jersey | per pane | 86,00 |
| 9042.05GH | black, 5 mm, smooth skinned | per pane | 73,00 |
| 9042.05 GH/J | black, 5 mm, smoothside + Jersey | per pane | 94,50 |
| 9042.05 OZ/J | black, 5 mm, open + Jersey | per pane | 88,50 |
| 9042.05 J/J | black, 5 mm, Jersey + Jersey | per pane | 112,00 |
| 9042.05 | black, 5 mm, open sides | per pane | 67,00 |
| 9042.06 | black, 6 mm, open sides | per pane | 88,50 |
| 9042.06 GH | black, 6 mm, smooth skinned | per pane | 86,00 |
| 9042.08 | black, 8 mm, open sides | per pane | 106,00 |
| 9042.08 GH | black, 8 mm, smooth skinned | per pane | 112,00 |
| 9042.10 GH | black, 10 mm, smooth skinned | per pane | 138,00 |
| 9042.10 OZ/J | black, 10 mm, open + Jersey | per pane | 153,20 |
| 9042.10 | black, 10 mm, open sides | per pane | 132,00 |
| 9042.15 GH | black, 15 mm, smooth skinned | per pane | 203,00 |
| 9042.15 | black, 15 mm, open sides | per pane | 197,00 |

Other sizes on demand

Different coloured Jersey on demand.

Half panes on demand.

| Art. No. | Article name | Prices ex VAT. (€) | |
|----------------------|--|-------------------------------|----------------------------------|
| 330 | Zips, webbing, tapes, leathers and upholstery materials (Neopren, felt etc.) | (cont.) | |
| 9049.25 | Composite foam panes 1000 x 1500 x 25 mm | per qm | 39,33 |
| | Foam panes | | |
| 9050 | Foam pane grey A1572.20 pane 2000 x 1000 x 20 | per sqm | 27,00 |
| 9050 | Foam pane, black A1562.10 pane 2000 x 1000 x 10 A1562.20 panel 2000 x 1000 x 20 A1562.40 pane 2000 x 1000 x 40 Other sizes and qualities on demand. | per sqm per sqm per sqm | 8,10 18,90 37,60 |
| 9058. | PE-Foam panes, black L1668.15 , 10 mm | per sqm | 15,50 |
| 9058. | L1668.15 , 15 mm | per sqm | 22,65 |
| 9058. | L1668.15 , 20 mm | per sqm | 26,50 |
| 9058. | L1668.15 , 50mm | per sqm | 49,00 |
| 1.3.D6001O | Latex foam 9 mm x 2 m x 0,8 m | per pane | 58,80 |
| 1.3.D6001Z | 19 mm x 1,8 m x 1,4 m | per pane | 127,40 |
| R008700 | Natural crepe, 8 mm Original pane 33x 91 cm , ca 2,04 kg | per kg | 45,69 (temrorarily out of stock) |
| LF 8910240100 | Natural crepe, 70 x 50 x 10 mm | per piece | 3,63 |

| Art. No. | Article name | Prices ex VAT. (€) | | |
|-------------------|--|--------------------|-------|-------|
| 330 | Zips, webbing, tapes, leathers and upholstery materials (Neopren, felt etc.) (cont.) | | | |
| | Stuffing material | | | |
| 8001 | Polyester saddle stuffing, white per kilo or Cardboard-box from 6 to 13 kg) | per kg | | 7,01 |
| 8002 | Polyester saddle stuffing, white Bale price (from 50 kg) 1 = 25– 30 kg | per kg | netto | 5,23 |
| 8003.30/70 | Saddle stuffing, 30/70 polyester/ silicon, white .1 per kilo or box from 6 to 13 kilo | per kg | | 8,17 |
| 8003.30/70 | .2 Bale price 1 = 25-30 kg | per kg | netto | 5,94 |
| 8004. | Saddle stuffing endless string polyester .1 | per kg | | 7,65 |
| 8004. | .2 from 50 kg | per kg | netto | 5,74 |
| 8005 | Saddle stuffing silicon balls .1 Polyester /silic.-balls , 1 sack 7 kg | per kg | | 5,60 |
| 8005 | .2 Polyester /silic.-balls , 10 sacks 70 kg | per kg | netto | 4,90 |
| 8006 | Kapok stuffing | per kg | | 33,60 |
| 8009 | Sheep wool,+ 15% silicon, grey de-clogged ca. 10 kg box oder per kilo from 1 sack = ca. 30 kg from 3 sacks = ca. 90 kg | per kg | | 11,33 |
| | | per kg | netto | 8,50 |
| | | per kg | netto | 7,73 |
| | Sheep wool natural de-clogged - silicon additive | | | |
| 8009.N P | .1 ca. 10 kg box or per kilo | per kg | | 9,80 |
| | .2 from 30 kg/bale | per kg | netto | 7,33 |
| | - polyester additive | | | |
| 8009.N SIL | .1 ca. 10 kg box or per kilo | per kilo | | 9,24 |
| | .2 from 30 kg/bale | per kilo | netto | 6,93 |
| | Sheep wool endless string stuffing | | | |
| 8009.ELS-N | . 1 bunch ca. 2,5 kg | per kg | | 12,60 |
| | . 2 from 50 kg | per kg | netto | 9,45 |
| | Horsehair | | | |
| 8010.A | Horsehair, twisted | per kg | | 28,10 |
| 8010.A GZ | Horsehair, plucked | per kg | | 29,40 |
| 8010.B | Tail hair horse/other mammal | unit 5 kg | | 39,80 |
| 8010.C | Tail hair | unit 5 kg | | 50,80 |

MAUTHE



Art. 395 mit Art. 205

Mauthe-Messer

aus Edelstahl
sind scharf
schnitthaltig
formvollendet

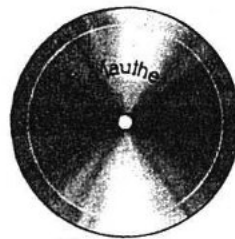

Art. 170

Mauthe-Werkzeuge

im Gesenk geschmiedet
beste Stahlqualität
sind hieb- und stoßfest
elastisch im Gebrauch

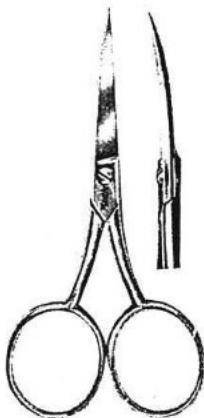

Art. 280 / 100 mm



Art. 650 / 250 mm

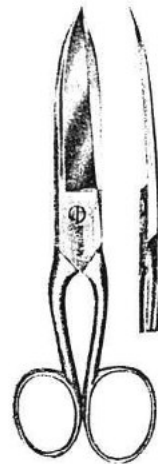

Art. 635 B / 180 mm

Auf Wunsch auch in gerader Länge

Auf Wunsch auch in gerader Länge

Wir liefern »Spezialmesser« für jeden Verwendungszweck nach Skizze oder Modellvorlage!

Der Universal-Messerhalter - unübertroffen!

Dieser solide, handliche Messerhalter und Markierer zugleich, spannt jedes Zuschneidemesser von 8–10 mm Breite unverrückbar fest.

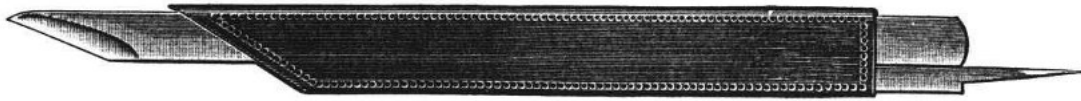

Festspannen des Messers durch Druck, Lösen des Messers durch einfachen Gegendruck laut Gebrauchsanweisung. Fast restloses Aufarbeiten Ihrer Messer ermöglicht.

Art. 110 = Universal-Messerhalter-Ausführung für Zuschneidemesser von 8–10 mm Breite verwendbar



Art. 156 **Zuschneidemesser**, aus feinstem Edelstahl, ca. 10 mm breit, ca. 300 mm lang



Art. 157 **Zuschneidemesser**, sogen. Ritzer, lanzenförmige Schneide. ca. 10 mm breit, ca. 250 mm lang



Art. 210 **Zuschneidemesser**, flacher Edelstahl, 6 mm breit, 150 mm lang

Art. 211 **Zuschneidemesser**, flacher Edelstahl, 8 mm breit, 200 mm lang

Art. 212 **Zuschneidemesser**, flacher Edelstahl, 10 mm breit, 200 mm lang

Art. 212 **Zuschneidemesser**, flacher Edelstahl, 10 mm breit, 230 mm lang

Art. 205 **Zuschneidemesser**, aus feinstem Lin-
senprofilstahl mit **gerader** Schneide, ca. 125 mm
lang, für Messerheft Art. 390, 395 und 400 ver-
wendbar



Art. 390 **Zuschneide-Messerheft**, verstellbar
durch Drehen des runden Heftes, für die Messer
Art. 205 oder 210 verwendbar, aus rostfreiem
Edelstahl hergestellt

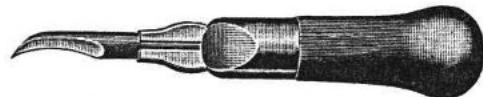

Art. 395 **Zuschneide-Messerheft**, mit flachem
hohlem Metallgriff, 140 mm lang. Verstellbar
durch Ein- und Ausschoben der Metallzwin-
ge, mit Abstechnadel laut Abbildung, verwendbar für
Messer Nr. 205 und Nr. 210



Art. 400 Dasselbe Messerheft, **ohne** Abstech-
nadel

Art. 100 **Zuschneidemesser**, mit Holzheft und
ausziehbarer Klinge, 14 mm breit, ca. 200 mm
lang

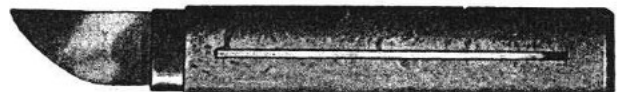

Ersatzmesser hierfür

Art. 105 Dasselbe **Zuschneidemesser**, 25 mm
breit, ca. 200 mm lang

Ersatzmesser hierfür

Art. 170 **Kreismesser**, in allen Abmessungen,
nach Vorschrift, Modellvorlage oder Skizze





Art. 112 **Schuhmachermesser**, leicht aufgebogen, aus feinstem konischem Material, ca. 22 mm breit, 270 mm lang, Rechtsschliff



Art. 114 **Wiener Schärfmesser**, aus feinstem, konischem Material, am ganzen Stück gebogen, ca. 15 mm breit, 240 mm lang



Art. 118 **Modelliermesser** in ganz gerader Ausführung, extra schwere Qualität, aus feinstem konischem Material, ca. 22 mm breit, ca. 300 mm lang



Art. 108 **Schuhmachermesser** schwedisches Modell, feinste Güte. Gebogen, auf Wunsch ganz gerade Ausführung, ca. 24 mm breit, ca. 230 mm lang

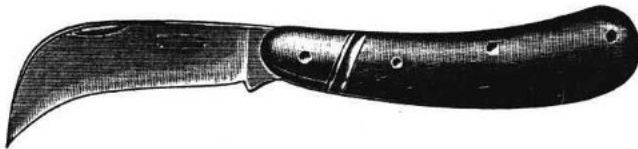

Art. 360 **Trennmesser** zuklappbar, mit solidem Heft, feinste Ausführung, Gesamtlänge ca. 190 mm



Art. 1200 **Putzmesser** mit Holzgriff, spitze Form, ca. 85 mm Klingenlänge, Holzgriff ca. 95 mm



Art. 1400 **Gummibeschnidmesser**, 10 cm Klingenlänge, mit Holzgriff, elsässische Form



Art. 1402 **Gummibeschnidmesser, bayerische Form**, Klingenlänge . . . 15 cm 20 cm 25 cm



Art. 1600 **Gummibeschnidmesser**, Block-Form, Klingenlänge 31 cm, Gesamtlänge 45 cm

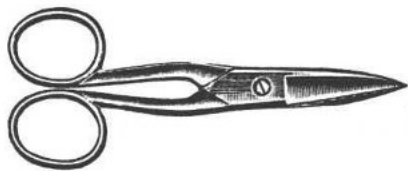

Art. 640 **Lochscherer** Ia Qualität, handliche Form, Normallänge ca. 125 mm, vernickelt, **gerade**

Art. 645 **Dieselbe** Schere in **gebogen**

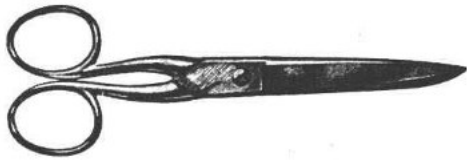

Art. 638 **Steppereischere** Ia Qualität, **gerade** Form, Normallänge ca. 160 mm, vernickelt

Art. 638 **Dieselbe** Schere, ca. 145 mm lang
ca. 130 mm lang
ca. 110 mm lang

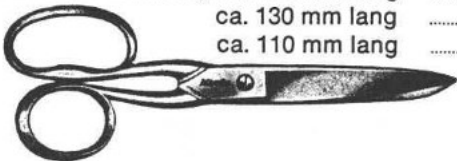

Art. 639 **Steppereischere** Ia Qualität, **gerade** Form mit 1 langen Auge, ca. 160 mm lang, vernickelt

Art. 639 **Dieselbe** Schere, ca. 180 mm lang
ca. 200 mm lang

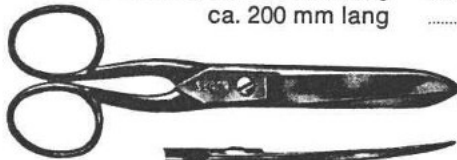

Art. 635 S **Steppereischere** Ia Qualität, aufgebogene schmale Form, ca. 160 mm lang, lackierte Schenkel

Art. 635 S **Dieselbe** Schere, ca. 180 mm lang

Art. 635 B **Steppereischere**, aufgebogen, **extra breit**, blank, ca. 180 mm lang (siehe Abbildung Vorderseite!)

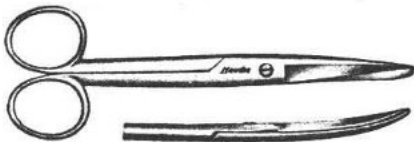

Art. 453/N **gebogene Schere**, vernickelt, schmal, ca. 170 mm lang

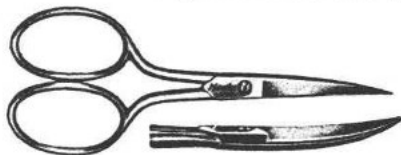

Art. 528/U **gebogene Schere**, mit zwei extra großen Augen, ca. 160 mm lang, schmale spitzige Form

Dieselbe Schere in **gerader** Ausführung

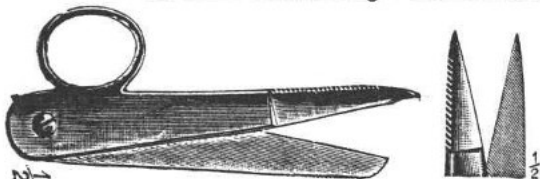

Art. 660

Einringschere, 100 mm lang, rostfrei, stets **gebrauchsbereit** in der rechten Hand am **Ringfinger**, die andern Finger sind nicht behindert. Öffnet sich selbsttätig.

Art. 660 Mit **Hakenspitze**, gerade Form

Art. 661 Mit **spitzer Spitze**, gerade Form

Art. 662 Mit **spitzer Spitze**, **aufgebogene** Form

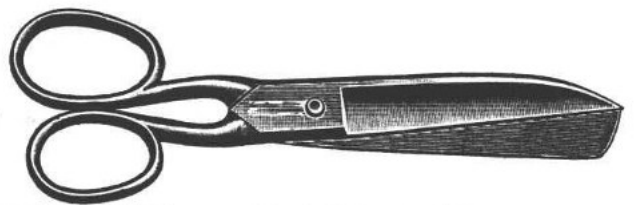

Art. 620 **Materialschere**, solide **kräftige** Ausführung aus blankem Stahl, für Leder und andere Stoffe Normallänge ca. 205 mm

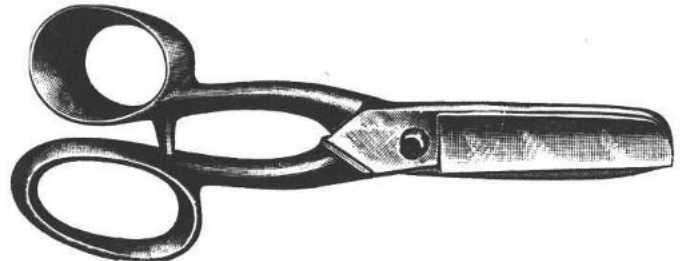

Art. 610 **Lederschere** mit **Zahnung**, extra starke gerade Ausführung, mit **kräftigen** Schenkeln Normallänge ca. 220 mm



Art. 611 **Dieselbe** Schere in **gebogen**

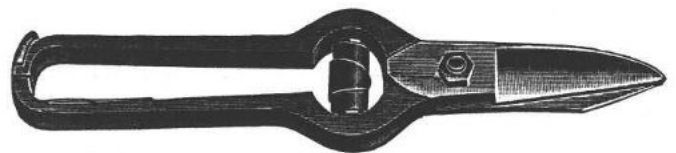

Art. 615 **Lederschere** mit **Feder** und **Zahnung** Normallänge ca. 220 mm

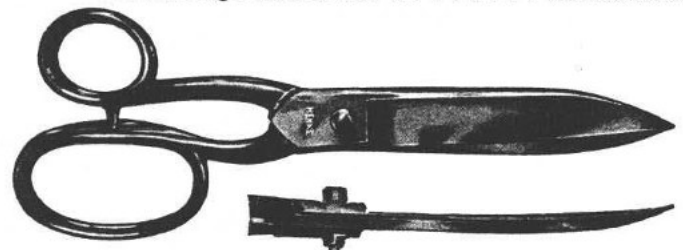

Art. 636 Große **Beschneidschere** aufgebogen, mit 1 langen Auge, ca. 230 mm lang

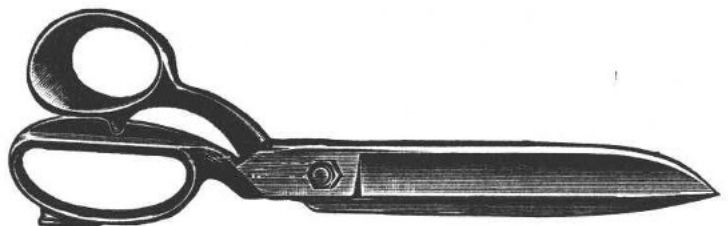

Art. 1160 **Schneiderschere** oder **Zuschneideschere** in erstklassiger Ausführung
ca. 200 mm lang ca. 230 mm lang
ca. 250 mm lang ca. 300 mm lang

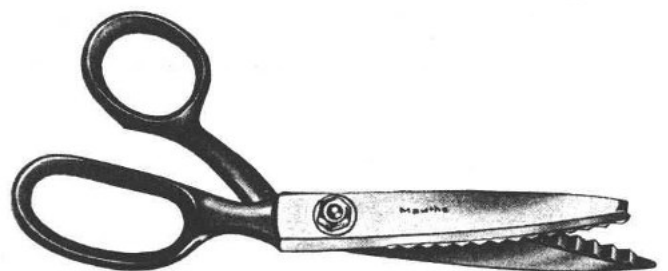

Zackenschere Blätter vernickelt, Halm und Augen schwarz lackiert, Zacken gehärtet

Art. 1802 20 cm lang Art. 1803 23 cm lang

Im Gesenk geschmiedete Stahlwerkzeuge in bester Güte!

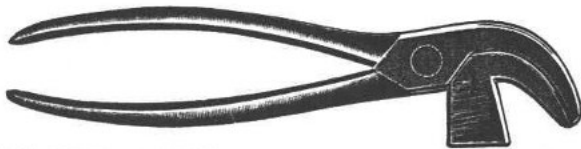

Art. 820 Ia **Zwickzange**, handliches Modell, ca. 22 cm lang, in Maulbreite ca. 10 mm oder ca. 12 mm

Art. 820 SM **Dieselbe Zange** mit Magnethammer in handgeschmiedeter Stahlausführung, ca. 22 cm lang, ca. 10 mm Maulbreite

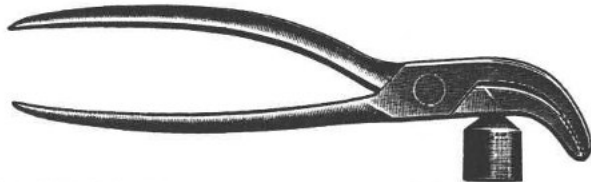

Art. 830 **Überholzange** mit schwerem, rundem Hammer und ca. 15 mm breitem Maul, ca. 22 cm lang

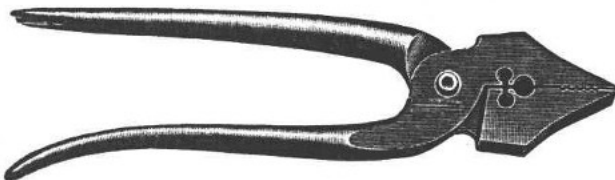

Art. 860 **Falzzange** mit geradem, schmalem Maul

Art. 865 **Falzzange** mit geradem, breitem Maul

Art. 870 **Falzzange** mit gebog., schmalem Maul

Art. 875 **Falzzange** mit gebog., breitem Maul
einheitliche Länge ca. 21 cm

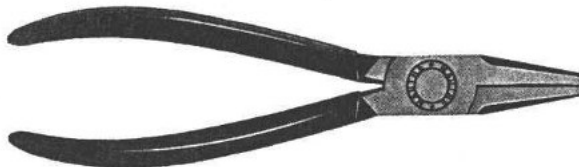

Art. 880 **Flachzange** ca. 200 mm lang, mit 12 mm breitem Maul



Art. 882 **Schuhmacherkneifzange**, ca. 200 mm lang

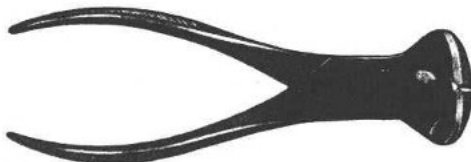

Art. 895 **Vorschneider** für weichen und harten Draht ca. 160 mm lang



Art. 897 **Seitenschneider** für weichen und harten Draht ca. 160 mm lang

Art. 897 K **Derselbe Schneider für Kunststoffe ohne Schneidfacette mit Feder** ca. 160 mm lang

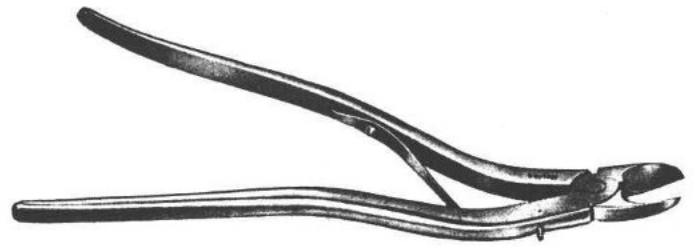

Art. 893 **Manchesterzange**, ca. 32 cm, extra lang für weichen Draht mit festen Backen

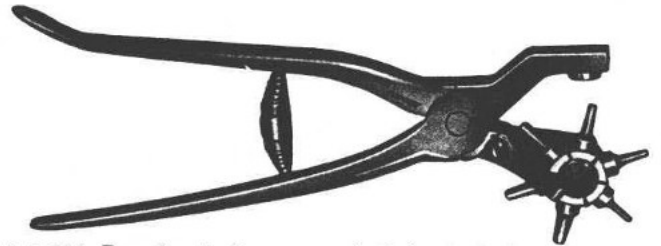

Art. 899 **Revolverlochzange** mit 6 Lochpfeifen, massive Stahlausführung, ca. 20 cm lang

Art. 899 B **Dieselbe Zange**, leichte Ausführung aus gepreßtem Stahlblech



Art. 898 **Täg- und Nagelheber** ca. 170 mm Gesamtlänge



Art. 900 **Klammerzieher**, ca. 170 mm Gesamtlänge



Art. 950 **Henkel-Lochseisen**, solide Ausführung, in allen runden Durchmesser von 2 bis aufwärts 80 mm \varnothing (Bei Bestellung runden Lochdurchmesser angeben)



Original-Packung

Art. 111 **Carborundum-Abziehstein**, bestes und härtestes Schleifmaterial der Welt, für Wasser und Öl zu benutzen. Format 125x50x20 mm

Dieser Stein hat eine feine Seite, also ein feines Korn für Messerwaren mit feiner Schneide, und eine raue Seite zum Schärfen für größere Werkzeuge. Mit Wasser benützt wirkt der Stein hart. Soll der Stein weich wirken, verwende man dünnes, reines Öl. Sollte die Schleiffähigkeit zu groß sein, tauche man den Stein in ein mit heißer Vaseline gefülltes Gefäß, wodurch sich die Poren des Steines füllen. Um den Stein zu reinigen, kann man ihn mit Petroleum abwaschen oder mit heißem Wasser abbrühen.

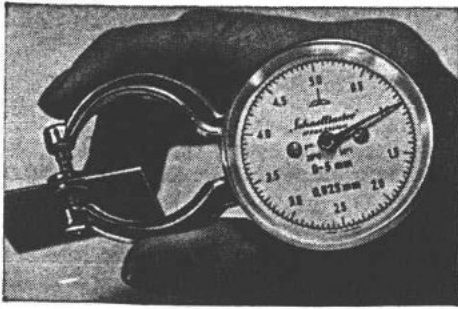

Art. A 01 T **Schnelltaster** zum Messen der Stärke von Rohmaterial 0-5 mm Materialstärke
(auch andere Abmessungen lieferbar)

Verlangen Sie die Schnelltaster-Sonderliste! ▲

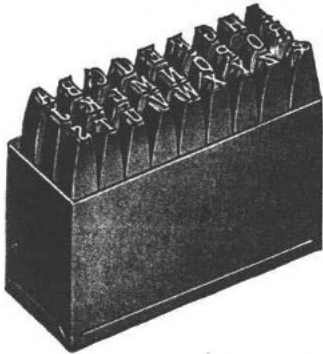

Art. 970
Stahlbuchstaben-Alphabet
Satz 27 Stück, in Schrift-
höhe von 1-15 mm. (Bei Be-
stellung Schriftgröße ange-
ben.)

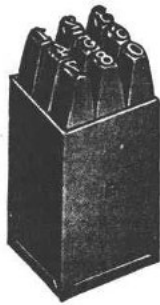

Art. 980
Stahl-Zahlensatz (9 Stück)
in Schriftgröße 1-15 mm
(Bei Bestellung Schriftgröße
angeben.)

Ferner alle Arten **Prägezeichen, Stempel**
nach **Skizze oder Modell-Vorlage**

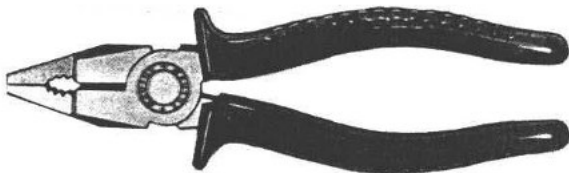

Art. 840 **Kombi-Zange**
in 160 mm Länge
in 190 mm Länge

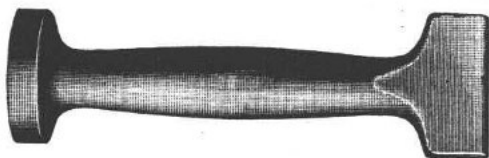

Art. 700 **Bughammer und Nahtverreiber**, mit polierten
Bahnen. Solides und praktisches Werkzeug



Art. 740 **Schuhmacherhammer** mit Stiel aus Stahl-
Material hergestellt, ca. 290 g leichte Ausführung
ca. 350 g mittlere Ausführung
ca. 400 g schwere Ausführung

(Diese Gewichte verstehen sich ohne Hammerstiel.)



Art. 95 H **Entgrathobel** mit Rohrhandgriff, auswechselbar,
zum Entgraten von Gummiastriegen an Gummireifen
und dergleichen, ca. 30 cm Länge

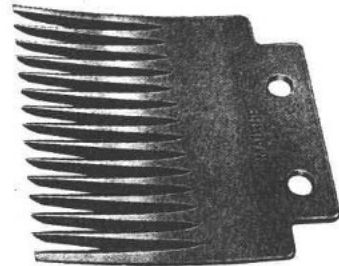

Art. 95 **Entgrathobel Klinge** zum Entgraten von
Gummi-Austriegen, 15 Zähne, auf Wunsch auch
mit 12 Zähnen, ca. 75x75 mm

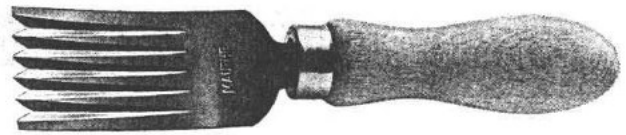

Art. 90 H **Entgrathobel** mit Holzgriff, 6 Zähne,
zum Entgraten von Gummi-Austriegen,
ca. 21 cm Länge



Art. 85 **Entgratmesser** mit Holzgriff, gebogene Klinge,
ca. 105 mm lang, ca. 15 mm breit, 2 mm stark



Art. 75 **Entgratklinge**, 65 mm lang, zum Entgraten von
Gummi und Kunststoffastriegen



Art. 75 **Entgratklinge** zusammen mit
Art. 400 **Metallmesserheft**

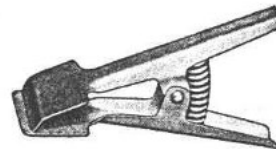

Kräftige vernickelte
Stahlausführung

| | | | |
|-------------|-------|-------|----------|
| Art. | 1900 | 1901 | 1902 |
| Maulweite | 6 cm | 9 cm | 12 cm |
| Maulbreite | 6 cm | 6 cm | 6 1/2 cm |
| Stück-Preis | | | |

Metall-Stoffklammern
zum Festhalten von Materialzuschnitten aller Art

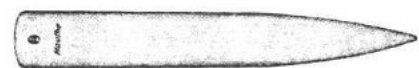

Art. 925 **Falzbeine**, ca. 16 cm lang

Bruttopreisliste

Ausgabe Juni 2015

| <u>Bestell-Nr.</u> | <u>Katalog-Nr.</u> | <u>Artikel</u> | <u>Einzelpreis in €</u> |
|--------------------|--------------------|---|-------------------------|
| 190375 | 75 | Entgratklinge | 4,70 |
| 190375.S | 75 | Entgratklinge, Sondermodell | 3,00 |
| 190372 | 85 | Entgratmesser | 11,69 |
| 190372.S | 85 | Entgratmesser, Sondermodell | 8,80 |
| 190373 | 90 H | Entgrathobel mit Holzheft | 15,75 |
| 190376 | 95 | Entgrathobel 15 Zähne mit zwei Bohrungen | 26,50 |
| 190371 | 95 H | Entgrathobel mit Metallgriff | 40,60 |
| 190371.H | | Griff | 16,00 |
| 190370 | 96 | Entgrathobel 12 Zähne | 12,73 |
| 190301 | 100 | Zuschneidemesser 14/200 | 13,98 |
| 190302 | | Ersatzmesser zu Katalog-Nr. 100 | 6,34 |
| 190303 | 105 | Zuschneidemesser 25/200 | 14,56 |
| 190304 | | Ersatzmesser zu Katalog-Nr. 105 | 6,87 |
| 190308 | 108 | Schuhmachermesser | 6,66 |
| 190309 | | Schuhmachermesser, gebogen | 7,83 |
| 190309L | | | 7,91 |
| 190310 | 110 | Messerhalter | 17,95 |
| 190001 | 111 | Qualitäts-Abziehstein, Öl oder Wasser | 12,94 |
| 190313 | 112 | Schuhmachermesser 22/270 | 16,00 |
| 190314 | 114 | Wiener Schärfmesser | 3,78 |
| 190316 | 156 | Zuschneidemesser 10/300 alternativ: 190325 | zurzeit nicht lieferbar |
| 190317 | 157 | Zuschneidemesser 10/250 | 4,91 |
| 190318 | 118 | Modelliermesser 22/300 | 16,00 |
| 190500 | 170 | Kreismesser | Preis auf Anfrage |
| 190320 | 205 | Zuschneidemesser 125 | 3,35 |
| 190321 | 210 | Zuschneidemesser 6/150 | 2,10 |
| 190325 | 212 SQ | Zuschneidemesser 10/230 | 26,00 |
| 190234 | 280 | Fadenschere, gerade | 11,20 |
| 190235 | | dto. gebogen | 16,62 |
| 190235-B | | Fadenschere | 9,50 |
| 190340 | 360 | Trennmesser, 190 | zurzeit nicht lieferbar |
| 190341 | 361 | Trennmesser, einfache Ausführung | 6,10 |
| 460 | 390 | Zuschneidemesser-Heft (ehem. 190330) | 39,60 |
| 190331 | 395 | Zuschneidemesser-Heft mit Abstechnadel | 23,20 |
| 190331A | | Abstechnadel zu Messerheft Nr. 395 | 6,30 |
| 190332 | 400 | Zuschneidemesser-Heft ohne A. | 16,30 |
| 190333 | | Ersatzzwingen zu Art. 395 u. 400 | 6,30 |
| 190334 | | Zuschneidemesser-Heft mit Abstechnadel | 19,20 |
| 190243 | 453 N | gebogene Schere, spitz/spitz | 31,20 |
| 190241.130 | 528 U | Schere, gebogen | 18,38 |
| 190241.160 | 528 U | Schere, gebogen | 20,40 |
| 190240 | 528 U | Schere, gerade | 17,56 |

| Bestell-Nr. | Katalog-Nr. | Artikel | Einzelpreis in € |
|-------------|-------------|--|----------------------|
| 190290 | 610 | Lederschere | 27,23 |
| 190291 | 611 | Lederschere, gebogen | 39,42 |
| 190292 | 615 | Lederschere mit Feder | 33,98 |
| 190295 | 620 | Materialschere | 23,26 |
| 190295.7 | | Materialschere | 20,96 |
| 190212 | 635 S | Steppereischere 160, aufgebogen | 16,72 |
| 190213 | | Steppereischere 180, aufgebogen | 18,97 |
| 190210 | | Steppereischere, gerade | 16,26 |
| 190201 | 638 | Steppereischere 110 | 8,08 |
| 190202 | | dto. 130 | 8,40 |
| 190203 | | dto. 145 | 16,26 |
| 190204 | | dto. 160 | 11,64 |
| 190206 | 639 | Steppereischere 160 | 17,20 |
| 190207 | | dto. 180 | 13,12 |
| 190208 | | dto. 200 | 13,88 |
| 190230 | 640 | Lochscherer, gerade | 20,10 |
| 190231 | 645 | Lochscherer, gebogen | 19,33 |
| 190270 | 650 | Papierscherer 250 | 14,52 |
| 190260 | 660 | Einringscherer mit Hakenspitze | 17,79 |
| 190261 | 661 | Einringscherer, spitz | 19,30 |
| 190262 | 662 | Einringscherer, aufgebogen | 22,70 |
| 190196 | 700 | Bughammer, vernickelt | 14,24 |
| 190190 | 740 | Schuhmacherhammer 290 g | 16,36 |
| 190191 | | Schuhmacherhammer 350 g | 17,52 |
| 190193 | | Hammerrundkeile zu Nr. 740 | 0,66 |
| 190194 | | Hammerstiele zu Nr. 740 | 2,64 |
| 190160 | 820 | Ia Zwickzange | 30,40 |
| 190161 | 820 SM | dto. mit Magnethammer | 37,18 |
| 190180 | 840 | Kombizange 160 | 9,97 |
| 190182 | | dto. 180 | 10,53 |
| 190171 | 865 | Falzzange, gerades, breites Maul | 23,40 |
| 190172 | 870 | Falzzange, gebogenes, schmales Maul | 23,40 |
| 190173 | 875 | Falzzange, gebogenes, breites Maul | 23,40 |
| 190185 | 880 | Flachzange, 200 | 16,67 |
| 190186 | 880 | Flachzange, 160 | 10,80 |
| 190149 | | Ösenausstoßzange | 34,90 |
| 190150 | 882 | Schuhmacherkneifzange | 15,72 |
| 190152 | 893 | Manchesterzange | 49,22 |
| 190135 | 895 | Kraftvornschneider | 29,80 |
| 190131 | 897 | Seitenschneider | 14,80 |
| 190130 | 897 K | Seitenschneider für Kunststoff, 140 mm | 17,18 |
| 190130 | 897 K | Seitenschneider für Kunststoff, 160 mm | 18,10 |
| 190118 | 898 | Tax- und Nagelheber | 8,26 |
| 190125 | 899 | Revolverlochzange | nicht mehr lieferbar |
| 190120 | 899 B | Revolverlochzange | 11,64 |

| Bestell-Nr. | Katalog-Nr. | Artikel | Einzelpreis in € |
|-------------|-------------|---|-------------------|
| 190126 | 900 | Revolverlochzange, groß, 6 Pfeifen | 55,34 |
| 190136 | 900-8 | Revolverlochzange, groß, <u>8 Pfeifen</u> | 63,16 |
| 190127 | | Ersatzpfeifen, massiv f. 900 + 899 | 3,32 |
| 190126 | | E6. Ersatzpfeifensatz, 6 Stück | 20,24 |
| 190126 | | E8. Ersatzpfeifensatz, 8 Stück | 26,96 |
| 190115 | 900 | Klammerzieher | 3,99 |
| 190110 | 905 | Vorstecher, birnenförmiges Heft, PVC-Heft | 2,56 |
| 190111 | 905 | Vorstecher, durchgehender Stahl | 2,81 |
| 190112 | 905 | Vorstecher, durchgehender Stahl, 1A | 4,58 |
| 190021 | 925 | Falzbein, gerade 160/20 | 2,68 |
| 190020 | 926 | Falzbein, gebogen 180/23 | 4,10 |
| 190019 | | Falzbein, "Banane" 200 | 5,06 |
| 190022 | 950 | Henkel-Locheisen | Preis auf Anfrage |
| | 970 | Schlagbuchstaben | Preis auf Anfrage |
| | 980 | Schlagzahlen | Preis auf Anfrage |
| 190220 | 1160 | Schneiderschere, 8", 200 mm | 28,88 |
| 190221 | | dto. , 9", 230 mm | 32,22 |
| 190222 | | dto. , 10", 250 mm | 38,40 |
| 190223 | | dto. , 12", 300 mm | 52,46 |
| 190224 | 1160 | Schneiderschere links, 8", 200 mm | 39,22 |
| 190226 | | Schneiderschere links, 10", 250 mm | 59,18 |
| 190345 | 1200 | Putzmesser | 4,40 |
| 190350 | 1400 | Gummibeschneidmesser 100 | 8,20 |
| 190351 | 1402 | Gummibeschneidmesser 150 | 11,00 |
| 190352 | | dto. 200 | 13,60 |
| 190353 | | dto. 250 | 21,26 |
| 190354 | 1600 | Gummibeschneidmesser | 25,46 |
| 190280 | 1802 | Zackenschere | 32,45 |
| 190011 | | Metallstoffklammern 170/60 mm | 14,73 |
| 190012 | | dto. 200/65 mm | 16,36 |
| 190101 | | Schnelltaster | Preis auf Anfrage |
| 190014 | | Universalklammer 100/18 mm | 1,60 |
| 190015 | | dto. 150/25 mm | 3,06 |

Die Preise dieser Liste enthalten keine Mehrwertsteuer. Mit dieser Preisliste werden alle früheren ungültig. Für Lieferungen und Zahlungen gelten unsere Verkaufs- und Lieferbedingungen.

C. S. OSBORNE & CO.

Katalog Nr. 59

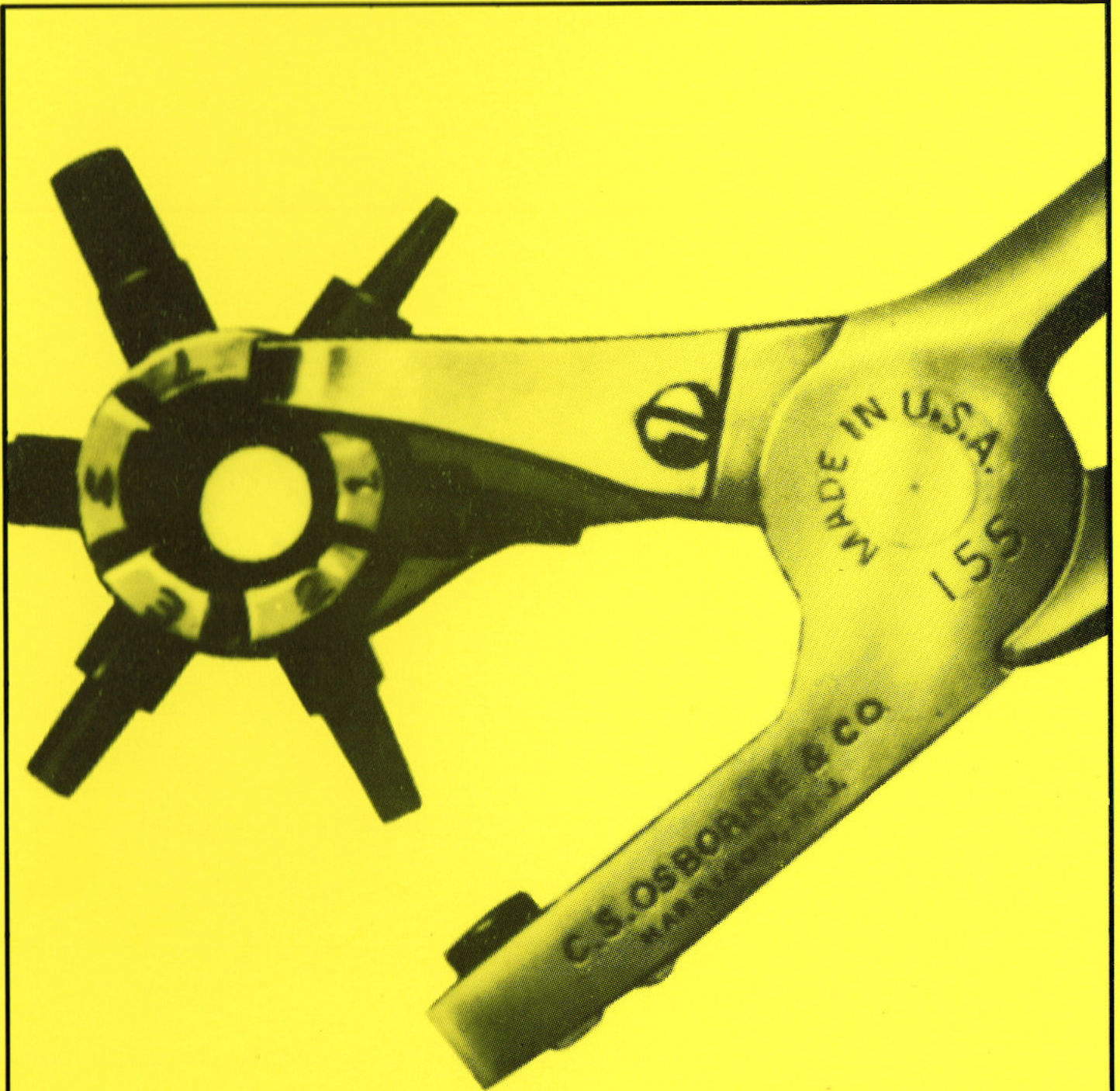

**WERKZEUGE FÜR
LEDER- UND SATTLERARBEITEN**

Inhaltsverzeichnis

| | Seite | | Seite |
|--|-------|-------------------------------|-------|
| Abstoßmesser | 9 | Lederhobel | 11 |
| Ahlen | 20 | Ledermesser | 14 |
| Ahlen mit Heft. | 19 | Lederschärfmesser | 13 |
| Ahlenheft | 9 | Lederschere | 16 |
| Automatische Ahle | 18 | Lederzange | 16 |
| | | Lochahle mit Heft. | 19 |
| | | Lochzange | 1 |
| Dehnungsklingen | 13 | | |
| Druckknopf-Set | 10 | Markierer | 6 |
| | | Modellierer | 8 |
| Entenschnabelzange | 14 | | |
| | | Nadeln | 21 |
| Falkenschnabelmesser | 14 | Nagelheber | 16 |
| Falzbein | 10 | Näh-Hand | 10 |
| Federlochzange | 1 | | |
| Fingerhut | 10 | Ovales Locheisen | 2 |
| Flügelstechzirkel | 5 | | |
| | | Prägeradschlitten | 9 |
| Garnrolle | 18 | Punktierer | 9 |
| Gurtlocheisen | 4 | Punzengriffel | 8 |
| Gurtlocheisen-Set | 4 | | |
| | | Reifelholz | 6 |
| Halbmondmesser | 12 | Reißzirkel | 5 |
| Heftklammernentferner | 16 | Revolver-Lochzange | 1 |
| Henkellocheisen | 4 | Riemen-Endeisen | 2 |
| Hohlmeißel | 6 | Rohhauthammer | 3 |
| | | Rundlocheisen | 1 |
| | | | |
| Kantenbieger | 6 | Sattlerhammer | 15 |
| Kantenschräger | 8 | Schneidmesser für Leder | 12 |
| Kantenzieher | 7 | Schneidunterlage | 3 |
| Kantenheber | 9 | Schusterhammer | 15 |
| Kappenlocheisen | 2 | Spaltmaschine | 11 |
| Klingenheft | 13 | Spitzknochen | 10 |
| Kombinierte Zwick- und Hammerzange | 15 | | |
| Kopfmesser | 12 | Ziehmesser | 5 |
| | | Zirkel | 5 |

Inhaltsverzeichnis

| Art. | Seite | Art. | Seite | Art. | Seite |
|---------|-------|-------|-------|-------|-------|
| 0150 | 2 | 155 | 1 | 701 | 8 |
| 4 | 17 | 158 | 2 | 702 | 8 |
| 8 | 19 | 196-4 | 3 | 704 | 8 |
| 8-B | 19 | 200 | 16 | 708 | 16 |
| 18 | 19 | 202 | 16 | 925 | 11 |
| 20-C | 6 | 227 | 15 | DB 1 | 14 |
| 21 | 6 | 230 | 10 | K-157 | 3 |
| 34 | 5 | 233 | 15 | K-245 | 4 |
| 38-C | 5 | 245 | 4 | T-11 | 19 |
| 51 | 5 | 250 | 16 | | |
| 55 | 15 | 259 | 13 | | |
| 66 | 15 | 266 | 10 | | |
| 70 | 12 | 395 | 3 | | |
| 71 | 12 | 413 | 18 | | |
| 72 | 14 | 425 | 14 | | |
| 73 | 12 | 444 | 6 | | |
| 77 | 14 | 446 | 6 | | |
| 79,5 | 14 | 447 | 9 | | |
| 86 | 11 | 448-1 | 9 | | |
| 93 | 15 | 454 | 8 | | |
| 106 | 5 | 457 | 9 | | |
| 120,5 | 16 | 458 | 8 | | |
| 122 | 16 | 459 | 9 | | |
| 125 | 7 | 460 | 13 | | |
| 126 | 7 | 464 | 10 | | |
| 127 | 7 | 465 | 10 | | |
| 127,5 | 7 | 467 | 8 | | |
| 127,5-S | 7 | 469 | 13 | | |
| 128 | 6 | 471 | 8 | | |
| 130-4 | 7 | 472 | 8 | | |
| 133-B | 7 | 473 | 8 | | |
| 133-S | 7 | 474 | 8 | | |
| 143-2 | 20 | 475 | 8 | | |
| 144 | 20 | 476 | 8 | | |
| 145 | 20 | 478 | 19 | | |
| 147 | 1 | 479 | 13 | | |
| 149 | 4 | 485 | 6 | | |
| 150 | 2 | 510 | 10 | | |
| 151 | 2 | 511 | 10 | | |
| 153 | 1 | 603 | 3 | | |

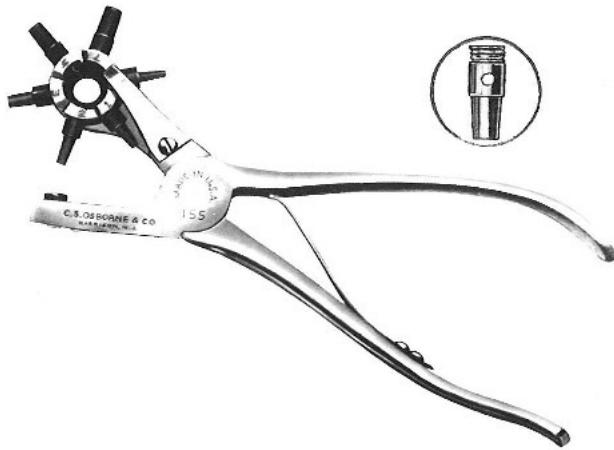

OSBORNE Nr. 155 REVOLVER-LOCHZANGE

Für den professionellen und industriellen Gebrauch mit 6 auswechselbaren Pfeifen 0, 1, 2, 3, 5, 7. Die Zange ist aus geschmiedetem Stahl, hochglänzend poliert. Die schneidenden Pfeifen sind handgedreht aus speziellem Karbonwerkzeugstahl und gehärtet. Die Pfeifen sind leicht auszuwechseln, einzeln gehärtet.
Länge der Zange: 21,5 cm.

| | | | | | | |
|--------|-----|-----|-----|-----|-----|-----|
| Größen | 0 | 1 | 2 | 3 | 5 | 7 |
| mm | 2,0 | 2,4 | 2,8 | 3,2 | 4,4 | 5,2 |

- Nr. 155-A Ersatzamboß für Nr. 155
- Nr. 155-HS Ersatzfeder für Nr. 155
- Nr. 155 T(Nr.) Ersatzpfeifen für Nr. 155
- Nr. 155-SP Ersatzradfeder für Nr. 155

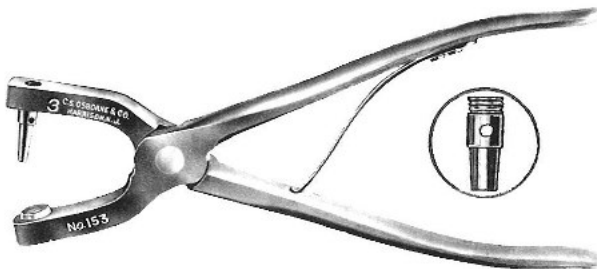

OSBORNE Nr. 153 FEDERZANGE

Für den professionellen und industriellen Gebrauch. Geschmiedete Stahlzange, hochglänzend poliert. Für austauschbare, handgedrehte Pfeifen. Distanz von der schneidenden Pfeife zum Backen 3,8 cm, in den Größen 000 bis 10.

ACHTUNG: Drei verschiedene Zangenrahmen: Pfeifen 000 bis 7 passen in denselben Rahmen und sind austauschbar. Pfeife Größe 8 paßt nur in Rahmen Nr. 8, Pfeifen 9 und 10 passen in den größten Rahmen und sind austauschbar.

- Nr. 153-A Ersatzamboß für Nr. 153
- Nr. 153-HS Ersatzfeder für Nr. 153
- Nr. 153 T(Nr.) Ersatzpfeifen für Nr. 153

Pfeifengrößen für Nr. 153

| | | | | | | | | | | | | | |
|------------------------|-----|-----|-----|-----|-----|-----|-----|-----|-----|-----|-----|-----|-----|
| Pfeifengr. für Nr. 153 | o | o | o | o | o | o | o | o | o | o | o | o | o |
| Größe Nr. | 000 | 00 | 0 | 1 | 2 | 3 | 4 | 5 | 6 | 7 | 8 | 9 | 10 |
| ca. mm | 1,2 | 1,6 | 2,0 | 2,4 | 2,8 | 3,2 | 4,0 | 4,4 | 4,8 | 5,2 | 6,3 | 7,1 | 7,8 |



OSBORNE Nr. 147 RUND-LOCHEISEN

Aus Werkzeugstahl geschmiedet, mit polierter Pfeife. Das Loch verjüngt sich von der Schneidekante, so daß sich die Eisen nicht lösen.

| | | | | | | | | | | | | | | | | | |
|-----------|-----|-----|-----|-----|-----|-----|-----|-----|-----|-----|-----|-----|------|------|------|------|------|
| Größe Nr. | 0 | 1 | 2 | 3 | 4 | 5 | 6 | 7 | 8 | 9 | 10 | 11 | 12 | 13 | 14 | 15 | 16 |
| mm | 2,0 | 2,8 | 3,2 | 3,6 | 4,0 | 4,4 | 4,8 | 5,6 | 6,3 | 7,1 | 7,9 | 9,5 | 10,3 | 11,1 | 11,9 | 13,1 | 14,3 |

OSBORNE Nr. 150 RIEMEN-ENDEISEN RUND
Gehärtete und polierte Schneide.

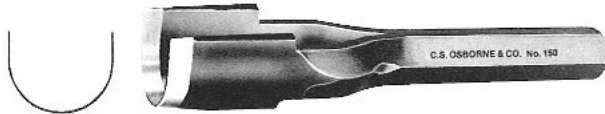

| Größe | mm | Zoll |
|-------|------|------|
| 1 | 6,4 | 1/4 |
| 2 | 9,5 | 3/8 |
| 3 | 12,7 | 1/2 |
| 4 | 15,4 | 5/8 |
| 5 | 19,0 | 3/4 |
| 6 | 22,2 | 7/8 |
| 7 | 25,4 | 1 |

| Größe | mm | Zoll |
|-------|------|-------|
| 8 | 28,6 | 1-1/8 |
| 9 | 31,8 | 1-1/4 |
| 10 | 35,0 | 1-3/8 |
| 11 | 38,1 | 1-1/2 |
| 12 | 41,3 | 1-5/8 |
| 13 | 44,5 | 1-3/4 |
| 14 | 51,0 | 2 |

OSBORNE Nr. 0150 RIEMEN-ENDEISEN SPITZ
Gehärtete und polierte Schneide.

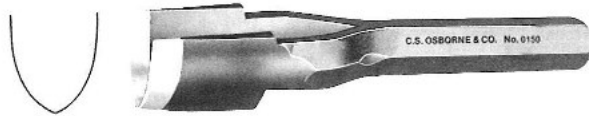

Größen siehe Nr. 150.

OSBORNE Nr. 151 KAPPENLOCHEISEN

Spitz zulaufender Innenraum. Polierter Griff, gehärtete und polierte Pfeife.



| Nr. | Länge mm | Weite mm | Länge Zoll | Weite Zoll |
|-----|----------|----------|------------|------------|
| 1 | 6,4 | 2,0 | 1/4 | 5/64 |
| 2 | 9,5 | 2,4 | 3/8 | 3/32 |
| 3 | 12,7 | 2,8 | 1/2 | 7/64 |
| 4 | 15,9 | 3,2 | 5/8 | 1/8 |
| 5 | 19,0 | 3,6 | 3/4 | 9/64 |
| 6 | 22,2 | 4,0 | 7/8 | 5/32 |
| 7 | 25,4 | 4,0 | 1 | 5/32 |
| 8 | 28,6 | 4,4 | 1-1/8 | 11/64 |
| 9 | 31,8 | 4,4 | 1-1/4 | 11/64 |
| 10 | 34,9 | 4,8 | 1-3/8 | 3/16 |
| 11 | 38,1 | 5,2 | 1-1/2 | 13/64 |
| 12 | 41,3 | 5,6 | 1-5/8 | 7/32 |
| 13 | 44,5 | 5,6 | 1-3/4 | 7/32 |
| 14 | 47,6 | 6,4 | 1-7/8 | 1/4 |
| 15 | 50,8 | 6,4 | 2 | 1/4 |

OSBORNE Nr. 158 OVALES LOCHEISEN

Aus qualitativ bestem Werkzeugstahl gefertigt, sorgfältig gehärtet, mit polierter Pfeife. Das Loch verjüngt sich von der Schneidekante, so daß sich die Stanzen leicht lösen. Polierter Griff, Größe 1 bis 16.

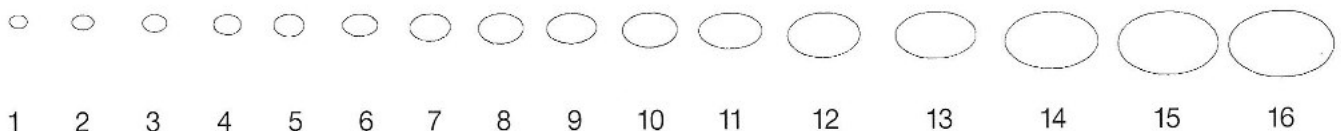

1 2 3 4 5 6 7 8 9 10 11 12 13 14 15 16

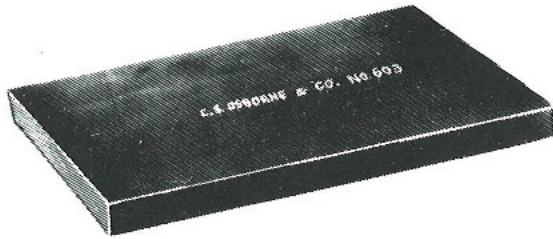

OSBORNE Nr. 603 SCHNEIDUNTERLAGE

Aus elastischem Vinyl, ideal für Lochstanzen. Lange Lebensdauer, beidseitig verwendbar.
Größe 254 mm x 245 mm x 13 mm.

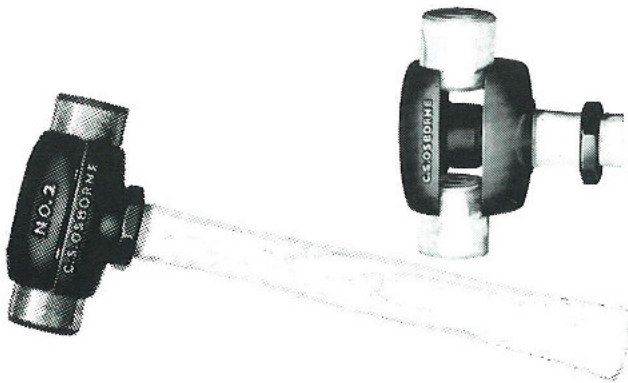

OSBORNE Nr. 395 ROHHAUT-HAMMER

Ideal für den Gebrauch der Locheisen und wo immer ein gedämpfter Schlag erwünscht ist. Leicht auswechselbare Köpfe aus gerolltem Rohleder, massiv und lange Lebensdauer.

| Größe | Kopflänge | Durchmesser |
|-------|-----------|-------------|
| 1 | 9,2 cm | 3,2 cm |
| 2 | 10,7 cm | 3,8 cm |
| 3 | 12,4 cm | 4,5 cm |



OSBORNE Nr. 196-4 ROHHAUT-HAMMER

Der Kopf dieses leichtgewichtigen Hammers besteht aus sorgfältig gerolltem Rohleder. Amerikanischer Hickory-Holzstiel. Ideal zum Bearbeiten empfindlicher Werkstücke.

| Kopfdurchmesser | Kopflänge | Stiellänge | Gewicht |
|-----------------|-----------|------------|---------|
| 50 mm | 8,75 cm | 25 cm | 340 g |

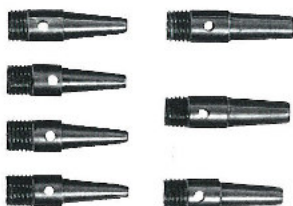

OSBORNE K-157 KLEINES LOCHEISENSET

Ein spezielles Locheisen für das Stanzen von kleinen, präzisen Löchern in weiches Material, das mit normalen Locheisen nicht möglich ist. Das Set besteht aus einem runden Griff mit einem Schlitz zum Säubern. Der Griff ist so gearbeitet, daß er passend ist für sieben auswechselbare Schraubzylinder in den Größen wie unten angegeben.

| Nr. | 0 | 1 | 2 | 3 | 4 | 5 | 6 |
|--------|-----|-----|-----|-----|-----|-----|-----|
| ca. mm | 2,0 | 2,4 | 2,8 | 3,2 | 4,0 | 4,4 | 4,8 |

Nr. 153 T(Nr.) Ersatzpfeifen für Nr. K-157.



OSBORNE Nr. 149 HENKELLOCHEISEN

Geschmiedet aus einem ganzen Stück hochwertigen Stahls. Die Schneidenden sind einem besonders aufwendigen Härteverfahren unterzogen worden.

Lieferbar in folgenden Größen

| Durchmesser | auf Lager (sofort lieferbar) | Durchmesser | auf Lager (sofort lieferbar) | Durchmesser | auf Lager (sofort lieferbar) | Durchmesser | auf Lager (sofort lieferbar) |
|-------------|---------------------------------|-------------|---------------------------------|-------------|---------------------------------|-------------|---------------------------------|
| 4 | | 16 | x | 28 | | 40 | |
| 5 | | 17 | | 29 | | 41 | |
| 6 | x | 18 | x | 30 | x | 42 | |
| 7 | x | 19 | | 31 | | 43 | |
| 8 | x | 20 | x | 32 | | 44 | |
| 9 | | 21 | | 33 | | 45 | |
| 10 | x | 22 | x | 34 | | 46 | |
| 11 | x | 23 | | 35 | | 47 | |
| 12 | x | 24 | | 36 | | 48 | |
| 13 | | 25 | x | 37 | | 49 | |
| 14 | | 26 | | 38 | | 50 | |
| 15 | x | 27 | | 39 | | 51 | |
| | | | | | | 52 | |



OSBORNE Nr. K-245 GURTLOCHEISEN-SET

Das Set enthält sechs Gurtlocheisen in den gängigsten Größen.

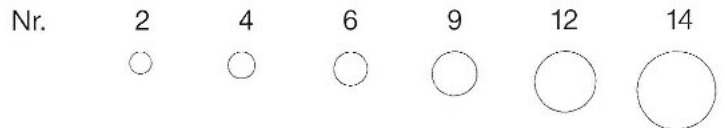

OSBORNE Nr. 245 GURTLOCHEISEN

Runder Bolzen, polierter Griff.

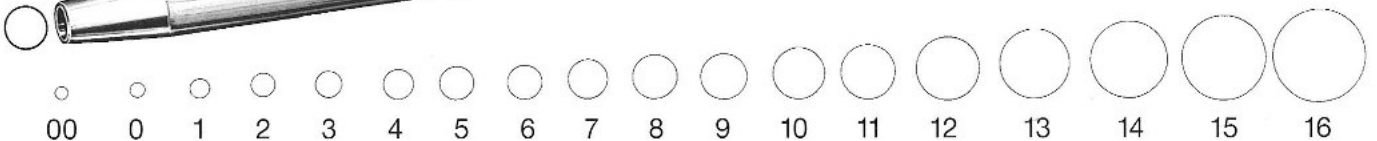

| Größe Nr. | 00 | 0 | 1 | 2 | 3 | 4 | 5 | 6 | 7 | 8 | 9 | 10 | 11 | 12 | 13 | 14 | 15 | 16 |
|-----------|------|------|------|-----|------|------|-------|------|-------|------|-----|-------|------|------|-------|-----|-------|------|
| ∅ mm | 1,6 | 2,0 | 2,3 | 3,1 | 3,5 | 3,9 | 4,3 | 4,7 | 5,1 | 5,5 | 6,2 | 6,6 | 7,0 | 7,8 | 8,6 | 9,4 | 10,2 | 10,9 |
| ∅ Zoll | 1/16 | 5/64 | 3/32 | 1/8 | 9/64 | 5/32 | 11/64 | 3/16 | 13/64 | 7/32 | 1/4 | 17/64 | 9/32 | 5/16 | 11/32 | 3/8 | 13/32 | 7/16 |

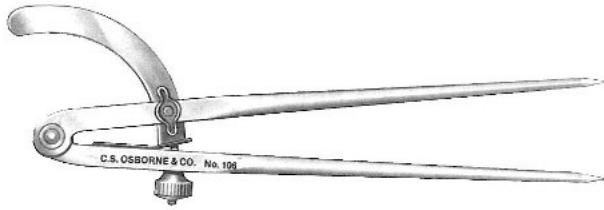

OSBORNE Nr. 106 FLÜGELSTECHZIRKEL

Die Spitzen sind sorgfältig gehärtet, die Schraubgewinde mit größter Sorgfalt eingedreht, um einen perfekten Sitz zu garantieren. Die Federn sind speziell gehärtet, so daß der Zirkel leicht eingestellt werden kann. Schraubmutter aus Stahl, Unterlegscheiben aus Messing.

| | | | | |
|-------------|----|----|----|----|
| Größe in cm | 15 | 20 | 25 | 30 |
|-------------|----|----|----|----|

- Nr. 106-B Ersatzblatt 15 cm
- Nr. 106-BM Ersatzblatt 20 cm
- Nr. 106-BL Ersatzblatt 25/30 cm
- Nr. 106-S Ersatzflügelschraube
- Nr. 106-KN Ersatzschraube
- Nr. 106-SP Ersatzfeder

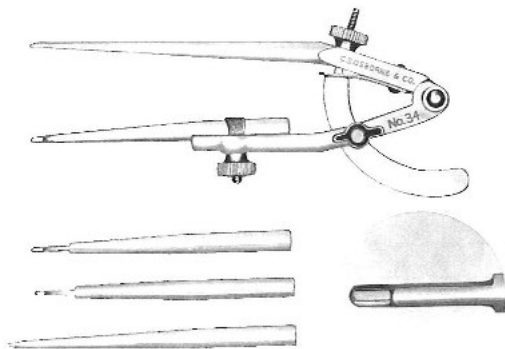

OSBORNE Nr. 34 REISSZIRKEL

Vielfältig verwendbarer, polierter Reißzirkel. Eine Spitze und drei Schneider: klein, mittel, groß. Zum Ritzten von Kreisen, dekorativen Mustern oder zum Ausmeißeln von Nähkanten.

Auswechselbare Spitzen:
34-1 klein; 34-2 mittel; 34-3 groß; 34-P spitz



OSBORNE Nr. 38-C REISSZIRKEL ENGLISCH

Dieser Reißzirkel englischer Art ermöglicht ein leichtes Ausmeißeln mit Hilfe seines geschliffenen Schneidendes.

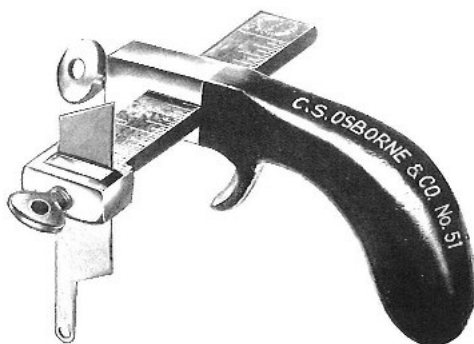

OSBORNE Nr. 51 ZIEHMESSER

Zum Schneiden von Lederstreifen. Gesamtes Werkzeug aus Metall mit poliertem Kopf, Meßschieber und Blatt. Emaillierter Aluminiumgriff. Schneidet Streifen jeden Leders bis zu einer Breite von 10 cm.

- Nr. 51-B Blatt für Ziehmesser
- Nr. 51-G-S Bolzen für Ziehmesser (klein)
- Nr. 51-G-L Bolzen für Ziehmesser (groß)
- Nr. 51-R Meßschieber für Ziehmesser
- Nr. 51-TS Daumenschraube für Ziehmesser (groß)
- Nr. 51-TSS Daumenschraube für Ziehmesser (klein)



OSBORNE Nr. 128 REGULIERBARER HOHLMEIßEL

Ausgezeichnetes Werkzeug zum Ausmeißeln von Falten, leichte Anpassung des Meißels durch ein regulierbares Schraubgewinde an jede Tiefe. Die Größen Nr. 1, 2, 3 besitzen ein U-förmiges Hohleisen. Das 90-Grad- oder V-Form- (Größe Nr. 4) Hohleisen wird bei Notizbüchern, Koffern, Handtaschen und überall, wo ein scharfer, rechtwinkliger Falz erwünscht ist, gebraucht.

| | | | | |
|--------------|------|-----|------|---------|
| Größe Nr. | 1 | 2 | 3 | 4 |
| Weite (mm) | 2,4 | 3,2 | 4,0 | 90 Grad |
| Weite (Zoll) | 3/32 | 1/8 | 5/32 | |



OSBORNE Nr. 21 KANTENBIEGER

Einzelner Kantenbieger, Hartholzgriff, Größen 1, 2, 3, 4, 5. Vergrößert Kanten. Die lange Werkzeugseite an der Lederkante als Führung anlegen und mit der kurzen Seite prägen. Vorm Vergrößern Kanten mit Kantenwerkzeug abrunden.

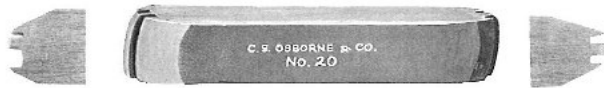

OSBORNE Nr. 20-C REIFELHOLZ

Extrem hartes Bethabaraholz, macht Falten in vier Größen, zwei Kanten an jedem Ende. Den Mittelpunkt als Kantenführung benutzen und mit äußerer Kante prägen.

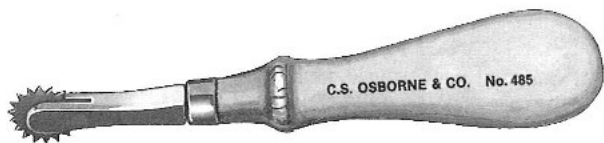

OSBORNE Nr. 485 MARKIERER

In den Größen 5, 6 und 7 (entspricht Anzahl der Markierungen je 2,5 cm).



OSBORNE Nr. 444/446 DREHBARER STOSSBEITEL

444 Beitel ist mit dem mittleren Blatt OSBORNE Nr. 2 ausgestattet, verchromt, gehärtete Werkzeugstahlklinge.

446 regulierbarer Beitel, ausgestattet mit drei gehärteten Werkzeugstahlklingen: OSBORNE Nr. 1, OSBORNE Nr. 2, OSBORNE Nr. 3. Die Länge des Beitel kann mit einer Haltnut justiert werden, so daß er in jede Hand paßt. Das bedeutendste Werkzeug bei der Lederarbeit erlaubt präzise Schnitte für schnelle und schwierige Designlinien.

Nr. 446-B-1 bis B-3 ERSATZKLINGEN für Nr. 444/446.



OSBORNE Nr. 125 ALLGEM. KANTENZIEHER

Zum leichten Abrunden und Abschrägen von Riemenrändern und weichem Leder, Hartholzgriff.

| | | | | | | | |
|------------|-----|-----|-----|-----|-----|-----|-----|
| Größe | 00 | 0 | 1 | 2 | 3 | 4 | 5 |
| Weite (mm) | 2,4 | 3,2 | 3,6 | 4,0 | 4,8 | 5,2 | 5,6 |



OSBORNE Nr. 127 KANTENZIEHER

Ideal zum Abrunden von Ledersäumen, auch bei sehr feinem Leder. Die kleineren Nummern sind für feines, die größeren für gröberes Leder. Perfekt zum Vertiefen von Falten in weichem Leder oder zum Beschneiden eines überstehenden Rollsaums.

| | | | | |
|------------|-----|-----|-----|-----|
| Größe | 1 | 2 | 3 | 4 |
| Weite (mm) | 1,2 | 1,6 | 2,0 | 2,4 |



OSBORNE Nr. 126 FEINER KANTENZIEHER

Aus qualitativ bestem Stahl geschmiedet.

| | | | | | | | |
|------------|-----|-----|-----|-----|-----|-----|-----|
| Größe | 0 | 1 | 2 | 3 | 4 | 5 | 6 |
| Weite (mm) | 1,6 | 2,4 | 3,2 | 4,0 | 4,8 | 5,6 | 6,4 |



OSBORNE Nr. 130-4 FRANZ. KANTENZIEHER

Aus speziellem Stahl in traditioneller OSBORNE-Qualität geschmiedet. Dieses vollendete Präzisionswerkzeug, Größe 6,35 mm, ist für den Profi. Es eignet sich zum Abschrägen von Kanten in jedem gewünschten Winkel, eingeschlossen Gehfugen, es vertieft, furcht und spaltet. Nicht zum Abrunden von Kanten, da Unterseite flach.



OSBORNE Nr. 127.5-S BISSONNETTE-KANTENZIEHER

Geschliffener, scharfer Innenrand des Loches zur ziehenden Kantenbearbeitung. Schnelles Abschrägen der Kante. Gerader Schaft.

| | | | | | |
|------------|-----|-----|-----|-----|-----|
| Größe | 0 | 1 | 2 | 3 | 4 |
| Weite (mm) | 2,0 | 2,4 | 2,8 | 3,6 | 4,4 |



OSBORNE Nr. 127.5-B BISSONNETTE-KANTENZ.

Gebogener Schaft.
Größen siehe 127.5-S.



OSBORNE 133-S KANTENZIEHER

Mit nach oben gebogener Spitze, bestens geeignet für Sattler und gleichartige Arbeit.

| | | | | | |
|------------|-----|-----|-----|-----|-----|
| Größe | 0 | 1 | 2 | 3 | 4 |
| Weite (mm) | 0,8 | 1,2 | 1,6 | 2,8 | 3,6 |



OSBORNE Nr. 133-B KANTENZIEHER

Gebogener Schaft.
Größen siehe 133-S.

OSBORNE-MODELLIERER

Alle OSBORNE-Modellierer sind aus rostfreiem Stahl, der Gummigriff erlaubt ein einfaches Arbeiten.



OSBORNE Nr. 471

Der beste Modellierer für normale Arbeiten. Ein Ende ist eng und spitz, geeignet für Linien oder Risse, das andere Ende ist abgeflacht, passend für jede Modellierarbeit.



OSBORNE Nr. 458

Ein Ende ist ausgestattet mit einem kleinen „Hirschfuß“ zum Beschriften oder Erreichen kleinerer Stellen. Das andere Ende kann als Kantenbieger oder für doppelte Grenzlinien benutzt werden.



OSBORNE Nr. 454

Diamantspitzen-Löffelende und feines Spurspitzenende. Spezielles Design.



OSBORNE Nr. 472

Flach an beiden Enden. Ausgezeichnet zum Modellieren derber Oberflächen.



OSBORNE Nr. 473

„Hirschfuß“, zum Abschrägen und Eindrücken von Außenkanten, für Feinarbeit etc.



OSBORNE Nr. 474

Punzen zum Zeichnen von Mustern in Leder.

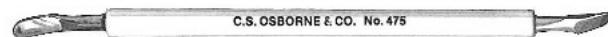

OSBORNE Nr. 475

Gutes Allgemeinwerkzeug, ausgezeichnet für gerade Linienarbeit.

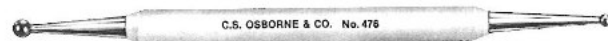

OSBORNE Nr. 476

Kugelenden-Modellierer zum Prägen.

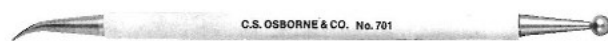

OSBORNE Nr. 701

Kombinierter Modellierer mit gebogener Spitze und Kugelende.



OSBORNE Nr. 702

„Hirschfuß“ und gebogene Spitze.



OSBORNE Nr. 704 PUNZENGRIFFEL

Kugelspitze, verchromt.

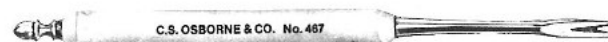

OSBORNE Nr. 467 KANTEN-SCHRÄGER

Zum Abschrägen von Kanten leichten Leders zur Vorbeugung von Ausfransung.



OSBORNE Nr. 459 PRÄGERADSCHLITTEN

Handprägeradschlitten für auswechselbare, hier dargestellte Räder. Besonders für Zierleisten. Kann erhitzt werden, damit das Muster ins Leder eingebraunt wird. Der Schlitten hat eine Flügelschraube, so daß die Prägeräder leicht ausgewechselt werden können.

Nr. 459-6 bis 459-19.

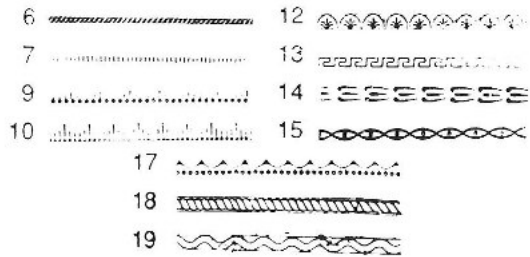

OSBORNE Nr. 447 ABSTOSSMESSER

Zur Bearbeitung nach dem Schneiden.



OSBORNE Nr. 448-1 DESIGN-KANTENHEBER

Zum Anheben geschnittener Flächen.



OSBORNE Nr. 457 PUNKTIERER

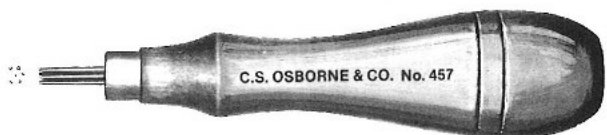



OSBORNE Nr. 510 FINGERHUT, GEÖFFNET
Messing.

| | | | | |
|--------|----|------|------|------|
| Größen | 00 | 0 | 1 | 2 |
| mm | 2 | 1,95 | 1,87 | 1,80 |

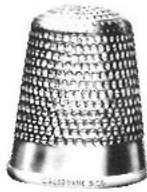

OSBORNE Nr. 511 FINGERHUT
Messing.

| | | | | |
|--------|----|------|------|------|
| Größen | 00 | 0 | 1 | 2 |
| mm | 2 | 1,95 | 1,87 | 1,80 |



OSBORNE Nr. 266 NÄH-HAND

Handschutz mit hartem Rohlederaufsatz, so daß Finger beim Nähen nicht verletzt werden. Vernietete Naht. Sowohl für Rechts- als auch Linkshänder lieferbar.

| | |
|-----------|-----------|
| rechts | links |
| Nr. 266-R | Nr. 266-L |

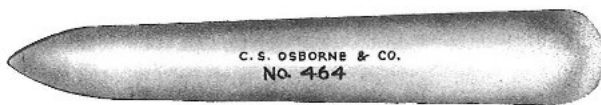

OSBORNE Nr. 464 SPITZKNOCHEN/FALZBEIN

Hochglänzender, echter Spitzknochen zum Kleben und Falzen. Auch zum Brünieren von Latratoneblechplatten, Beschriftungen usw.

OSBORNE Nr. 465

Ebenso wie Nr. 464, nur aus synthetischem Material.

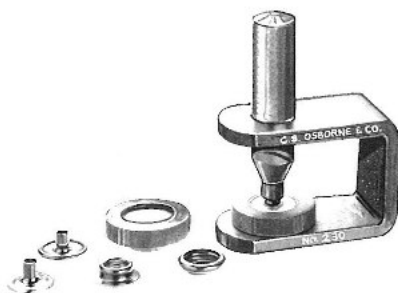

OSBORNE Nr. 230 DRUCKKNOPF-SET

Einfach zu benutzendes Druckknopf-Handset, verchromte Knöpfe.

OSBORNE Nr. 230-S DRUCKKNÖPFE

100 verchromte Druckknopfsätze, vierfach.

OSBORNE Nr. 86 SCHNEIDEMASCHINE

Diese solide Schneidemaschine ist die meistverkaufte, professionelle auf dem Markt. Sie hat einen robusten, gußeisernen Rahmen und ein hohlgeschliffenes 152-mm-Blatt. Einfach einstellbare Vorrichtung, um Leder jeder Dicke zu schneiden. Anweisung anbei.

Nr. 86-B ERSATZMESSER

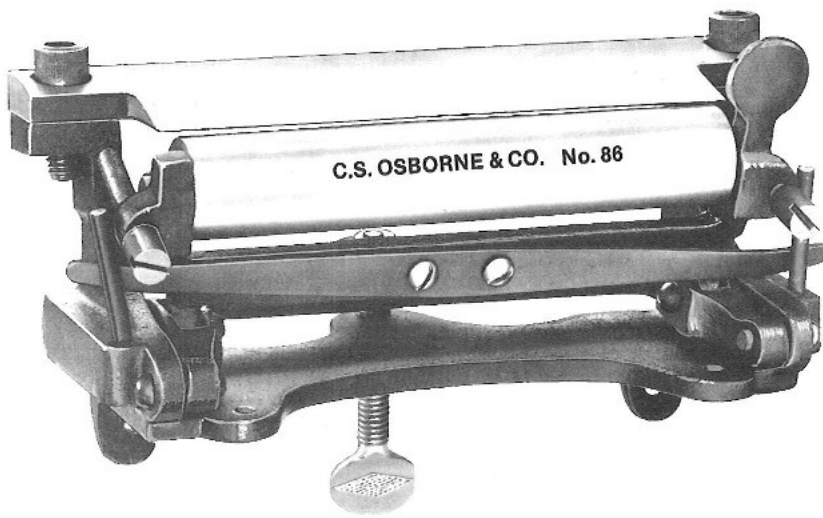

OSBORNE Nr. 925 LEDERHOBEL

Unentbehrlich beim Ausschälen von zu dickem Material wie z. B. Lederrücken beim Biegen und Falten. Klinge ist auswechselbar.

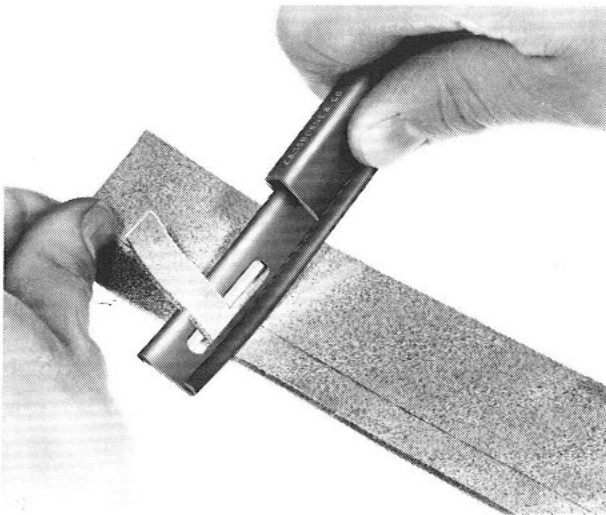

OSBORNE Nr. 925-100 ERSATZKLINGEN
100 Ersatzklingen, lose verpackt.

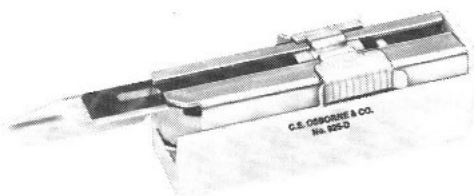

OSBORNE Nr. 925-D ERSATZKLINGEN IM SPENDER
20 Klingen in einem Spender.

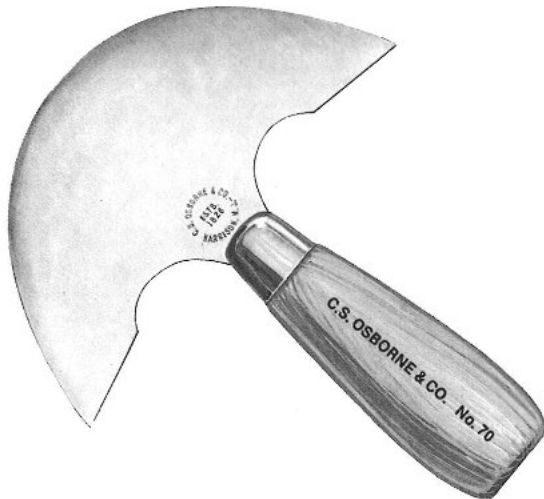
**OSBORNE Nr. 70 HALBMONDMESSER**

Geschmiedetes Stahlblatt von höchster Qualität, 127 mm breit. Ovaler, lackierter Hartholzgriff, Messingzwinge.

**OSBORNE Nr. 71 KOPFMESSER**

Speziell für Lederarbeit. Blattgröße 114 mm von Spitze zu Spitze. Messingzwinge, runder Hartholzgriff.

Länge 6 cm.

**OSBORNE Nr. 73 SCHNEIDMESSER FÜR LEDER**

Dieses Messer wird gebraucht bei Arbeiten mit Leder und Buntglas. Hartholzgriff.

OSBORNE Nr. 469 LEDERSCHÄRFMESSER

Extra-Qualität, zum Lederspaltten, überzogene Zwinge.

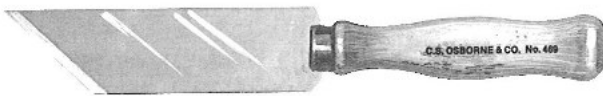

OSBORNE Nr. 479 SCHRÄGES SPALTMESSER

Zum Spalten und Kantentrimmen von Leder und ähnlichem Materialien. Überzogene Zwinge, lackierter Holzgriff.



Länge 7,6 cm.

OSBORNE Nr. 460 KLINGENHEFT

Für austauschbare Dehnungsklingen.



OSBORNE Nr. 259 DEHNUNGSKLINGEN

Für Nr. 460.

Sorgfältig geschliffene und gehärtete Klingen zum Schneiden von Leder und ähnlichem Material, 12 cm lang.

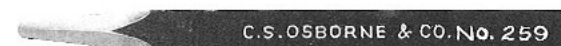

- Nr. 259-B abgeschrägt
- Nr. 259-S spitz
- Nr. 259-L gerade
- Nr. 259-C gekrümmt

**OSBORNE Nr. 79.5 SPITZES MESSER**

Lackierter Hartholzgriff, populäres Ziermesser in der Schuh- und Lederindustrie.

Länge 9,5 cm, Blattgröße 1,9 cm.

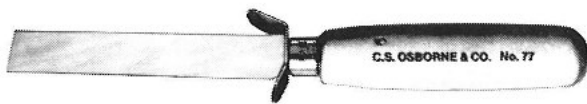
**OSBORNE Nr. 77 POLSTERMESSER**

Traditionelles Messer mit Holzheft, die verankerte Klinge ist 17 mm breit und 100 mm lang. Da mit diesem Messer häufig Arbeiten ausgeführt werden müssen, die schnell zu einem Abrutschen der Hand führen, haben wir eine Schutzvorrichtung am Schaftanfang konstruiert. Damit werden wir den wachsenden Sicherheitsanforderungen gerecht.

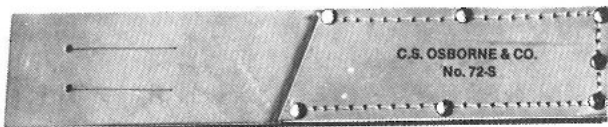
**OSBORNE Nr. 72 SICHERHEITSSCHEIDE**

Eine lederne Sicherheitsscheide für OSBORNE-Messer. Kann am Gürtel befestigt werden. Enden sind mit 6 Ösen speziell verstärkt worden.

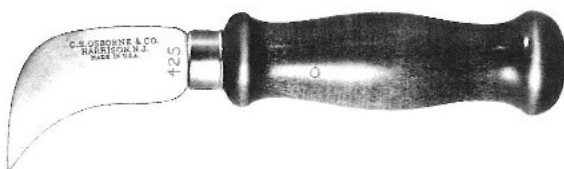
**OSBORNE Nr. 425 FALKENSCHNABELMESSER**

Kurzes Blatt im griffigen Holzgriff verankert.

Blattlänge 6,3 cm.

**OSBORNE Nr. DB1 ENTENSCHNABELZANGE**

Aus Schmiedeeisen, Klemmbacken extraweit. Speziell kleine Fingerkrümmung, vernickelt, populärer Stil.

Gesamtlänge 177 mm.



OSBORNE Nr. 55 SATTLERHAMMER

Französischer Sattlerhammer, ovaler Walnußholzgriff mit Stielschaft vernietet. Kopf und Griff sind aus Stahl in einem Stück geschmiedet, hochglänzend. Das glatte, stumpfe Ende ist ideal zum Formen des Leders und Einschlagen von Stiften an unzugänglichen Stellen.

Länge des Kopfes 17,14 cm.
Durchmesser der Stirnfläche 1,6 cm.

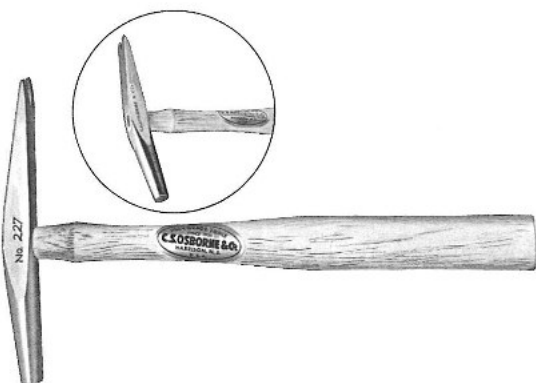

OSBORNE Nr. 227 SATTLERHAMMER

Gehärteter Stahl, poliert. Wird von Sattlern und bei der Kofferherstellung gebraucht.

Kopflänge 165 mm.
Durchmesser der Stirnfläche 11 mm.



OSBORNE Nr. 66 SCHUSTERHAMMER

Der populäre Standardhammer aus geschmiedetem Stahl, poliert. Unerläßliches Werkzeug in der Lederarbeit.

Gesamtlänge 23,5 cm.
Kopflänge 8,2 cm.
Durchmesser 3,4 cm.

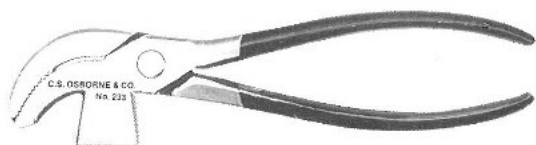

OSBORNE Nr. 233 KOMBINIERTE ZWICK- UND HAMMERZANGE

Geschmiedet, sorgfältig geprägte Zähne. Polierter Kopf, schwarzlackierte Griffe.

Länge 20 cm, Klemmbackenweite 9,5 cm.



OSBORNE Nr. 93 KNEIFZANGE

Eine extrem bündig abschließende, robuste Kneifzange. Hergestellt aus geschmiedetem Stahl. Polierte Zangenenden.

**OSBORNE Nr. 708 LEDERSCHERE**

Endlich eine Schere, die weiches Leder wie Butter schneidet. Sie werden staunen, wenn Sie diese Schere zum ersten Mal ausprobieren. Messerscharfe Klinge, verchromt mit stumpfer Spitze und lackiertem Griff, jedes Blatt einzeln geschmiedet.

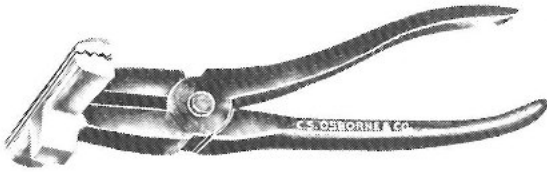
**OSBORNE Nr. 250 LEDERZANGE**

Paßgenaue, abgerundete Zähne verhindern das Verrutschen von Leder oder Segeltuch. Zange mit Hammerbacken, der Hammer wirkt wie ein Hebel, wenn ein starker Zug erforderlich ist, oder kann als Hammer benutzt werden.

Länge 222 mm, Backen 88 mm breit.

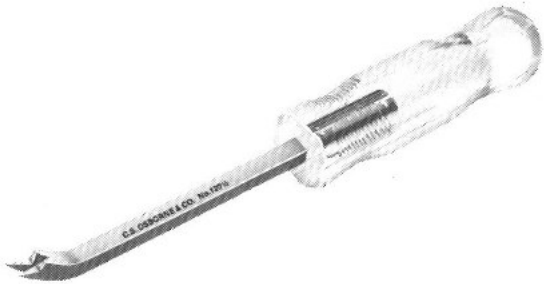
**OSBORNE Nr. 120.5 HEFTKLAMMERNENTFERNER**

Klammern werden in der Fertigung von Sätteln heute immer häufiger eingesetzt. Zur Reparatur dieser Sättel benötigt man einen Heftklammernentferner wie diesen. Der korrekte Winkel ermöglicht das Entfernen von Klammern aller Fabrikate. Das Werkzeug aus hochwertigem Stahl ist einem aufwendigen Härteverfahren unterzogen worden, so daß die Spitzen äußerst widerstandsfähig sind.

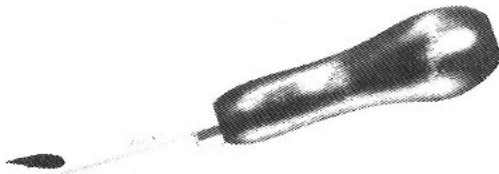
**OSBORNE Nr. 200 NAGELHEBER**

Die speziell gehärteten Spitzen liegen eng beieinander, damit man Ziernägel und Stifte leicht und ohne Beschädigung von Leder, Holz oder Stoff herausziehen kann.

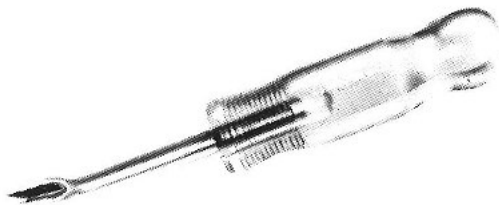
**OSBORNE Nr. 202 NAGELHEBER**

Nagelheber und Heftklammernentferner aus hochwertig geschmiedetem Stahl mit Plastikheft; spezialgehärtete-Spitzen.

Klingenlänge 70 mm.
Gesamtlänge 165 mm.

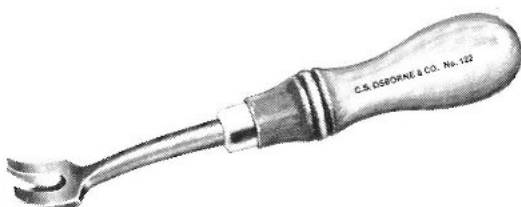
**OSBORNE Nr. 122 NAGELHEBER**

Besonders geeignet für Klammern und kleine Nägel.

OSBORNE Nr. ALLZWECKAHLE

Hergestellt in den vier abgebildeten Größen aus hochwertigem Stahl.
Die Abbildungen entsprechen der realen Größe einer einzelnen Ahle.

4-1

4-2

4-3

4-4

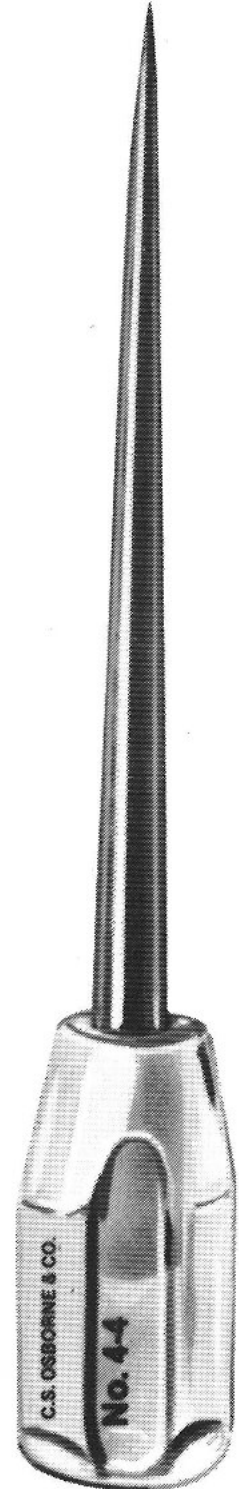
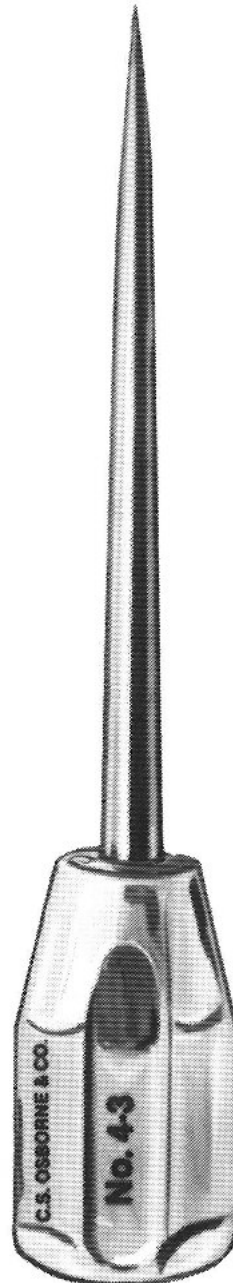
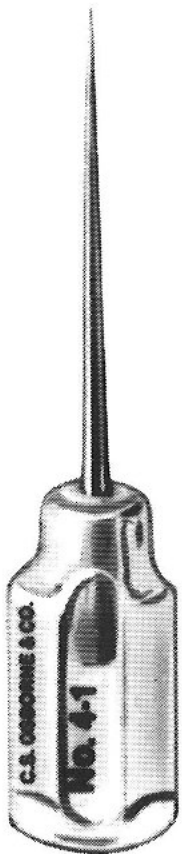

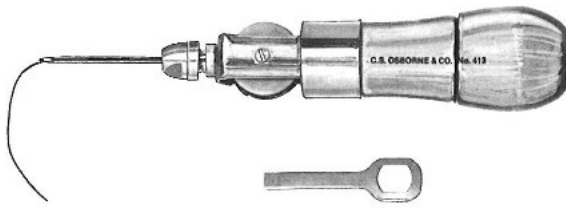

OSBORNE Nr. 413 AUTOMATISCHE AHLE

Zum Nähen von Leder, Segeltuch und ähnlichen Materialien. Die Ahle hat eine Spule mit gewachstem, schwarzen Nylonfaden im Schaft. Der hohle Griff enthält zusätzlich eine Nadel und einen Schraubenschlüssel. Eine Anleitung bei jeder Ahle erklärt, wie die Ahle effektiv bei Reparaturen eingesetzt werden kann. Ausgestattet mit einer geraden und einer gebogenen Diamantspizennadel.

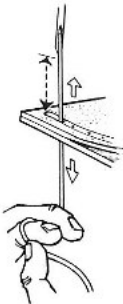
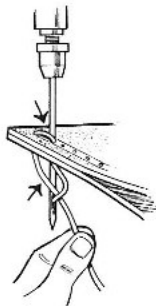
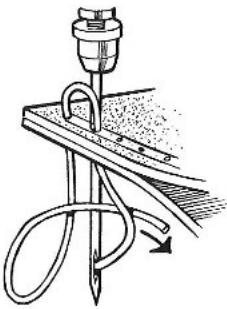
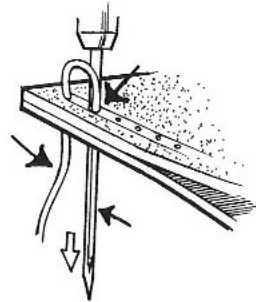
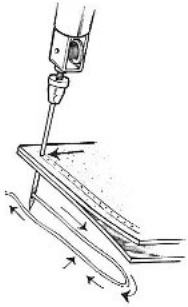

- Nr. 413 N5 gerade Nadel (ca. 12,7 cm)
- Nr. 413 N6 gebogene Nadel (ca. 15,2 cm)
- Nr. 413 N8 grobe gerade Nadel (ca. 20,3 cm)
- Nr. 413 R-B schwarze Garnspule (klein)
- Nr. 413 R-BR braune Garnspule (klein)
- Nr. 413 R-W weiße Garnspule (klein)
- Nr. 413 ST-B schwarze Garnrolle (mittel)
- Nr. 413 ST-BR braune Garnrolle (mittel)
- Nr. 413 ST-W weiße Garnrolle (mittel)
- Nr. 413 LT-B schwarze Garnrolle (groß)
- Nr. 413 LT-BR braune Garnrolle (groß)
- Nr. 413 LT-W weiße Garnrolle (groß)

Wenn Sie den Holzgriff aufschrauben, finden Sie zwei Nadeln und ein Schraubwerkzeug, mit dem Sie eine Nadel einsetzen.

Nähvorgang

Faden ungefähr doppelt so lang wie die Naht werden soll aus dem Nadelöhr herausziehen. Daraufhin den ersten Stich durch die zu vernähenden Teile machen und das lange Fadenende auf die andere Seite durchziehen.

Nadel wieder herausziehen, unter gleichwertigem Druck mit dem Daumen auf die Fadenspule. Nun je nach gewählter Stichlänge die Nadel wieder wie vorher durchstechen. Daraufhin die Nadel etwas zurückziehen, wodurch eine Schlaufe entsteht. Durch diese das lange Fadenende ziehen.

Nach nochmaligem Zurückziehen der Nadel sind beide Fäden fest anzuziehen, und zwar der eine Faden durch Druck auf die Spule, der andere mit der anderen Hand. Dann folgt der nächste Stich wie vor.

Bei einiger Übung geht der Nähvorgang sehr schnell.

Die Naht ist von beiden Seiten gleichmäßig sauber und ähnelt der Naht der Nähmaschine.

Die Stichlängen können beliebig gewählt werden, sie richten sich nach dem Material und der Beanspruchung. Ersatznadeln erhalten Sie bei Ihrem Lieferanten.

**OSBORNE Nr. 8 LOCHAHLE MIT HEFT**

Geschmiedete Lochahle mit Hartholzgriff, 25,4 cm lang. Vernieteter Griffzapfen zur Verstärkung, scharfe Schneidekanten zum Schneiden des eigenen Schlitzes, für schwere Schnüre.

**OSBORNE Nr. 8-B LOCHAHLE MIT HEFT**

Geschmiedete Lochahle mit stumpfen, polierten Kanten für vorgestanzte Leder. Hartholzgriff.

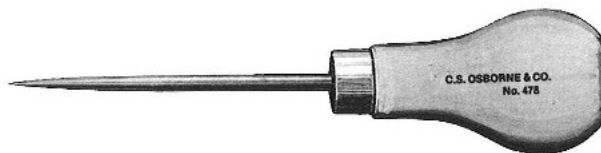
**OSBORNE Nr. 478 STECHAHLE**

Runde, lange Spitze, ca. 5 cm langer Ahlenschaft aus Stahl – zum Vorstechen von Leder, Stoffen und sonstigen Materialien.

**OSBORNE Nr. T-11 TENNISAHLE**

Stumpfe Spitze verhindert das Einritzen und Beschädigen des Leders beim Ausfluchten und sonstigen Arbeiten.

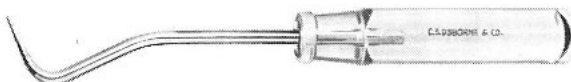
**OSBORNE Nr. 18 ALLZWECKAHLE**

Mit gehärteter Spitze. Eine sehr praktische Ahle, die effektiv an schlecht zugänglichen Stellen für viele verschiedene Arbeiten eingesetzt werden kann.



OSBORNE Nr. 143-2 AHLENHEFT
Mit Lederschlagring, vernietet.



OSBORNE Nr. 145 NÄHAHLENHEFT
Lackierter, knaufartiger Griff.



OSBORNE 142 AHLENHEFT
Neues, wunderbar ausgewogenes Ahlenheft aus amerikanischem Ahornholz.

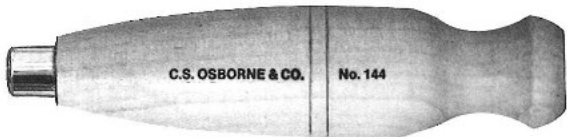

OSBORNE Nr. 144 AHLENHEFT
Klarlackiert, Messingzwinge.



OSBORNE-AHLEN

Schwertahle

| | | | | | | | | | |
|------------|----|----|----|----|----|----|----|----|----|
| Nr. | 43 | 44 | 45 | 46 | 47 | 48 | 49 | 50 | 52 |
| Länge (mm) | 44 | 50 | 57 | 63 | 66 | 70 | 73 | 76 | 82 |



Plattahlen

| | | | |
|------------|------|------|------|
| Nr. | 31-S | 31-M | 31-L |
| Länge (mm) | 63 | 76 | 89 |



Sattlerahle

| | | | | | |
|------------|----|----|----|----|----|
| Nr. | 54 | 56 | 57 | 58 | 59 |
| Länge (mm) | 50 | 57 | 63 | 70 | 76 |



Steppahle

| | | |
|------------|----|----|
| Nr. | 32 | 32 |
| Länge (mm) | 63 | 76 |



OSBORNE LEDERNADEL

Gebogen, mit geschliffener Dreikantspitze.

OSBORNE Nr. 503

Dünn.

| | | | | | | | |
|--------------|-----|-------|-----|-------|-----|-----|-----|
| Länge (Zoll) | 2 | 2 1/2 | 3 | 3 1/2 | 4 | 5 | 6 |
| ∅ (mm) | 1,0 | 1,2 | 1,6 | 1,6 | 1,8 | 1,8 | 2,0 |

OSBORNE Nr. 553

Stark.

| | | | | | |
|--------------|-----|-----|-----|-----|-----|
| Länge (Zoll) | 3 | 4 | 5 | 6 | 7 |
| ∅ (mm) | 1,0 | 2,0 | 2,4 | 2,4 | 2,6 |



OSBORNE LEDERNADEL

Gebogen, mit Dreikantspitze.

OSBORNE Nr. 502 X

Extra dünn.

| | | | | | |
|--------------|-----|-------|-----|-------|-----|
| Länge (Zoll) | 2 | 2 1/2 | 3 | 3 1/2 | 4 |
| ∅ (mm) | 0,8 | 0,9 | 1,0 | 1,2 | 1,2 |

OSBORNE Nr. 502 1/2

Dünn.

| | | | | | | | | | |
|--------|-----|-------|-----|-------|-----|-----|-----|-----|-----|
| Länge | 2 | 2 1/2 | 3 | 3 1/2 | 4 | 5 | 6 | 7 | 8 |
| ∅ (mm) | 1,0 | 1,2 | 1,2 | 1,4 | 1,4 | 1,6 | 1,8 | 1,8 | 1,8 |

OSBORNE Nr. 502

Stark.

| | | | | | | | | | | |
|--------------|-----|-------|-----|-------|-----|-----|-----|-----|-----|-----|
| Länge (Zoll) | 2 | 2 1/2 | 3 | 3 1/2 | 4 | 5 | 6 | 7 | 8 | 10 |
| ∅ (mm) | 1,4 | 1,4 | 1,6 | 1,6 | 1,8 | 2,0 | 2,0 | 2,0 | 2,4 | 2,4 |



OSBORNE LEDERNADEL

Einspitzig, mit geschliffener Dreikantspitze.

OSBORNE Nr. 506

Dünn.

| | | | | | | | |
|--------------|-----|-----|-----|-----|-----|-----|-----|
| Länge (Zoll) | 6 | 8 | 10 | 12 | 14 | 16 | 18 |
| ∅ (mm) | 2,0 | 2,0 | 2,4 | 2,4 | 2,4 | 2,6 | 2,6 |

OSBORNE Nr. 556

Stark.

| | | | | | | | |
|--------------|-----|-----|-----|-----|-----|-----|-----|
| Länge (Zoll) | 6 | 8 | 10 | 12 | 14 | 16 | 18 |
| ∅ (mm) | 2,4 | 2,4 | 2,6 | 2,6 | 2,6 | 3,0 | 3,0 |

Osborne Lederwerkzeuge * Bruttopreisliste 01.05.2016

| Art -Nr. | Bezeichnung | € |
|----------|---|----------|
| 4-1 | Ahle mit Heft 65mm | 4,60 |
| 4-2 | Ahle mit Heft 90 mm | 6,40 |
| 4-3 | Ahle mit Heft 115 mm | 8,20 |
| 4-4 | Ahle mit Heft 140 mm | 13,00 |
| 8 | Lochahle mit Heft (spitz) | 51,60 |
| 8-B | Lochahle mit Heft (stumpf) | 51,00 |
| 18 | Allzweckahle | 17,80 |
| 20-C | Reifelholz | 11,20 |
| 21 | Kantenbieger (1 - 5) | je 26,60 |
| 34 | Reißzirkel | 113,20 |
| 34/1-3 | Ersatzschneider | 25,60 |
| 34-P | Ersatzspitze | 6,60 |
| 38-C | Reißzirkel, englisch | 101,60 |
| 51 | Ziehmesser | 97,60 |
| 51-1/2B | Ersatzblatt | 12,60 |
| 55 | Sattlerhammer | 157,20 |
| 66 | Schusterhammer | 45,40 |
| 70 | Halbmondmesser | 88,00 |
| 71 | Kopfmesser | 82,20 |
| 73 | Schneidmesser für Leder | 72,40 |
| 77 | Ledermesser mit Handschutz (ersetzt Nr. 76.5) | 11,80 |
| 79.5 | Spitzes Messer | 12,00 |
| 86 | Spaltmaschine | 750,60 |
| 86-B | Ersatzmesser | 390,00 |
| 93 | Kneifzange | 28,20 |
| 106.15 | Flügelstechzirkel 15 cm | 65,20 |
| 106.20 | Flügelstechzirkel 20 cm | 67,20 |
| 106.25 | Flügelstechzirkel 25 cm | 71,80 |
| 106.30 | Flügelstechzirkel 30 cm | 72,00 |
| 117 | Füllstock , Osborne, 25 cm | 45,00 |
| 120.5 | Heftklammerentferner | 28,40 |
| 122 | Nagelheber | 27,60 |
| 125 | Allgemeiner Kantenzieher (00-5) | je 44,80 |
| 126 | Feiner Kantenzieher (0 - 6) | je 72,40 |
| 127 | Kantenzieher (1-4) | je 45,80 |
| 127.5-B | Bissonnette-Kantenzieher gebogen (0-4) | je 47,80 |
| 127.5-S | Bissonnette-Kantenzieher gerade (0-4) | je 47,80 |
| 128 | Regulierbarer Hohlmeißel (1,2,3,90 G) | je 26,80 |

| Art -Nr. | Bezeichnung | | € |
|------------|--|----|--------|
| 130-3 | Französischer Kantenzieher, Nr. 3 | | 73,20 |
| 130-4 | Französischer Kantenzieher, 6 mm | | 73,20 |
| 130-5 | Französischer Kantenzieher, 8 mm | | 74,60 |
| 130-8 | Französischer Kantenzieher, 13 mm | | 74,60 |
| 133-B | Kantenzieher gebogen (0-4) | je | 50,80 |
| 133-S | Kantenzieher gerade (0-4) | je | 50,80 |
| 142 | Ahlenheft | | 20,80 |
| 143.2 | Ahlenheft mit Lederring | | 21,20 |
| 144 | Ahlenheft | | 3,00 |
| 145 | Nähahlenheft | | 18,20 |
| 147 | Rund-Locheisen (0-6) | je | 28,80 |
| 147 | Rund-Locheisen (7-10) | je | 28,80 |
| 147 | Rund-Locheisen (11-12) | je | 30,20 |
| 147 | Rund-Locheisen (13-14) | je | 32,20 |
| 147 | Rund-Locheisen (15-16) | je | 34,00 |
| 149-6 | Henkellocheisen 6 mm | | 32,40 |
| 149-7 | Henkellocheisen 7 mm | | 32,40 |
| 149-8 | Henkellocheisen 8 mm | | 32,40 |
| 149-10 | Henkellocheisen 10 mm | | 32,40 |
| 149-11 | Henkellocheisen 11 mm | | 32,40 |
| 149-12 | Henkellocheisen 12 mm | | 39,80 |
| 149-15 | Henkellocheisen 15 mm | | 46,20 |
| 149-16 | Henkellocheisen 16 mm | | 46,20 |
| 149-18 | Henkellocheisen 18 mm | | 48,60 |
| 149-20 | Henkellocheisen 20 mm | | 53,20 |
| 149-22 | Henkellocheisen 22 mm | | 53,20 |
| 149-25 | Henkellocheisen 25 mm | | 59,60 |
| 149-30 | Henkellocheisen 30 mm | | 87,20 |
| 150-1-2 | Riemen-Endeisen rund 6,4 + 9,5 (1-2) | je | 45,20 |
| 150-3-4 | Riemen-Endeisen rund (3-4) | je | 51,00 |
| 150-5-6 | Riemen-Endeisen rund (5-6) | je | 53,60 |
| 150-7 | Riemen-Endeisen rund (7) | | 54,20 |
| 150-8-12 | Riemen-Endeisen rund 28,6 – 41,3 (8-12) | je | 57,40 |
| 150-13-14 | Riemen-Endeisen rund 44,5 – 51 (13-14) | je | 68,40 |
| 0150-1-6 | Riemen-Endeisen spitz 6,4 - 22 (1-6) | je | 49,40 |
| 0150-7 | Riemen-Endeisen spitz 25,4 (7) | je | 52,60 |
| 0150-8-12 | Riemen-Endeisen spitz 28,6 – 41,3 (8-12) | je | 64,40 |
| 0150-13-14 | Riemen-Endeisen spitz 44 - 51 (13-14) | je | 76,60 |
| 151-1-6 | Kappenlocheisen 6,4 – 22,2 (1-6) | je | 47,60 |
| 151-7 | Kappenlocheisen 25,4 (7) | | 62,40 |
| 151-8-9 | Kappenlocheisen 28,6 (8-9) | je | 64,60 |
| 151-10 | Kappenlocheisen 34,9 (10) | | 64,60 |
| 151-11-12 | Kappenlocheisen 38,1 – 50,8 (11-12) | je | 71,00 |
| 151-13-15 | Kappenlocheisen 38,1 – 50,8 (13-15) | je | 76,00 |
| 153 | Federzange | | 94,60 |
| 153 T | Ersatzpfeifen | je | 11,40 |
| 155 | Revolver-Lochzange | | 106,80 |

| Art -Nr. | Bezeichnung | | € |
|-----------|---|----|-------------|
| 155 A | Ersatzamboss | | 6,40 |
| 155 T | Ersatzpfeifen | | 9,00 |
| 155 T 0-7 | Ersatzpfeifen, komplett Nr. 0, 1, 2, 3, 5 + 7 | | 53,60 |
| K-157 | Kleines Locheisenset | | 46,80 |
| 158 | Ovales Locheisen (1-16) | je | 50,20 |
| 196-2 | Rohhauthammer | | 42,40 |
| 196-3 | Rohhauthammer | | 49,80 |
| 196-4 | Rohhauthammer | | 61,00 |
| 200 | Nagelheber | | 33,40 |
| 202 | Nagelheber | | 27,00 |
| 216-00 | Öseneinsetzwerkzeug 00 | | 63,60 |
| 227 | Sattlerhammer | | 48,00 |
| 230.13SET | Druckknopf-Set , nur Werkzeug | | 28,60 |
| 230.13-S | .100 Stück Druckknöpfe , 13 mm | | 42,60 |
| 230.13-S | .025 Stück Druckknöpfe , 13 mm | | auf Anfrage |
| 230.SET | Druckknopf-Set , nur Werkzeug | | 28,60 |
| 230-S | .100 Stück Druckknöpfe , 15 mm | | 42,60 |
| 230-S | .025 Stück Druckknöpfe , 15 mm | | auf Anfrage |
| 233 | Kombinierte Zwick- und Hammerzange | | 73,20 |
| 245-00-0 | Gurtlocheisen (00-0) | je | 8,20 |
| 245-1-6 | Gurtlocheisen (1-6) | je | 8,60 |
| 245-7-9 | Gurtlocheisen (7-9) | je | 9,40 |
| 245-10-12 | Gurtlocheisen (10-12) | je | 10,80 |
| 245-13-14 | Gurtlocheisen (13-14) | je | 12,40 |
| 245-15-16 | Gurtlocheisen (15-16) | je | 13,80 |
| K-245 | Gurtlocheisen-Set | | 65,40 |
| 250 | Lederzange | | 52,60 |
| 259 | Dehnungsklingen für Heft 460 | | 8,80 |
| 266 | Näh-Hand, (L für Linkshänder) | | 20,00 |
| 395F-1 | Ersatzköpfe für Nr. 395-1, Rohhaut | | 25,20 |
| 395F-2 | Ersatzköpfe für Nr. 395-2, Rohhaut | | 28,00 |
| 395F-3 | Ersatzköpfe für Nr. 395-3, Rohhaut | | 37,40 |
| 395-1 | Rohhaut-Hammer 1 | | 97,00 |
| 395-2 | Rohhaut-Hammer 2 | | 104,80 |
| 395-3 | Rohhaut-Hammer 3 | | 134,20 |
| 413 | Automatische Ahle | | 27,20 |
| 413-N | Ersatznadel (N5/N6/N8) | je | 5,20 |
| 413-R | Garnrolle (klein) | | 7,00 |
| 413-ST | Garnrolle (mittel) | | 35,60 |
| 425 | Falkenschnabelmesser | | 15,20 |
| 444 | Drehbarer Stossbeitel (feste Klinge) | | 26,60 |
| 446 | Drehbarer Stossbeitel mit 3 Klingen | | 84,00 |
| 446-B1-3 | Ersatzklingen (1,2,3) | je | 13,00 |
| 447 | Abstoßmesser | | 17,20 |
| 448-1 | Design-Kantenheber | | 10,00 |
| 452 | Steppbeitel | | 28,20 |
| 454 | Modellierer | | 12,40 |
| 457 | Punktierer | | 10,00 |

| Art -Nr. | Bezeichnung | € |
|----------|---------------------------------------|----------|
| 458 | Modellierer | 15,20 |
| 459 | Prägeradschlitten | 40,20 |
| 459/6-19 | Musterräder für Nr. 459 | je 12,60 |
| 460 | Klingenheft | 39,60 |
| 464 | Spitzknochen (Falzbein) | 16,60 |
| 465 | Spitzknochen synthetisch (Falzbein) | 10,80 |
| 467 | Kantenschräger | 6,80 |
| 469 | Lederschärfmesser | 48,40 |
| 471 | Modellierer | 18,00 |
| 472 | Modellierer | 13,60 |
| 473 | Modellierer | 15,40 |
| 474 | Modellierer | 6,80 |
| 475 | Modellierer | 19,00 |
| 476 | Modellierer | 12,60 |
| 478 | Stechahle | 4,20 |
| 479 | Schräges Spaltnmesser | 14,80 |
| 481 | Riemenbeitel einzinkig | 29,00 |
| 483 | Riemenbeitel dreizinkig | 29,00 |
| 484 | Riemenbeitel vierzinkig | 29,00 |
| 485 | Markierer Nr. 5, 6 und 7 | je 41,40 |
| 491 | Riemenbeitel einzinkig | 17,40 |
| 492 | Riemenbeitel zweizinkig | 17,40 |
| 493 | Riemenbeitel dreizinkig | 17,40 |
| 494 | Riemenbeitel vierzinkig | 17,40 |
| 494 D | Diagonaler Riemenbeitel | 23,00 |
| 510 | Fingerhut | 5,40 |
| 511 | Fingerhut | 5,40 |
| 603 | Schneidunterlage | 45,60 |
| 700 | Steppbeitel | 27,20 |
| 701 | Modellierer | 14,00 |
| 702 | Modellierer | 14,00 |
| 704 | Modellierer | 6,80 |
| 708 | Lederschere | 51,20 |
| 925 | Lederhobel | 11,80 |
| 925-100 | 100 Stück Ersatzklingen | 39,00 |
| 925-D | Ersatzklingen im Spender zu 20 Stück | 13,80 |
| DB1 | Entenschnabelzange | 50,20 |
| DB1-S | Entenschnabelzange, glatt | 55,00 |
| T-11 | Tennisahle | 6,80 |

Alle Preise verstehen sich zuzüglich der gesetzlichen Mehrwertsteuer.
Es gelten unsere Liefer- und Zahlungsbedingungen.

Metallwarensortiment

Karabinerhaken
Ringe
Schnallen
Schieber
Schlaufen
Kettenzubehör und Schäkkel
Ketten und Schlüsselketten
Drahtseilzubehör
Ringmuttern, Ringschrauben, Deckenhaken
Und sonstige Befestigungsmittel
Klappsplinte, Rohrklopstecker und Federstecker

Erklärung:

| | | |
|------|----------------|--------------------|
| B | brass | Messing |
| I | stainles steel | Edelstahl |
| K | thimble | Kausche |
| M/TG | mal. cast iron | Temperguß |
| P | plastic | Plastik |
| S | screw | Schraube |
| Z | zinc die cast | Zinkdruckguß |
| NP | nickel plated | vernickelt |
| BP | brass plated | vermessingt |
| CP | chrome plated | verchromt |
| ZP | zinc plated | verzinkt |
| EG | metric thread | metrisches Gewinde |
| HG | wooden thread | Holzgewinde |

Angegeben werden in der Regel die Innenmaße in engl. Zoll:



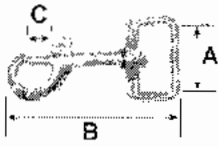

1 Zoll - 2,54 cm
7/8 Zoll - 2,22 cm
3/4 Zoll - 1,91 cm
5/8 Zoll - 1,59 cm
1/2 Zoll - 1,27 cm
3/8 Zoll - 0,97 cm

Bolzenkarabinerhaken aus Zinkdruckguß und Tempereguß
 trigger-hooks made from zinc die cast and malleable cast iron

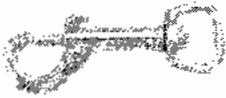

D = Gewicht (kg) bei 100 Stück
 weight (kgs) per 100 pieces

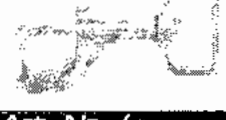
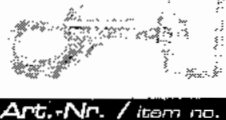
Alle Maße in mm
 all measurements in mm

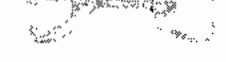
| Art.-Nr. / item no. | Art.-Nr. / item-no. | A | B | C | D | |
|---|--|------------------------|---------------|---------------|---------------|----------------|
| 0148-Z | | | | | | |
|  | Bolzenkarabinerhaken aus Zinkdruckguß mit drehbarem Wirbel, vernickelt trigger-hook made from zinc die cast with movable swivel, nickel plated | 0148-Z-3/4" | 20 | 52 | 7 | 1,0 |
| 0169-Z | | | | | | |
|  | Bolzenkarabinerhaken aus Zinkdruckguß mit drehbarem Wirbel, vernickelt trigger-hook made from zinc die cast with movable swivel, nickel plated | * 0169-Z-5/8" | 16 | 74 | 10 | 2,3 |
| 017-AZ | | | | | | |
|  | Bolzenkarabinerhaken aus Zinkdruckguß mit drehbarem Wirbel, vernickelt trigger-hook made from zinc die cast with movable swivel, nickel plated | * 017-AZ-1" | 25 | 82 | 8 | 4,5 |
| 017-HM | | | | | | |
|  | Bolzenkarabinerhaken aus Tempereguß mit drehbarem Wirbel, vernickelt trigger-hook made from malleable cast iron with movable swivel, nickel plated | 017-HM-1 1/4" | 31 | 93 | 10 | 8,1 |
| 017-HZ | | | | | | |
|  | Bolzenkarabinerhaken aus Zinkdruckguß mit drehbarem Wirbel, vernickelt trigger-hook made from zinc die cast with movable swivel, nickel plated | 017-HZ -1" | 25 | 80 | 13 | 5,5 |
| 017-Z | | | | | | |
|  | Bolzenkarabinerhaken aus Zinkdruckguß mit drehbarem Wirbel, vernickelt trigger-hook made from zinc die cast with movable swivel, nickel plated | 017-Z-1" | 25 | 82 | 10 | 4,2 |
| | | 017-Z 3/4" | 20 | 79 | 12 | 4,1 |
| 0170-Z | | | | | | |
|  | Bolzenkarabinerhaken aus Zinkdruckguß mit drehbarem Wirbel, vernickelt trigger-hook made from zinc die cast with movable swivel, nickel plated | 0170-Z-3/4" | 20 | 77 | 10 | 2,8 |
| | | 0170-Z 5/8" | 16 | 75 | 10 | 2,6 |
| 0171-Z | | | | | | |
|  | Bolzenkarabinerhaken aus Zinkdruckguß mit drehbarem Wirbel, vernickelt trigger-hook made from zinc die cast with movable swivel, nickel plated | 0171-Z-3/4" | 20 | 65 | 8 | 2,0 |
| | | 0171-Z 5/8" | 16 | 65 | 8 | 1,6 |

Bolzenkarabinerhaken aus Zinkdruckguß und Temperguß
 trigger-hooks made from zinc die cast and malleable cast iron

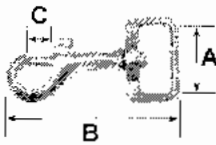

D = Gewicht (kg) bei 100 Stück
 weight (kgs) per 100 pieces

Alle Maße in mm
 all measurements in mm

| Art.-Nr. / item no. | Art.-Nr. / item-no. | A | B | C | D |
|---------------------|---------------------|---|---|---|---|
| 125-Z | | | | | |

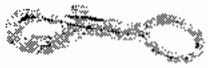

Bolzenkarabinerhaken aus Zinkdruckguß mit festem Auge, vernickelt

trigger-hook made from zinc die cast with fixed eye, nickel plated

125-Z-3/4"

20 80 10 3,8

125-Z-5/8"

16 82 10 3,6

| Art.-Nr. / item no. | Art.-Nr. / item-no. | A | B | C | D |
|-----------------------|---------------------|---|---|---|---|
| 161-Z / 162-Z / 163-Z | | | | | |

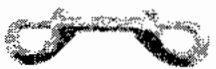

Bolzenkarabinerhaken aus Zinkdruckguß mit beidseitigem Schnäpper, vernickelt

double end bolt with side latches made from zinc die cast, nickel plated

163-Z

117 11 7,0

162-Z

100 10 4,8

161-Z

88 10 3,6

| Art.-Nr. / item no. | Art.-Nr. / item-no. | A | B | C | D |
|---------------------|---------------------|---|---|---|---|
| 181-Z / 182-Z | | | | | |



Bolzenkarabinerhaken aus Zinkdruckguß mit drehbarem Wirbel, vernickelt

trigger-hook made from zinc die cast with movable swivel, nickel plated

182-Z-1"

25 60 8 2,0

181-Z-1"

25 52 7 1,0

| Art.-Nr. / item no. | Art.-Nr. / item-no. | A | B | C | D |
|---------------------|---------------------|---|---|---|---|
| 205-Z | | | | | |



Bolzenkarabinerhaken aus Zinkdruckguß mit drehbarem Wirbel, vernickelt

trigger-hook made from zinc die cast with movable swivel, nickel plated

* 205-Z-1/4"

6 46 4 0,8

| Art.-Nr. / item no. | Art.-Nr. / item-no. | A | B | C | D |
|---------------------|---------------------|---|---|---|---|
| 225-AZ | | | | | |



Bolzenkarabinerhaken aus Zinkdruckguß mit drehbarem Wirbel, vernickelt

trigger-hook made from zinc die cast with movable swivel, nickel plated

225-AZ-3/4"

20 81 8 4,8

| Art.-Nr. / item no. | Art.-Nr. / item-no. | A | B | C | D |
|---------------------|---------------------|---|---|---|---|
| 225-HZ | | | | | |



Bolzenkarabinerhaken aus Zinkdruckguß mit drehbarem Wirbel, vernickelt

trigger-hook made from zinc die cast with movable swivel, nickel plated

225-HZ-1 1/4"

31 119 12 6,8

* 225-HZ-1"

25 117 12 7,8

225-HZ-5/8"

16 85 12 5,7

| Art.-Nr. / item no. | Art.-Nr. / item-no. | A | B | C | D |
|---------------------|---------------------|---|---|---|---|
| 225-Z | | | | | |



Bolzenkarabinerhaken aus Zinkdruckguß mit drehbarem Wirbel, vernickelt

trigger-hook made from zinc die cast with movable swivel, nickel plated

225-Z-1"

25 96 8 4,6

225-Z-7/8"

22 95 8 4,7

* # 225-Z-3/4"

20 90 11 4,3

* # 225-Z-5/8"

16 88 9 4,1

225-Z-1/2"

12 85 9 4,1

| Art.-Nr. / item no. | Art.-Nr. / item-no. | A | B | C | D |
|---------------------|---------------------|---|---|---|---|
| 230-M / 231-M | | | | | |

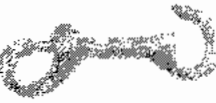

Bolzenkarabinerhaken aus Temperguß mit Zuschlageuge, verzinkt

trigger-hook made from malleable cast iron, zinc plated

231-M

10 90 11 6,0

230-M





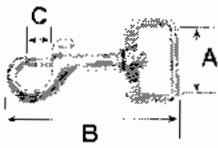

6 88 7 4,1

Bolzenkarabinerhaken aus Zinkdruckguß und Temperguß
 trigger-hooks made from zinc die cast and malleable cast iron



D = Gewicht (kg) bei 100 Stück
 weight (kgs) per 100 pieces

Alle Maße in mm
 all measurements in mm

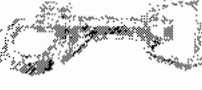
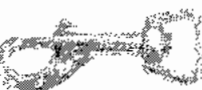



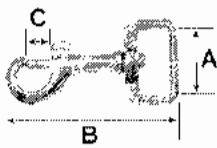

| Art.-Nr. / item no. | | Art.-Nr. / item-no. | A | B | C | D |
|---|---|--|---------------|---------------|---------------|----------------|
| 47-Z-SQ | | 47-Z-3/4" SQ | 20 | 68 | 7 | 3,1 |
|  | Bolzenkarabinerhaken aus Zinkdruckguß mit drehbarem Wirbel, vernickelt trigger-hook made from zinc die cast with movable swivel, nickel plated | | | | | |
| 4901-Z | | 4901-Z-1" | 25 | 62 | 6 | 1,9 |
|  | Bolzenkarabinerhaken aus Zinkdruckguß mit drehbarem Wirbel, vernickelt trigger-hook made from zinc die cast with movable swivel, nickel plated | 4901-Z-3/4" | 20 | 60 | 6 | 1,8 |
| 5025-Z | | *# 5025-Z-3/4" | 20 | 82 | 11 | 2,8 |
|  | Bolzenkarabinerhaken aus Zinkdruckguß mit drehbarem Wirbel, vernickelt trigger-hook made from zinc die cast with movable swivel, nickel plated | *# 5025-Z-5/8" | 16 | 84 | 8 | 3,2 |
| | | *# 5025-Z-1/2" | 12 | 78 | 8 | 2,7 |
| | | 5025-Z-3/8" | 10 | 75 | 11 | 2,7 |
| 5045-Z | | 5045-Z-1/2" | 12 | 62 | 6 | 1,6 |
|  | Bolzenkarabinerhaken aus Zinkdruckguß mit drehbarem Wirbel, vernickelt trigger-hook made from zinc die cast with movable swivel, nickel plated | 5045-Z-3/8" | 10 | 62 | 6 | 1,6 |
| 505-RZ | | 505-RZ-1" | 25 | 89 | 11 | 3,2 |
|  | Bolzenkarabinerhaken aus Zinkdruckguß mit drehbarem Wirbel u. Schlüsselr., vernickelt trigger-hook made from zinc die cast with mov. swivel and key-ring, nickel plated | | | | | |
| | | Gesamtlänge ohne Schlüsselring = 73 mm outside length without key-ring = 73 mm | | | | |
| 5055-Z | | * 5055-Z-1/2" | 12 | 65 | 8 | 1,8 |
|  | Bolzenkarabinerhaken aus Zinkdruckguß mit drehbarem Wirbel, vernickelt trigger-hook made from zinc die cast with movable swivel, nickel plated | 5055-Z-3/8" | 10 | 62 | 7 | 1,7 |
| 53-AZ | | 53-AZ-3/4" CP | 20 | 81 | 9 | 4,3 |
|  | Bolzenkarabinerhaken aus Zinkdruckguß mit drehbarem Wirbel, verchromt trigger-hook made from zinc die cast with movable swivel, chrome plated | | | | | |
| 53-Z | | 53-Z-3/4" | 20 | 81 | 9 | 3,8 |
|  | Bolzenkarabinerhaken aus Zinkdruckguß mit drehbarem Wirbel, vernickelt trigger-hook made from zinc die cast with movable swivel, nickel plated | | | | | |

Bolzenkarabinerhaken aus Zinkdruckguß und Temperguß
 trigger-hooks made from zinc die cast and malleable cast iron

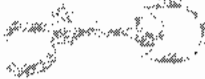

D = Gewicht (kg) bei 100 Stück
 weight (kgs) per 100 pieces

Alle Maße in mm
 all measurements in mm

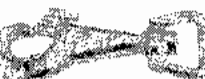
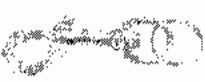
| Art.-Nr. / item no. | Art.-Nr. / item-no. | A | B | C | D | |
|---|--|---|---------------|----------------|--------------|----------------|
| 5579-Z | | | | | | |
|  | Bolzenkarabinerhaken aus Zinkdruckguß mit drehbarem Wirbel, vernickelt | 5579-Z-1/2" | 12 | 55 | 7 | 1,1 |
| | trigger-hook made from zinc die cast with movable swivel, nickel plated | # 5579-Z 3/8" | 10 | 54 | 7 | 1,1 |
| 57-Z | | | | | | |
|  | Bolzenkarabinerhaken aus Zinkdruckguß mit drehbarem Wirbel, vernickelt | # 57-Z-3/4" | 20 | 6,7 | 9 | 4,3 |
| | trigger-hook made from zinc die cast with movable swivel, nickel plated | # 57-Z 5/8" | 16 | 6,2 | 9 | 4,3 |
| 58-Z | | | | | | |
|  | Bolzenkarabinerhaken aus Zinkdruckguß mit drehbarem Wirbel, vernickelt | 58-Z-1" | 25 | 78 | 8 | 4,6 |
| | trigger-hook made from zinc die cast with movable swivel, nickel plated | # 58-Z 3/4" | 20 | 78 | 7 | 4,5 |
| 59-SZ | | | | | | |
|  | Bolzenkarabinerhaken aus Zinkdruckguß mit drehbarem Wirbel und Sicherung, vernickelt | 59-SZ-3/4" | 20 | 68 | 11 | 4,9 |
| | trigger-hook made from zinc die cast with mov. swivel and safety f., nickel plated | | | | | |
| 59-Z | | | | | | |
|  | Bolzenkarabinerhaken aus Zinkdruckguß mit drehbarem Wirbel, vernickelt | # 59-Z-3/4" | 20 | 63 | 8 | 5,6 |
| | trigger-hook made from zinc die cast with movable swivel, nickel plated | # 59-Z 5/8" | 16 | 60 | 8 | 5,3 |
| 60-Z | | | | | | |
|  | Bolzenkarabinerhaken aus Zinkdruckguß mit drehbarem Wirbel, vernickelt | 60-Z-1" | 25 | 65 | 8 | 5,7 |
| | trigger-hook made from zinc die cast with movable swivel, nickel plated | # 60-Z 7/8" | 22 | 63 | 8 | 5,4 |
| 61-Z | | | | | | |
|  | Bolzenkarabinerhaken aus Zinkdruckguß mit drehbarem Wirbel, vernickelt | 61-Z-3/4" | 20 | 64 | 8 | 5,3 |
| | trigger-hook made from zinc die cast with movable swivel, nickel plated | | | | | |
| 7112-K | | | | | | |
|  | Bolzenkarabinerhaken aus Zinkdruckguß mit drehbarem Wirbel u. Schlüsselring, vernickelt | 7112-K | 20 | 95 | 8 | 2,8 |
| | trigger-hook made from zinc die cast with mov. swivel and key-ring, nickel plated | Gesamtlänge ohne Schlüsselring = 76 mm outside length without key ring = 76 mm | | | | |
| | | auch in farbig lackiert lieferbar = not/pink/schwarz/blau/weiß/waldgrün also available in color coated = red/pink/black/blue/white/not/pink/grün blue/green | | | | |

Bolzenkarabinerhaken aus Zinkdruckguß und Temperguß
 trigger-hooks made from zinc die cast and malleable cast iron



D = Gewicht (kg) bei 100 Stück
 weight (kgs) per 100 pieces

Alle Maße in mm
 all measurements in mm

| Art.-Nr. / item no. | Art.-Nr. / item-no. | A | B | C | D |
|---------------------|---------------------|---|---|---|---|
|---------------------|---------------------|---|---|---|---|

7113-K

7113-K

20

84

9

2,0

Bolzenkarabinerhaken aus Zinkdruckguß mit drehbarem Wirbel u. Schlüsselr., vernickelt

Gesamtlänge ohne Schlüsselring = 65 mm
 outside length without key ring = 65 mm



trigger hook made from zinc die cast with mov. swivel and key-ring, nickel plated

auch in farbig lackiert lieferbar = rot/pink/schwarz/ölkis/bleiweiß/bunt/bleu/grün
 also available in color coated = red/pink/black/olive/leadwhite/bunt/bleu/green

| Art.-Nr. / item no. | Art.-Nr. / item-no. | A | B | C | D |
|---------------------|---------------------|---|---|---|---|
|---------------------|---------------------|---|---|---|---|

801-Z

801-Z-3/8"

10

34

6

0,2

Bolzenkarabinerhaken aus Zinkdruckguß mit drehbarem Wirbel, vernickelt

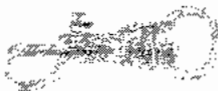

trigger-hook made from zinc die cast with movable swivel, nickel plated

| Art.-Nr. / item no. | Art.-Nr. / item-no. | A | B | C | D |
|---------------------|---------------------|---|---|---|---|
|---------------------|---------------------|---|---|---|---|

D650T-Z-R

D650T-Z-R-3/4"

20

87

12

4,2

Bolzenkarabinerhaken aus Zinkdruckguß mit drehbarem Wirbel, vernickelt

D650T-Z-R-5/8" 16 85 12 3,9
 D650T-Z-R-1/2" 12 78 11 3,5



trigger-hook made from zinc die cast with movable swivel, nickel plated

| Art.-Nr. / item no. | Art.-Nr. / item-no. | A | B | C | D |
|---------------------|---------------------|---|---|---|---|
|---------------------|---------------------|---|---|---|---|

D650-Z-R

D650-Z-R-3/4"

20

87

11

3,6

Bolzenkarabinerhaken aus Zinkdruckguß mit drehbarem Wirbel, vernickelt

D650-Z-R-5/8" 16 81 8 3,5
 D650-Z-R-1/2" 12 78 11 3,5



trigger-hook made from zinc die cast with movable swivel, nickel plated

| Art.-Nr. / item no. | Art.-Nr. / item-no. | A | B | C | D |
|---------------------|---------------------|---|---|---|---|
|---------------------|---------------------|---|---|---|---|

D650-Z-6-SQ

D650-Z-6-SQ-3/4"

20

80

11

4,0

Bolzenkarabinerhaken aus Zinkdruckguß mit drehbarem Wirbel, vernickelt

D650-Z-6-SQ-5/8" 16 76 8 3,0





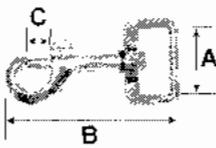

trigger-hook made from zinc die cast with movable swivel, nickel plated

Sonstige Karabinerhaken aus Zinkdruckguß und Temperguß
miscellaneous trigger-hooks made from zinc die cast and malleable cast iron

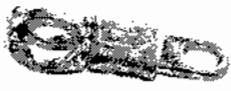

D = Gewicht (kg) bei 100 Stück
 weight (kgs) per 100 pieces

Alle Maße in mm
 all measurements in mm

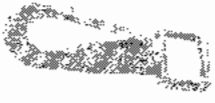
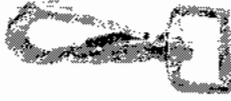
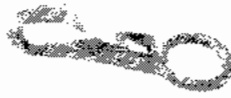



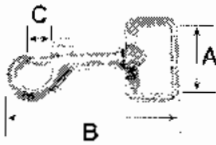



| Art.-Nr. / item no. 100-Z | Art.-Nr. / item-no. | A | B | C | D |
|--|-----------------------------------|---|-----|----|------|
|  | * 100-Z-1" 100-Z-7/8" | 25 | 58 | 10 | 3,9 |
| Karabinerhaken aus Zinkdruckguß mit feststehender Öse, vernickelt <i>trigger hook made from zinc die cast with fixed eye, nickel plated</i> | | | | | |
| Art.-Nr. / item no. 1001-Z | Art.-Nr. / item-no. | A | B | C | D |
|  | * 1001-Z-1/2" | 12 | 104 | 19 | 13,4 |
| Panikhaken aus Zinkdruckguß mit feststehender Öse, vernickelt <i>panic-snap made from zinc die cast with fixed eye, nickel plated</i> | | | | | |
| Art.-Nr. / item no. 1002-Z-SG | Art.-Nr. / item-no. | A | B | C | D |
|  | 1002-Z-1" SG NP 1002-Z-1" R ZP | 25 | 107 | 18 | 15,6 |
| Panikhaken aus Zinkdruckguß mit drehbarem Wirbel, vernickelt <i>panic-snap made from zinc die cast with movable swivel, nickel plated</i> | | | | | |
| | | 1002-Z-1" R ZP mit Rundwirbel !!! 1002-Z-1" R ZP with round swivel !!! | | | |
| Art.-Nr. / item no. 1011-Z | Art.-Nr. / item-no. | A | B | C | D |
|  | 1011-Z-5/8" | 16 | 99 | 12 | 10,5 |
| Panikhaken aus Zinkdruckguß mit feststehender Öse, vernickelt <i>panic-snap made from zinc die cast with fixed eye, nickel plated</i> | | | | | |
| Art.-Nr. / item no. 105-Z | Art.-Nr. / item-no. | A | B | C | D |
|  | 105-Z-3/4" | 20 | 70 | 10 | 4,3 |
| Karabinerhaken aus Zinkdruckguß mit feststehender Öse, vernickelt <i>snap-hook made from zinc die cast with fixed eye, nickel plated</i> | | | | | |
| Art.-Nr. / item no. 200-Z | Art.-Nr. / item-no. | A | B | C | D |
|  | 200-Z-1" 200-Z-3/4" | 25 | 77 | 12 | 3,6 |
| Karabinerhaken aus Zinkdruckguß mit Blattfeder u. feststehender Öse, vernickelt <i>snap-hook made from zinc die cast with flat spring and fixed eye, nickel plated</i> | | | | | |
| Art.-Nr. / item no. 201-Z | Art.-Nr. / item-no. | A | B | C | D |
|  | 201-Z-1" | 25 | 84 | 13 | 4,4 |
| Karabinerhaken aus Zinkdruckguß mit Blattfeder u. drehbarem Wirbel, vernickelt <i>snap-hook made from zinc die cast with flat spring and mov. swivel, nickel plated</i> | | | | | |
| Art.-Nr. / item no. 202-TG | Art.-Nr. / item-no. | A | B | C | D |
|  | 202-TG-3/4" | 20 | 87 | 13 | 3,6 |
| Karabinerhaken aus Temperguß mit Blattfeder u. feststehender Öse, vernickelt <i>snap-hook made from malleable cast iron with flat spring and fixed eye, nickel plated</i> | | | | | |

Sonstige Karabinerhaken aus Zinkdruckguß und Temperguß
 miscellaneous trigger-hooks made from zinc die cast and malleable cast iron



D = Gewicht (kg) bei 100 Stück
 weight (kgs) per 100 pieces

Alle Maße in mm
 all measurements in mm





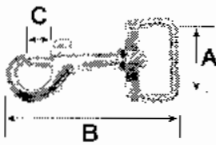

| Art.-Nr. / item no. | Art.-Nr. / item-no. | A | B | C | D |
|---|---|----------------|----------------|-------------|-------------------|
| 222-Z | | | | | |
|  | 222-Z-3/4" 222-Z-5/8" | 20 16 | 93 90 | 12 12 | 4,6 4,4 |
| | Karabinerhaken aus Zinkdruckguß mit Blattfeder u. drehbarem Wirbel, vernickelt snap-hook made from zinc die cast with flat spring and mov. swivel, nickel plated | | | | |
| 241-ZT | | | | | |
|  | 241-ZT-9/16" | 14 | 47 | 5 | 0,6 |
| | Karabinerhaken aus Zinkdruckguß mit drehbarem Wirbel, vernickelt snap-hook made from zinc die cast with movable swivel, nickel plated | | | | |
| 242-ZS | | | | | |
|  | 242-ZS-1" 242-ZS-3/4" 242-ZS-5/8" | 25 20 16 | 42 48 41 | 5 5 5 | 0,5 0,4 0,4 |
| | Karabinerhaken aus Zinkdruckguß mit drehbarem Wirbel, vernickelt snap-hook made from zinc die cast with movable swivel, nickel plated | | | | |
| 300-Z | | | | | |
|  | 300-Z-3/4" | 20 | 58 | 9 | 1,6 |
| | Karabinerhaken aus Zinkdruckguß mit Blattfeder u. feststehender Öse, vernickelt snap-hook made from zinc die cast with flat spring and fixed eye, nickel plated | | | | |
| 3142-Z-R | | | | | |
|  | 3142-Z-7/8" R | 22 | 101 | 15 | 13,5 |
| | Bullenhaken aus Zinkdruckguß mit drehbarem Wirbel, vernickelt bull-snap made from zinc die cast with movable swivel, nickel plated | | | | |
| 3142-M-SQ | | | | | |
|  | 3142-M-1" SQ | 25 | 100 | 15 | 13,5 |
| | Bullenhaken aus Temperguß mit drehbarem Wirbel, vernickelt bull-snap made from malleable cast iron with movable swivel, nickel plated | | | | |
| 333-M | | | | | |
|  | 333-M-1 1/8" | 28 | 135 | 19 | 24,0 |
| | Bullenhaken (Jumbo) aus Temperguß mit drehbarem Wirbel, vernickelt bull-snap made from malleable cast iron with movable swivel, nickel plated | | | | |
| 340-Z | | | | | |
|  | 340-Z-1" 340-Z-3/4" 340-Z-5/8" | 25 20 16 | 43 48 45 | 6 6 6 | 0,7 0,7 0,7 |
| | Karabinerhaken aus Zinkdruckguß mit Blattfeder u. feststehender Öse, vernickelt snap-hook made from zinc die cast with flat spring and fixed eye, nickel plated | | | | |

Sonstige Karabinerhaken aus Zinkdruckguß und Temperguß
miscellaneous trigger-hooks made from zinc die cast and malleable cast iron

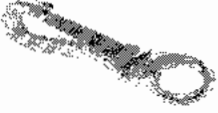

D = Gewicht (kg) bei 100 Stück
 weight (kgs) per 100 pieces

Alle Maße in mm
 all measurements in mm





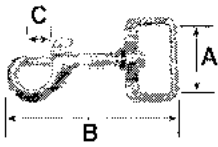

| Art.-Nr. / item no. | Art.-Nr. / item no. | A | B | C | D |
|---|--|----------------------|----------------------|----------------------|--------------------------|
| 341-Z | 341-Z-3/8" | 10 | 52 | 6 | 0,6 |
|  | Karabinerhaken aus Zinkdruckguß mit Blattfeder u. feststehender Öse, vernickelt <i>snap-hook made from zinc die cast with flat spring and fixed eye, nickel plated</i> | | | | |
| 4218-Z | 4218-Z-3/4" 4218-Z-5/8" | 20 16 | 78 72 | 18 13 | 4,5 4,4 |
|  | Karabinerhaken aus Zinkdruckguß mit drehbarem Wirbel, vernickelt <i>snap-hook made from zinc die cast with movable swivel, nickel plated</i> | | | | |
| 437-Z | 437-Z-3/4" 437-Z-3/8" | 20 10 | 72 62 | 6 6 | 1,9 1,9 |
|  | Karabinerhaken aus Zinkdruckguß mit Blattfeder u. drehbarem Wirbel, vernickelt <i>snap-hook made from zinc die cast with flat spring and mov. swivel, nickel plated</i> | | | | |
| 5013-Z | 5013-Z-3/4" 5013-Z-5/8" 5013-Z-1/2" 5013-Z-3/8" | 20 16 12 10 | 66 62 59 57 | 12 10 10 10 | 3,2 2,8 2,6 2,6 |
|  | Karabinerhaken aus Zinkdruckguß mit drehbarem Wirbel, vernickelt <i>snap-hook made from zinc die cast with movable swivel, nickel plated</i> | | | | |
| 5015-Z | 5015-Z-1" 5015-Z-3/4" 5015-Z-5/8" | 25 20 16 | 66 62 59 | 12 10 10 | 3,2 2,8 2,6 |
|  | Karabinerhaken aus Zinkdruckguß mit drehbarem Wirbel, vernickelt <i>snap-hook made from zinc die cast with movable swivel, nickel plated</i> | | | | |
| 5016-Z | 5016-Z-1" 5016-Z-3/4" | 25 20 | 104 93 | 13 15 | 7,5 6,5 |
|  | Karabinerhaken aus Zinkdruckguß mit drehbarem Wirbel, vernickelt <i>snap-hook made from zinc die cast with movable swivel, nickel plated</i> | | | | |
| 5017-Z | 5017-Z-1" | 25 | 85 | 12 | 6,8 |
|  | Karabinerhaken aus Zinkdruckguß mit drehbarem Wirbel, vernickelt <i>snap-hook made from zinc die cast with movable swivel, nickel plated</i> | | | | |

Sonstige Karabinerhaken aus Zinkdruckguß und Tempereguß
miscellaneous trigger-hooks made from zinc die cast and malleable cast iron



D = Gewicht (kg) bei 100 Stück
weight (kg) per 100 pieces

Alle Maße in mm
all measurements in mm

| Art.-Nr. / item no. | Art.-Nr. / item no. | A | B | C | D |
|--|---------------------|----|----|---|-----|
| 5037-Z  | 5037-Z-3/8" | 10 | 64 | 7 | 1,5 |
| Karabinerhaken aus Zinkdruckguß mit Blattfeder u. drehbarem Wirbel, vernickelt <i>snap-hook made from zinc die cast with flat spring and mov. swivel, nickel plated</i> | | | | | |
| 577-Z  | 577-Z-3/8" | 10 | 42 | 6 | 0,5 |
| Karabinerhaken aus Zinkdruckguß mit drehbarem Wirbel, vernickelt <i>snap-hook made from zinc die cast with movable swivel, nickel plated</i> | | | | | |
| 578-Z  | 578-Z-1/4" | 8 | 39 | 5 | 0,4 |
| Karabinerhaken aus Zinkdruckguß mit drehbarem Wirbel, vernickelt <i>snap-hook made from zinc die cast with movable swivel, nickel plated</i> | | | | | |
| 579-Z  | 579-Z-3/4" | 20 | 60 | 5 | 0,8 |
| Karabinerhaken aus Zinkdruckguß mit drehbarem Wirbel u. Schlüsselr., vernickelt <i>snap-hook made from zinc die cast with mov. swivel and key-ring, nickel plated</i> | | | | | |
| 830-Z  | 830-Z-3/4" | 20 | 67 | 8 | 5,3 |
| Karabinerhaken aus Zinkdruckguß mit drehbarem Wirbel, vernickelt <i>snap-hook made from zinc die cast with movable swivel, nickel plated</i> | | | | | |
| 8001-Z  | 8001-Z-1" | 25 | 61 | 7 | 3,1 |
| Karabinerhaken aus Zinkdruckguß mit drehbarem Wirbel, vernickelt <i>snap-hook made from zinc die cast with movable swivel, nickel plated</i> | | | | | |
| 0250-Z  | 0250-Z-1" | 25 | 49 | 6 | 1,1 |
| | 0250-Z-3/4" | 20 | 48 | 6 | 1,0 |
| | 0250-Z-5/8" | 16 | 48 | 6 | 0,8 |
| Karabinerhaken aus Zinkdruckguß mit drehbarem Wirbel, vernickelt <i>snap-hook made from zinc die cast with movable swivel, nickel plated</i> | | | | | |

Karabinerhaken aus Stahl snap-hooks made from steel

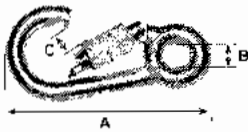

D = Gewicht (kg) bei 100 Stück
weight (kgs) per 100 pieces

Alle Maße in mm
all measurements in mm

| Art.-Nr. / item no. | Art.-Nr. / item-no. | A | B | C | D |
|---------------------|---------------------|---|---|---|---|
|---------------------|---------------------|---|---|---|---|

115-D

115-D

76 17 11 3,0

Karabinerhaken aus Stahldraht mit Blattfeder und fester Öse, verzinkt



snap-hook made from steel wire with flat spring and fixed eye, zinc plated

| Art.-Nr. / item no. | Art.-Nr. / item-no. | A | B | C | D |
|---------------------|---------------------|---|---|---|---|
|---------------------|---------------------|---|---|---|---|

150

150

90 18 13 15,5

Karabinerhaken aus Stahl mit Blechschnäpper, verzinkt



snap-hook made from steel with safety photo, zinc plated

| Art.-Nr. / item no. | Art.-Nr. / item-no. | A | B | C | D |
|---------------------|---------------------|---|---|---|---|
|---------------------|---------------------|---|---|---|---|

155

155-120

119 15 20 37,5

Zugkettanhaken aus Stahl, verzinkt



chain hook made from steel, zinc plated

155-100

112 14 18 28,5

155-90

100 13 20 18,0

155-80

88 11 15 14,5

155-70

60 11 14 10,4

155-60

68 9 15 6,8

155-50

55 8 14 4,0

| Art.-Nr. / item no. | Art.-Nr. / item-no. | A | B | C | D |
|---------------------|---------------------|---|---|---|---|
|---------------------|---------------------|---|---|---|---|

226

226-80x8

81 10 11 7,0

Karabinerhaken aus geschm. Stahl ähnl. E-DIN 5299, verzinkt



snap-hook made from steel (forged) acc. E-DIN 5299, zinc plated

226-70x7

72 10 11 4,5

226-60x6

61 9 9 3,0

| Art.-Nr. / item no. | Art.-Nr. / item-no. | A | B | C | D |
|---------------------|---------------------|---|---|---|---|
|---------------------|---------------------|---|---|---|---|

226-S

226-S-80x8

81 10 11 7,0

Karabinerhaken aus geschm. Stahl ähnl. E-DIN 5299 mit Schraubverschluß, verzinkt



snap-hook made from steel (forged) acc. E-DIN 5299 w. safety screw, zinc plated

226-S-70x7

72 11 9 4,5

226-S-60x6

62 9 9 3,0

| Art.-Nr. / item no. | Art.-Nr. / item-no. | A | B | C | D |
|---------------------|---------------------|---|---|---|---|
|---------------------|---------------------|---|---|---|---|

2311-V

2311-V

92 18 16 14,5

Karabinerhaken aus Stahl mit Federschnäpper, verzinkt



snap-hook made from steel with safety spring, zinc plated

| Art.-Nr. / item no. | Art.-Nr. / item-no. | A | B | C | D |
|---------------------|---------------------|---|---|---|---|
|---------------------|---------------------|---|---|---|---|

245

245-200x15

200 24 31 57,0

Karabinerhaken aus Stahl ähnl. C-DIN 5299, verzinkt



snap-hook made from steel acc. C-DIN 5299, zinc plated

245-180x14

162 24 34 46,5

245-160x13

161 16 26 34,0

245-140x12

142 20 20 25,0

245-120x11

121 18 18 18,0

245-100x10

100 16 15 12,5

245-90x9

90 13 14 8,5

245-80x8

81 12 11 6,0

245-70x7

71 10 9 4,0

245-60x6

61 9 8 2,5

245-50x5

51 8 7 1,5

245-40x4

40 6 7 1,0

Karabinerhaken aus Stahl snap-hooks made from steel

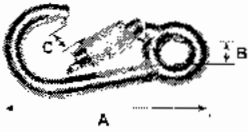

D = Gewicht (kg) bei 100 Stück
weight (kgs) per 100 pieces

Alle Maße in mm
all measurements in mm

| Art.-Nr. / item no. | Art.-Nr. / item no. | A | B | C | D |
|--|---------------------|-----|----|-----|------|
| 245-K | | | | | |
| <p>Karabinerhaken aus Stahl ähnl. C-DIN 5299 mit Kausche, verzinkt</p> <p>snap-hook made from steel acc. C-DIN 5299 with thimble, zinc plated</p> | 245-K-120x11 | 121 | 17 | 17 | 18,8 |
| | 245-K-100x10 | 98 | 11 | 12 | 12,6 |
| | 245-K-80x8 | 80 | 9 | 11 | 6,4 |
| | 245-K-60x6 | 60 | 8 | 8 | 2,6 |
| | 245-K-50x5 | 50 | 6 | 7 | 1,6 |
| 245-S | | | | | |
| <p>Karabinerhaken aus Stahl ähnl. C-DIN 5299 mit Schraubverschluss, verzinkt</p> <p>snap hook made from steel acc. C-DIN 5299 with safety screw, zinc plated</p> | 245-S-180x14 | 180 | 19 | 30 | 46,4 |
| | 245-S-160x13 | 158 | 17 | 25 | 35,0 |
| | 245-S-140x12 | 139 | 15 | 18 | 25,8 |
| | 245-S-120x11 | 118 | 14 | 17 | 18,2 |
| | 245-S-100x10 | 100 | 12 | 11 | 12,4 |
| | 245-S-80x8 | 80 | 8 | 8 | 6,5 |
| | 245-S-70x7 | 70 | 6 | 7 | 4,2 |
| 245-S-60x6 | 60 | 6 | 6 | 3,0 | |
| 246 | | | | | |
| <p>Karabinerhaken aus Stahl ähnl. B-DIN 5299, verzinkt</p> <p>snap-hook made from steel acc. B-DIN 5299, zinc plated</p> | 246-140x12 | 140 | | 19 | 24,0 |
| | 246-120x11 | 120 | | 15 | 18,0 |
| | 246-100x10 | 98 | | 15 | 12,1 |
| | 246-80x8 | 78 | | 12 | 6,0 |
| | 246-70x7 | 70 | | 9 | 4,5 |
| 246-60x6 | 60 | | 7 | 2,6 | |
| 5001-1/2 | | | | | |
| <p>Karabinerhaken aus Stahldraht ähnl. A-DIN 5299, vernickelt</p> <p>snap-hook made from steel wire acc. A-DIN 5299, nickel plated</p> | 5001-1/2-70 | 71 | 10 | 9 | 2,4 |
| | 5001-1/2-60 | 61 | 8 | 7 | 1,8 |
| | 5001-1/2-50 | 50 | 7 | 5 | 0,9 |
| | 5001-1/2-40 | 42 | 6 | 7 | 0,6 |
| 5001 | | | | | |
| <p>Karabinerhaken aus Stahldraht mit eingehängtem Wirbel, vernickelt</p> <p>snap-hook made from steel wire with fitted swivel, nickel plated</p> | 5001-70 | 70 | 16 | 9 | 3,0 |
| | 5001-60 | 60 | 16 | 8 | 2,3 |
| | 5001-50 | 50 | 12 | 7 | 1,5 |
| | 5001-40 | 43 | 12 | 7 | 0,8 |
| 5002 | | | | | |
| <p>Karabinerhaken aus Stahldraht mit drehbarem Wirbel, vernickelt</p> <p>snap-hook made from steel wire with movable swivel, nickel plated</p> | 5002-70 | 66 | 14 | 7 | 1,9 |
| | 5002-60 | 60 | 14 | 6 | 1,5 |
| | 5002-50 | 54 | 14 | 5 | 0,9 |
| | 5002-40 | 44 | 12 | 4 | 0,6 |
| 5003 | | | | | |
| <p>Karabinerhaken aus Stahldraht mit drehbarem Wirbel, vernickelt</p> <p>snap-hook made from steel wire with movable swivel, nickel plated</p> | 5003-70 | 67 | 24 | 7 | 2,1 |
| | 5003-60 | 60 | 20 | 6 | 1,6 |
| | 5003-50 | 49 | 20 | 6 | 0,8 |
| | 5003-40 | 40 | 18 | 5 | 0,5 |

Karabinerhaken aus Stahl
snap-hooks made from steel

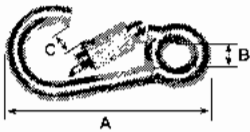



D = Gewicht (kg) bei 100 Stück
 weight (kgs) per 100 pieces

Alle Maße in mm
 all measurements in mm

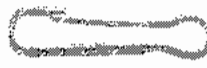
| Art.-Nr. / item no. 5287 | Art.-Nr. / item no. | A | B | C | D |
|---|---------------------|-----|----|-----|-----|
|  <p>Simplexhaken aus Stahldraht ähnl. DIN 5287, vernickelt simplex-hook made from steel wire acc. DIN 5287, nickel plated</p> | 5287-100 | 101 | 12 | 14 | 6,5 |
| | 5287-80 | 79 | 10 | 12 | 2,6 |
| | 5287-60 | 61 | 10 | 8 | 1,2 |
| | 5287-50 | 53 | 6 | 8 | 0,7 |
| | 5287-45 | 49 | 6 | 8 | 0,6 |
| | 5287-40 | 43 | 6 | 7 | 0,4 |
| | 5287-35 | 38 | 6 | 6 | 0,3 |
| | 5287-30 | 32 | 6 | 5 | 0,3 |
| 5287-25 | 27 | 6 | 5 | 0,1 | |

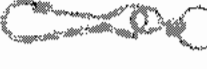
| Art.-Nr. / item no. 5287-T | Art.-Nr. / item no. | A | B | C | D |
|--|---------------------|----|---|---|-----|
|  <p>Tennis-Simplexhaken aus Stahldraht ähnl. DIN 5287, verzinkt tennis-simplex-hook made from steel wire acc. DIN 5287, zinc plated</p> | 5287-T-60 | 67 | 7 | 8 | 0,8 |

| Art.-Nr. / item no. 5287-W | Art.-Nr. / item no. | A | B | C | D |
|---|---------------------|-----|----|-----|-----|
|  <p>Simplexhaken aus Stahldraht ähnl. DIN 5287 mit eingehängtem Wirbel, vernickelt simplex-hook made from steel wire acc. DIN 5287 with fitted swivel, nickel plated Länge = Gesamtlänge mit Wirbel ohne Wirbel siehe Artikel 5287 length = outside length with swivel without swivel see item 5287</p> | 5287-W-100 | 155 | 16 | 16 | 8,0 |
| | 5287-W-80 | 124 | 20 | 10 | 4,6 |
| | 5287-W-60 | 86 | 12 | 8 | 1,4 |
| | 5287-W-50 | 82 | 12 | 8 | 1,1 |
| | 5287-W-45 | 85 | 12 | 8 | 1,0 |
| | 5287-W-40 | 70 | 10 | 8 | 0,8 |
| | 5287-W-35 | 67 | 12 | 6 | 0,7 |
| | 5287-W-30 | 57 | 12 | 4 | 0,4 |
| 5287-W-25 | 53 | 7 | 4 | 0,3 | |

| Art.-Nr. / item no. 689 | Art.-Nr. / item no. | A | B | C | D |
|--|---------------------|-----|----|----|-------|
|  <p>Ösenhaken aus Stahl ähnl. DIN 689, verzinkt eye-hook made from steel acc. DIN 689, zinc plated</p> | 689-2500 | 225 | 31 | 44 | 292,0 |
| | 689-1600 | 165 | 21 | 38 | 120,8 |
| | 689-1000 | 163 | 19 | 34 | 86,8 |
| | 689-600 | 116 | 15 | 24 | 33,5 |
| | 689-250 | 90 | 12 | 17 | 14,6 |

| Art.-Nr. / item no. 889-S | Art.-Nr. / item no. | A | B | C | D |
|--|---------------------|-----|----|----|-------|
|  <p>Ösenhaken aus Stahl ähnl. DIN 689 mit Sicherung, verzinkt eye-hook made from steel acc. DIN 689 with safety function, zinc plated</p> | 889-S-2500 | 234 | 25 | 43 | 301,5 |
| | 889-S-1600 | 185 | 22 | 37 | 128,2 |
| | 889-S-1000 | 163 | 19 | 25 | 86,5 |
| | 889-S-600 | 116 | 15 | 18 | 35,1 |
| | 889-S-250 | 89 | 11 | 13 | 16,7 |

| Art.-Nr. / item no. 734S | Art.-Nr. / item no. | A | B | C | D |
|--|---------------------|----|----|---|-----|
|  <p>Simplexhaken aus Stahldraht mit eingehängtem Wirbel, vernickelt simplex-hook made from steel wire with fitted swivel, nickel plated</p> | 734S-1" | 70 | 25 | 8 | 1,0 |
| | 734S-3/4" | 70 | 20 | 8 | 0,8 |
| | 734S-5/8" | 70 | 16 | 8 | 0,6 |

Karabinerhaken aus Stahl
snap-hooks made from steel

D = Gewicht (kg) bei 100 Stück
weight (kg) per 100 pieces

Alle Maße in mm
all measurements in mm

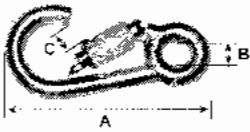

| Art.-Nr. / item no. | Art.-Nr. / item-no. | A | B | C | D |
|---------------------|---------------------|---|---|---|---|
| 734T | | | | | |

Simplerhaken aus Stahldraht
mit eingehängtem Wirbel,
vernickelt

734T-3/8"

55 10 6 0,3



simplex-hook made from steel wire
with fitted swivel, nickel plated

| Art.-Nr. / item no. | Art.-Nr. / item-no. | A | B | C | D |
|---------------------|---------------------|---|---|---|---|
| FAD | | | | | |

Mini-Simplerhaken aus
Stahldraht, vernickelt

FAD 153

13 3 3 0,01



mini-simplex-hook made from steel wire,
nickel plated

Karabinerhaken aus Messing
snap-hooks made from solid brass

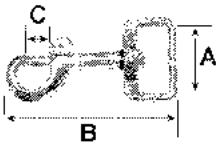

D = Gewicht (kg) bei 100 Stück
weight (kgs) per 100 pieces

Alle Maße in mm
all measurements in mm

| Art.-Nr. / item no. | Art.-Nr. / item no. | A | B | C | D |
|---------------------|---------------------|---|---|---|---|
|---------------------|---------------------|---|---|---|---|



Karabinerhaken aus Messing mit drehbarem Wirbel
snap-hook made from solid brass with movable swivel

| | | | | | |
|--|-----------------------|---------------|---------------|---------------|----------------|
| | 017-B-1" | 25 | 78 | 11 | 6,5 |
| | 017-B-3/4" | 20 | 76 | 10 | 6,7 |
| | 017-B-5/8" | 16 | 73 | 10 | 5,4 |

| Art.-Nr. / item no. | Art.-Nr. / item no. | A | B | C | D |
|---------------------|---------------------|---|---|---|---|
|---------------------|---------------------|---|---|---|---|



Karabinerhaken aus Messing mit drehbarem Wirbel
snap-hook made from solid brass with movable swivel

| | | | | | |
|--|------------------------|---------------|---------------|--------------|----------------|
| | 0170-B-3/4" | 20 | 75 | 8 | 3,9 |
| | 0170-B-5/8" | 16 | 74 | 8 | 3,7 |

| Art.-Nr. / item no. | Art.-Nr. / item no. | A | B | C | D |
|---------------------|---------------------|---|---|---|---|
|---------------------|---------------------|---|---|---|---|



Karabinerhaken aus Messing mit fester Öse
snap-hook made from solid brass with fixed eye

| | | | | | |
|--|------------|----|----|---|-----|
| | 100-B-3/4" | 20 | 53 | 8 | 3,8 |
|--|------------|----|----|---|-----|

| Art.-Nr. / item no. | Art.-Nr. / item no. | A | B | C | D |
|---------------------|---------------------|---|---|---|---|
|---------------------|---------------------|---|---|---|---|



Karabinerhaken aus Messing mit beidseitigem Schnäpper
double and half snap made from solid brass

| | | | | | |
|--|------------------|---------------|----------------|---------------|----------------|
| | 162-B | | 102 | 11 | 6,0 |
| | 161-B | 81 | 111 | 11 | 4,8 |

| Art.-Nr. / item no. | Art.-Nr. / item no. | A | B | C | D |
|---------------------|---------------------|---|---|---|---|
|---------------------|---------------------|---|---|---|---|



Panikhaken aus Messing mit drehbarem Wirbel
panic snap made from solid brass with movable swivel

| | | | | | |
|--|--------------------------|---------------|---------------|---------------|----------------|
| | 2002-B-1" R | 25 | 81 | 13 | 8,8 |
| | 2002-B-3/4" R | 20 | 82 | 11 | 8,8 |

| Art.-Nr. / item no. | Art.-Nr. / item no. | A | B | C | D |
|---------------------|---------------------|---|---|---|---|
|---------------------|---------------------|---|---|---|---|



Panikhaken aus Messing mit drehbarem Wirbel
panic snap made from solid brass with movable swivel

| | | | | | |
|--|---------------------------|---------------|---------------|---------------|----------------|
| | 2002-B-1" SQ | 25 | 84 | 12 | 10,5 |
| | 2002-B-3/4" SQ | 20 | 81 | 12 | 9,5 |

| Art.-Nr. / item no. | Art.-Nr. / item no. | A | B | C | D |
|---------------------|---------------------|---|---|---|---|
|---------------------|---------------------|---|---|---|---|



Karabinerhaken aus Messing mit drehbarem Wirbel
snap hook made from solid brass with movable swivel

| | | | | | |
|--|-----------------------|---------------|---------------|---------------|----------------|
| | 225-B-1" | 25 | 90 | 11 | 6,7 |
| | 225-B-3/4" | 20 | 84 | 12 | 5,6 |
| | 225-B-5/8" | 16 | 83 | 12 | 5,2 |

| Art.-Nr. / item no. | Art.-Nr. / item no. | A | B | C | D |
|---------------------|---------------------|---|---|---|---|
|---------------------|---------------------|---|---|---|---|

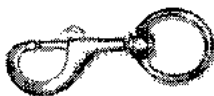

Karabinerhaken aus Messing mit drehbarem Wirbel
snap-hook made from solid brass with movable swivel





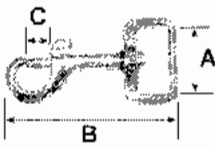



| | | | | | |
|--|------------------------|---------------|----------------|---------------|----------------|
| | 225-HB-1 1/8" | 28 | 115 | 15 | 10,7 |
| | 225-HB-7/8" | 22 | 101 | 11 | 8,2 |

Karabinerhaken aus Messing snap-hooks made from solid brass



D = Gewicht (kg) bei 100 Stück
weight (kgs) per 100 pieces

Alle Maße in mm
all measurements in mm

| Art.-Nr. / item no. | Art.-Nr. / item no. | A | B | C | D | |
|---|--|---------------|----|-----|----|------|
| 249-B | Karabinerhaken aus Messing mit fester Öse snap-hook made from solid brass with fixed eye | * 248-B-3/4" | 20 | 84 | 10 | 7,9 |
|  | | * 249-B-5/8" | 18 | 69 | 9 | 4,4 |
| | | * 248-B-3/8" | 10 | 54 | 7 | 3,0 |
| 251-B | Karabinerhaken aus Messing mit drehbarem Wirbel snap-hook made from solid brass with movable swivel | 251-B-3-7/8" | 22 | 112 | 15 | 12,5 |
|  | | 251-B-2-3/4" | 20 | 92 | 11 | 8,3 |
| | | 251-B-1-5/8" | 16 | 83 | 8 | 6,3 |
| 3002-B | Karabinerhaken aus Messing mit Drehverschluß und drehbarem Wirbel snap-hook made from solid brass with rotary closure and movable swivel | 3002-B-1" R | 26 | 100 | 21 | 14,5 |
|  | | 3002-B-3/4" R | 20 | 100 | 20 | 14,5 |
| 340-B | Karabinerhaken aus Messing mit Blattfeder und fester Öse snap-hook made from solid brass with flat spring and fixed eye | 340-B-3/4" | 20 | 43 | 5 | 1,1 |
|  | | 340-B-5/8" | 16 | 43 | 6 | 0,7 |
| | | 340-B-1/2" | 12 | 43 | 6 | 0,7 |
| 3726-B | Karabinerhaken aus Messing mit fester Öse snap-hook made from solid brass with fixed eye | * 3726-B-1" | 25 | 68 | 10 | 3,8 |
|  | | * 3726-B-3/4" | 20 | 64 | 7 | 3,7 |
| | | * 3726-B-5/8" | 16 | 62 | 7 | 3,6 |
| 4878-B | Karabinerhaken aus Messing mit drehbarem Wirbel snap-hook made from solid brass with movable swivel | 4878-B-3/4" | 20 | 83 | 10 | 6,8 |
|  | | | | | | |
| 5013-B | Karabinerhaken aus Messing mit drehbarem Wirbel snap-hook made from solid brass with movable swivel | 5013-B-5/8" | 18 | 68 | 15 | 3,7 |
|  | | 5013-B-1/2" | 12 | 65 | 13 | 3,3 |
| 5015-B | Karabinerhaken aus Messing mit drehbarem Wirbel snap-hook made from solid brass with movable swivel | 5015-B-3/4" | 20 | 84 | 11 | 3,7 |
|  | | 5015-B-5/8" | 16 | 68 | 11 | 3,2 |

Karabinerhaken aus Messing
snap-hooks made from solid brass

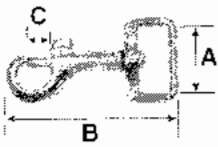

D = Gewicht (kg) bei 100 Stück
weight (kg) per 100 pieces

Alle Maße in mm
All measurements in mm

| Art.-Nr. / item no. 5025-B | | Art.-Nr. / item no. | A | B | C | D |
|--|--|------------------------|---------------|---------------|--------------|----------------|
|  Karabinerhaken aus Messing mit drehbarem Wirbel <i>snap-hook made from solid brass with movable swivel</i> | | 5025-B-3/4" | 20 | 84 | 8 | 4,5 |
| | | 5025-B-5/8" | 16 | 80 | 9 | 3,7 |
| | | 5025-B-1/2" | 12 | 78 | 9 | 3,3 |
| | | 5025-B-3/8" | 10 | 76 | 9 | 3,3 |

| Art.-Nr. / item no. 5578-B | | Art.-Nr. / item no. | A | B | C | D |
|--|--|---------------------|----|----|---|-----|
|  Karabinerhaken aus Messing mit drehbarem Wirbel <i>snap-hook made from solid brass with movable swivel</i> | | 5578-B-3/8" | 10 | 50 | 5 | 1,2 |

Karabinerhaken aus Edelstahl
snap-hooks made from stainless steel

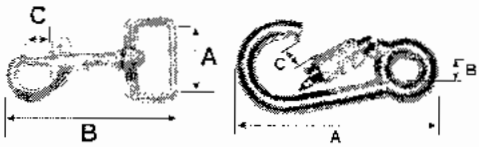

D = Gewicht (kg) bei 100 Stück
weight (kg) per 100 pieces

Alle Maße in mm
all measurements in mm

| Art.-Nr. / item no. | Art.-Nr. / item no. | A | B | C | D |
|---------------------|---------------------|---|---|---|---|
|---------------------|---------------------|---|---|---|---|

| | | | | | | |
|--|---|---------------|-----|--|----|-----|
| 163-I  | Karabinerhaken mit beidseitigem Schnäpper a. Edelstahl AISI 316 | 163-I-4 3/4" | 121 | | 12 | 7,4 |
| | <i>double end bolt snap made from stainless steel AISI 316</i> | 163-I-4 3/16" | 109 | | 9 | 5,9 |

| Art.-Nr. / item no. | Art.-Nr. / item no. | A | B | C | D |
|---------------------|---------------------|---|---|---|---|
|---------------------|---------------------|---|---|---|---|

| | | | | | | |
|--|---|--------------|----|-----|----|------|
| 225-I  | Karabinerhaken mit drehbarem Wirbel aus Edelstahl AISI 316 | 225-I-1 1/4" | 31 | 123 | 13 | 12,2 |
| | <i>snap-hook with movable swivel made from stainless steel AISI 316</i> | 225-I-1 1/8" | 29 | 105 | 13 | 7,6 |
| | | 225-I-3/4" | 20 | 91 | 10 | 4,8 |
| | | 225-I-5/8" | 18 | 81 | 11 | 5,2 |
| | | 225-I-1/2" | 12 | 68 | 10 | 5,0 |

| Art.-Nr. / item no. | Art.-Nr. / item no. | A | B | C | D |
|---------------------|---------------------|---|---|---|---|
|---------------------|---------------------|---|---|---|---|

| | | | | | | |
|---|---|------------|----|----|----|------|
| 2315-I  | Karabinerhaken mit fester Öse aus Edelstahl AISI 316 | 2315-I-100 | 66 | 14 | 21 | 14,2 |
| | <i>snap-hook with fixed ring made from stainless steel AISI 316</i> | 2315-I-70 | 67 | 8 | 16 | 4,7 |
| | | 2315-I-50 | 48 | 6 | 11 | 2,0 |

| Art.-Nr. / item no. | Art.-Nr. / item no. | A | B | C | D |
|---------------------|---------------------|---|---|---|---|
|---------------------|---------------------|---|---|---|---|

| | | | | | | |
|--|--|--------------|-----|----|-----|------|
| 245-I  | Karabinerhaken ähnl. C-DIN 5299 aus Edelstahl AISI 316 | 245-I-160x13 | 158 | 20 | 28 | 33,7 |
| | <i>snap-hook ähnl. C-DIN 5299 made from stainless steel AISI 316</i> | 245-I-140x12 | 138 | 14 | 24 | 25,7 |
| | | 245-I-120x11 | 120 | 12 | 14 | 19,1 |
| | | 245-I-100x10 | 101 | 11 | 11 | 13,1 |
| | | 245-I-80x8 | 80 | 13 | 8 | 8,3 |
| | | 245-I-70x7 | 70 | 11 | 8 | 4,9 |
| | | 245-I-60x6 | 60 | 7 | 8 | 2,5 |
| | | 245-I-50x5 | 50 | 6 | 8 | 1,8 |
| | 245-I-40x4 | 40 | 4 | 7 | 0,6 | |

| Art.-Nr. / item no. | Art.-Nr. / item no. | A | B | C | D |
|---------------------|---------------------|---|---|---|---|
|---------------------|---------------------|---|---|---|---|

| | | | | | | |
|---|---|---------------|-----|----|-----|------|
| 245-IK  | Karabinerhaken mit Kauache ähnl. C-DIN 5299 aus Edelstahl AISI 316 | 245-IK-120x11 | 121 | 15 | 18 | 19,1 |
| | <i>snap-hook with thimble ähnl. C-DIN 5299 made from stainless steel AISI 316</i> | 245-IK-100x10 | 99 | 13 | 13 | 12,8 |
| | | 245-IK-80x8 | 79 | 10 | 10 | 6,1 |
| | | 245-IK-60x6 | 60 | 6 | 8 | 2,3 |
| | 245-IK-50x5 | 50 | 7 | 7 | 1,5 | |

| Art.-Nr. / item no. | Art.-Nr. / item no. | A | B | C | D |
|---------------------|---------------------|---|---|---|---|
|---------------------|---------------------|---|---|---|---|

| | | | | | | |
|---|--|---------------|-----|----|----|------|
| 245-IS  | Karabinerhaken mit Schraubverschluß ähnl. C-DIN 5299 a. Edelstahl AISI 316 | 245-IS-120x11 | 120 | 12 | 14 | 18,3 |
| | <i>snap-hook with safety screw ähnl. C-DIN 5299 made from stainless steel AISI 316</i> | 245-IS-100x10 | 100 | 13 | 11 | 12,8 |
| | | 245-IS-80x8 | 80 | 10 | 8 | 6,4 |
| | | 245-IS-60x6 | 60 | 6 | 8 | 2,6 |

| Art.-Nr. / item no. | Art.-Nr. / item no. | A | B | C | D |
|---------------------|---------------------|---|---|---|---|
|---------------------|---------------------|---|---|---|---|

| | | | | | | |
|--|---|-------------|-----|----|----|------|
| 251-I  | Karabinerhaken mit drehbarem Wirbel aus Edelstahl AISI 316 | 251-I-3-117 | 118 | 20 | 14 | 14,3 |
| | <i>snap-hook with movable swivel made from stainless steel AISI 316</i> | 251-I-2-96 | 96 | 20 | 11 | 8,9 |

Karabinerhaken aus Edelstahl
 snap-hooks made from stainless steel



D = Gewicht (kg) bei 100 Stück
 weight (kgs) per 100 pieces

Alle Maße in mm
 all measurements in mm

| Art.-Nr. / item no. | Art.-Nr. / item no. | A | B | C | D |
|---------------------|---------------------|---|---|---|---|
|---------------------|---------------------|---|---|---|---|



**Karabinerhaken mit drehbarem
 Wirbel aus Edelstahl AISI 316**

snap-hook with movable swivel
 made from stainless steel AISI 316

4979-I-3/4"

| | | | |
|----|----|----|-----|
| 20 | 95 | 14 | 7,5 |
|----|----|----|-----|

| Art.-Nr. / item no. | Art.-Nr. / item no. | A | B | C | D |
|---------------------|---------------------|---|---|---|---|
|---------------------|---------------------|---|---|---|---|



**Karabinerhaken mit drehbarem
 Wirbel aus Edelstahl AISI 316**

snap-hook with movable swivel
 made from stainless steel AISI 316

5025-I-3/4"

| | | | |
|----|----|----|-----|
| 20 | 88 | 10 | 4,0 |
|----|----|----|-----|

5025-I-1/2"

| | | | |
|----|----|---|-----|
| 13 | 82 | 9 | 3,6 |
|----|----|---|-----|

| Art.-Nr. / item no. | Art.-Nr. / item no. | A | B | C | D |
|---------------------|---------------------|---|---|---|---|
|---------------------|---------------------|---|---|---|---|

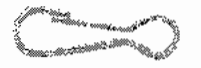

**Simplexhaken aus
 Edelstahl AISI 316**

simplex-hooks made from
 stainless steel AISI 316

5287-I-50

| | | | |
|----|---|---|-----|
| 50 | 9 | 6 | 0,3 |
|----|---|---|-----|

5287-I-40

| | | | |
|----|---|---|-----|
| 40 | 7 | 6 | 0,4 |
|----|---|---|-----|

| Art.-Nr. / item no. | Art.-Nr. / item no. | A | B | C | D |
|---------------------|---------------------|---|---|---|---|
|---------------------|---------------------|---|---|---|---|



**Karabinerhaken mit
 Schraubverschluss aus Edelstahl
 AISI 304**

snap-hook with safety screw
 made from stainless steel AISI 304

SKH-I-70

| | | | |
|----|---|----|-----|
| 71 | 3 | 11 | 0,8 |
|----|---|----|-----|

SKH-I-60

| | | | |
|----|---|---|-----|
| 59 | 4 | 7 | 0,7 |
|----|---|---|-----|

SKH-I-50

| | | | |
|----|---|---|-----|
| 50 | 3 | 5 | 0,5 |
|----|---|---|-----|

Karabinerhaken aus Aluminium
snap-hooks made from aluminium

D = Gewicht (kg) bei 100 Stück
weight (kgs) per 100 pieces

Alle Maße in mm
all measurements in mm

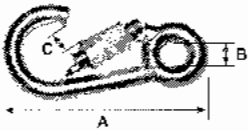

| Art.-Nr. / item no. | Art.-Nr. / item-no. | A | B | C | D |
|---------------------|---------------------|---|---|---|---|
| 228 | | | | | |

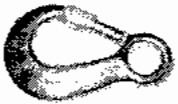

Karabinerhaken aus Aluminium mit Schraubverschluss

snap-hook made from aluminium with safety screw

| | | | | |
|------------|-----|----|----|------|
| 228 | 134 | 22 | 22 | 16,8 |
|------------|-----|----|----|------|

| Art.-Nr. / item no. | Art.-Nr. / item-no. | A | B | C | D |
|---------------------|---------------------|---|---|---|---|
| 229 F | | | | | |



Karabinerhaken aus Aluminium

snap-hook made from aluminium

| | | | | |
|--------------|-----|----|----|------|
| 229 F | 134 | 22 | 24 | 16,8 |
|--------------|-----|----|----|------|

| Art.-Nr. / item no. | Art.-Nr. / item-no. | A | B | C | D |
|---------------------|---------------------|---|---|---|---|
| 2490 | | | | | |



Karabinerhaken aus Aluminium, verfügbar in den Farben blau, grün, rot

snap-hooks made from aluminium, available in color blue, green, red

| | | | | |
|------------------|------|--|------|-----|
| 2490-80x8 | 78,6 | | 15,9 | 1,9 |
| 2490-80x6 | 59,0 | | 12,6 | 0,8 |
| 2490-50x5 | 49,6 | | 10,3 | 0,5 |

| Art.-Nr. / item no. | Art.-Nr. / item-no. | A | B | C | D |
|---------------------|---------------------|---|---|---|---|
| 2490-AL2 | | | | | |

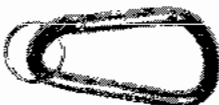

Karabinerhaken aus Aluminium, mit Schlüsselring, Farbe: blau

snap-hooks made from aluminium, with key-ring, color: blue

| | | | | |
|----------------------|------|------|------|-----|
| 2490-AL2-80x8 | 78,7 | 21,6 | 17,8 | 2,4 |
|----------------------|------|------|------|-----|

| Art.-Nr. / item no. | Art.-Nr. / item-no. | A | B | C | D |
|---------------------|---------------------|---|---|---|---|
| 72-S-2200 KP | | | | | |



Karabinerhaken aus Aluminium mit mit Schraubverschluss, Farbe: blau

snap-hook made from aluminium with safety screw, color: blue

| | | | | |
|---------------------|-----|--|----|-----|
| 72-S-2200 KP | 100 | | 18 | 5,6 |
|---------------------|-----|--|----|-----|

| Art.-Nr. / item no. | Art.-Nr. / item-no. | A | B | C | D |
|---------------------|---------------------|---|---|---|---|
| 72-S-24 KN | | | | | |



Karabinerhaken aus Aluminium mit Schraubverschluss, Farbe: silber

snap-hook made from aluminium with safety screw, color: silver

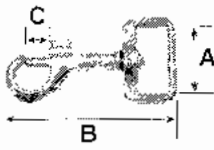

| | | | | |
|-------------------|-----|--|----|-----|
| 72-S-24 KN | 100 | | 18 | 5,0 |
|-------------------|-----|--|----|-----|

Karabinerhaken aus Plastik
snap-hooks made from plastic



D = Gewicht (kg) bei 100 Stück
 weight (kgs) per 100 pieces

Alle Maße in mm
 all measurements in mm

| Art.-Nr. / item no. A2 | Art.-Nr. / item no. | A | B | C | D |
|---|---------------------|-----------------|-----------------|----------------|----------------|
|  Karabinerhaken aus Plastik mit beweglicher Öse snap-hook made from plastic with movable eye | A2-40 | 38,8 | 57,6 | 6,0 | 0,7 |
| | A2-30 | 32,6 | 57,6 | 8,0 | 0,6 |
| | A2-25 | 28,0 | 58,0 | 5,5 | 0,5 |
| | A2-20 | 21,3 | 57,0 | 5,1 | 0,3 |
| Art.-Nr. / item no. A6 | Art.-Nr. / item no. | A | B | C | D |
|  Karabinerhaken aus Plastik snap-hook made from plastic | A6-6 | 9,0 | 73,0 | 9,4 | 1,2 |
| | A6-5 | 5,8 | 48,7 | 8,5 | 0,6 |

Ringe aus Stahl
rings made from steel

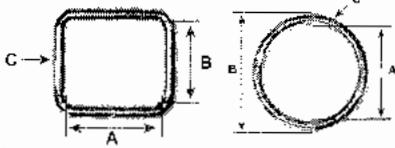

D = Gewicht (kg) bei 100 Stück
weight (kgs) per 100 pieces

Alle Maße in mm
all measurements in mm

| Art.-Nr. / item no. | Art.-Nr. / item no. | A | B | C | D |
|---------------------|---------------------|---|---|---|---|
|---------------------|---------------------|---|---|---|---|

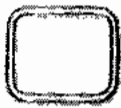

Vierkentring geschweißt aus Stahl, vernickelt

square ring welded made from steel, nickel plated

* 0392-7/8"x1"

25,9 21,9 3,8 1,0

| Art.-Nr. / item no. | Art.-Nr. / item no. | A | B | C | D |
|---------------------|---------------------|---|---|---|---|
|---------------------|---------------------|---|---|---|---|



Ösenring mit Plastikgriff, verzinkt

eye ring with plastic hold, zinc plated

10-10x145

140 165 8,8 32,5

| Art.-Nr. / item no. | Art.-Nr. / item no. | A | B | C | D |
|---------------------|---------------------|---|---|---|---|
|---------------------|---------------------|---|---|---|---|



D-Ring geschweißt aus Stahl, vernickelt

D ring welded made from steel, nickel plated

256-50x7,0

50 39 6,8 4,9

258-45x6,6

45 35 6,1 3,6

256-40x5,0

39 30 4,9 2,1

* 256-35x5,0

35 28 4,8 1,6

* 256-30x3,8

29 21 3,7 0,8

* 256-27x3,6

26 20 3,5 0,7

256-25x4,0

25 22 3,7 0,8

* 256-25x3,4

26 18 3,3 0,6

256-25x3,0

25 18 2,9 0,4

* 256-22x3,2

21 16 3,2 0,5

* 256-20x3,0

20 15 3,0 0,4

* 256-18x2,8

17 14 2,8 0,3

* 256-16x2,6

16 12 2,5 0,2

* 256-14x2,4

13 11 2,2 0,2

* 256-12x2,2

12 10 2,1 0,1

* 256-10x2,1

10 8 2,1 0,1

| Art.-Nr. / item no. | Art.-Nr. / item no. | A | B | C | D |
|---------------------|---------------------|---|---|---|---|
|---------------------|---------------------|---|---|---|---|



Rundring geschweißt aus Stahl, verzinkt

round ring welded made from steel, zinc plated

258-80x12,0

82 106,2 12,1 27,0

258-80x8,0

80 88,0 8,0 11,5

258-70x8,0

70 86,0 8,0 9,6

258-60x12,0

61 84,2 11,6 19,4

258-60x9,0

59 78,2 9,6 12,4

258-60x8,0

60 76,4 8,2 8,0

258-60x6,0

59 70,8 5,9 4,5

258-50x12,0

49 73,0 12,0 18,1

258-50x10,0

49 68,6 9,8 11,2

258-50x7,0

50 64,0 7,0 6,5

258-50x6,0

49 62,0 6,5 4,6

258-50x5,0

50 70,0 5,0 2,8

258-45x10,0

45 65,0 10,0 11,1

258-45x9,0

45 63,0 9,0 8,7

258-45x8,0

45 62,0 7,9 6,3

258-45x6,6

45 68,2 6,6 4,0

258-40x10,0

39 69,2 10,1 10,0

256-40x8,0

42 60,0 8,0 8,0

258-45x6,6 = vernickelt / nickel plated

Ringe aus Stahl
rings made from steel

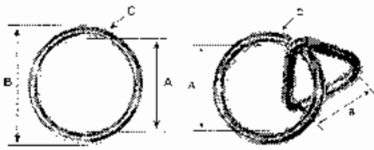

D = Gewicht (kg) bei 100 Stück
weight (kgs) per 100 pieces

Alle Maße in mm
all measurements in mm

| Art.-Nr. / item no. 258 | | Art.-Nr. / item no. | A | B | C | D |
|---|--|---------------------|----|------|-----|-----|
|  | Rundring geschweißt aus Stahl, vernickelt round ring welded made from steel, nickel plated | 258-40x8,0 | 39 | 54,6 | 7,8 | 5,4 |
| | | * 258-40x6,0 | 40 | 58,0 | 6,0 | 3,0 |
| | | ** 258-40x5,0 | 38 | 48,0 | 5,0 | 1,9 |
| | | * 258-40x4,0 | 40 | 47,8 | 3,9 | 1,2 |
| | | 258-36x5,0 | 35 | 45,0 | 5,0 | 1,8 |
| | | 258-35x7,0 | 34 | 48,0 | 7,0 | 3,5 |
| | | * 258-32x4,0 | 31 | 38,0 | 4,0 | 1,0 |
| | | * 258-31x4,5 | 30 | 38,8 | 4,3 | 1,1 |
| | | * 258-30x4,0 | 30 | 37,6 | 3,8 | 0,9 |
| | | * 258-27x3,7 | 27 | 34,4 | 3,7 | 0,8 |
| | | # 258-25x4,0 | 25 | 33,0 | 4,0 | 0,7 |
| | | * 258-25x3,5 | 25 | 31,2 | 3,1 | 0,5 |
| | | 258-25x3,0 | 24 | 30,0 | 3,0 | 0,4 |
| | | * 258-22x3,2 | 22 | 28,4 | 3,2 | 0,3 |
| | | 258-21x3,0 | 21 | 27,0 | 3,0 | 0,4 |
| | | * 258-20x3,0 | 20 | 26,0 | 3,0 | 0,4 |
| | | # 258-18x2,8 | 17 | 22,6 | 2,8 | 0,3 |
| | | * 258-18x2,8 | 16 | 20,8 | 2,7 | 0,2 |
| | | 258-16x2,5 | 16 | 21,0 | 2,4 | 0,2 |
| | | # 258-14x2,4 | 13 | 17,4 | 2,2 | 0,2 |
| | | 258-12x2,2 | 12 | 16,4 | 2,2 | 0,1 |

* = auch in verzinkt (ZP) lieferbar
* = also available in zinc plated (ZP)

258-10x8,0 / 258-35x7,0 = verzinkt / zinc plated
258-35x6,5 = vormassingt / brass plated

| Art.-Nr. / item no. 259 | | Art.-Nr. / item no. | A | B | C | D |
|---|---|---------------------|----|------|-----|------|
|  | Schlüsselring aus Stahl, vernickelt key ring made from steel, nickel plated | 259-50 | 43 | 48,6 | 3,3 | 1,2 |
| | | 259-38 | 33 | 37,4 | 2,2 | 0,5 |
| | | 259-35 | 30 | 34,4 | 2,2 | 0,5 |
| | | 259-30 | 26 | 30,2 | 2,1 | 0,3 |
| | | 259-28 | 24 | 28,2 | 2,1 | 0,3 |
| | | 259-26 | 22 | 26,2 | 2,1 | 0,3 |
| | | * 259-24 | 20 | 23,8 | 1,8 | 0,2 |
| | | 259-20 | 16 | 19,6 | 1,6 | 0,1 |
| | | 259-18 | 15 | 18,2 | 1,6 | 0,1 |
| | | 259-16 | 13 | 16,2 | 1,6 | 0,1 |
| | | 259-14 | 12 | 14,4 | 1,2 | 0,05 |
| | | 259-12 | 8 | 11,8 | 1,3 | 0,05 |
| | | 259-10 | 8 | 10,6 | 1,3 | 0,05 |

| Art.-Nr. / item no. 340 | | Art.-Nr. / item no. | A | B | C | D |
|---|--|---------------------|------|------|-----|-----|
|  | Schweinenasenring, verzinkt pig nose ring, zinc plated | 340-6,0x30 | 28,4 | 41,6 | 8,0 | 2,3 |

| Art.-Nr. / item no. 3610-ST | | Art.-Nr. / item no. | A | B | C | D |
|---|---|---------------------|------|------|-----|-----|
|  | Ring mit Triangel geschweißt aus Stahl, vernickelt ring with loop welded made from steel, nickel plated | * 3610-ST-1"x1 1/2" | 40,8 | 27,8 | 6,0 | 5,3 |

Ringe aus Stahl
rings made from steel

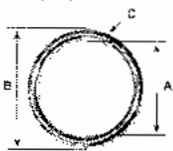

D = Gewicht (kg) bei 100 Stück
weight (kgs) per 100 pieces

Alle Maße in mm
all measurements in mm

| Art.-Nr. / item no. | Art.-Nr. / item no. | A | B | C | D |
|---------------------|---------------------|---|---|---|---|
|---------------------|---------------------|---|---|---|---|



Warenring mit Haken, aus
Stahldraht, verchromt
bridle ring with hook,
made of steel wire, nickel plated

| | | | | | |
|--|----------------------|-----------------|-----------------|----------------|----------------|
| | 943128-120 | 112,6 | 120,4 | 4,0 | 4,8 |
| | 943128-80 | 87,1 | 94,7 | 3,9 | 3,6 |

| Art.-Nr. / item no. | Art.-Nr. / item no. | A | B | C | D |
|---------------------|---------------------|---|---|---|---|
|---------------------|---------------------|---|---|---|---|



Warenring ohne Haken, aus
Stahldraht, verchromt
bridle ring without hook,
made of steel wire, nickel plated

| | | | | | |
|--|------------------------|-----------------|-----------------|----------------|----------------|
| | 943128-120 A | 117,0 | 125,4 | 4,0 | 3,8 |
| | 943128-80 A | 89,8 | 96,0 | 3,9 | 3,7 |

Ringe aus Messing
rings made from solid brass

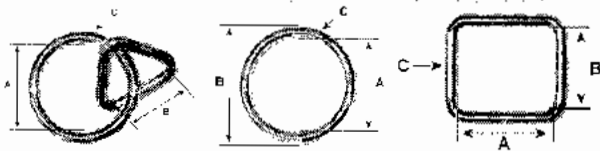

D = Gewicht (kg) bei 100 Stück
weight (kgs) per 100 pieces

Alle Maße in mm
all measurements in mm

| Art.-Nr. / item no. | Art.-Nr. / item no. | A | B | C | D |
|---------------------|---------------------|---|---|---|---|
|---------------------|---------------------|---|---|---|---|



Ring mit Triangel aus Messing

* 3610-B-1"

| | | | |
|------|------|-----|-----|
| 36,1 | 26,6 | 5,8 | 4,9 |
|------|------|-----|-----|

ring with loop welded made from
solid brass

| Art.-Nr. / item no. | Art.-Nr. / item no. | A | B | C | D |
|---------------------|---------------------|---|---|---|---|
|---------------------|---------------------|---|---|---|---|



D-Ring aus Messing

D-ring made from solid brass

| | | | | | |
|--|---------------------------|-----------------|-----------------|----------------|----------------|
| | * 452-B-1 1/2" | 38,8 | 28,6 | 4,7 | 2,0 |
| | * 452-B-1 1/4" | 31,8 | 25,1 | 5,0 | 1,8 |
| | * 452-B-1 1/8" | 29,2 | 26,7 | 4,1 | 1,3 |
| | * 452-B-1" | 25,7 | 22,9 | 3,8 | 1,1 |
| | * 452-B-7/8" | 22,8 | 18,9 | 4,0 | 0,9 |
| | * 452-B-3/4" | 18,8 | 15,8 | 3,0 | 0,5 |
| | * 452-B-5/8" | 16,3 | 15,8 | 2,8 | 0,4 |

| Art.-Nr. / item no. | Art.-Nr. / item no. | A | B | C | D |
|---------------------|---------------------|---|---|---|---|
|---------------------|---------------------|---|---|---|---|



Rundring aus Messing

round ring made from solid brass

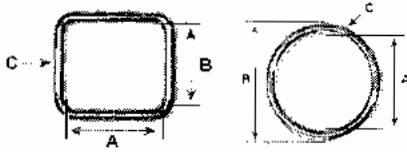

| | | | | | |
|--|-------------------------|-----------------|-----------------|----------------|----------------|
| | * 7-B-2" | 51,1 | 63,4 | 6,3 | 4,5 |
| | * 7-B-1 3/4" | 45,6 | 57,5 | 5,8 | 4,0 |
| | * 7-B-1 1/2" | 38,1 | 48,6 | 5,7 | 3,1 |
| | * 7-B-1 1/4" | 32,6 | 42,8 | 4,5 | 1,8 |
| | * 7-B-1 1/8" | 29,4 | 38,9 | 5,5 | 2,1 |
| | * 7-B-1" | 25,8 | 34,0 | 4,0 | 1,0 |
| | * 7-B-7/8" | 24,2 | 32,2 | 3,7 | 0,8 |
| | * 7-B-3/4" | 20,8 | 28,1 | 4,4 | 0,8 |
| | * 7-B-5/8" | 16,1 | 24,5 | 4,1 | 0,6 |
| | * 7-B-1/2" | 12,9 | 18,6 | 3,2 | 0,2 |

Ringe aus Edelstahl
rings made from stainless steel



D = Gewicht (kg) bei 100 Stück
weight (kg) per 100 pieces

Alle Maße in mm
all measurements in mm

| Art.-Nr. / item no. | | Art.-Nr. / item-no. | A | B | C | D |
|---------------------|--|---------------------|------|------|-----|-----|
| 256-I |  D-Ring aus Edelstahl AISI 316 D-ring made from stainless steel AISI 316 | 256-I-50x8 | 51,3 | 58,1 | 8,0 | 7,2 |
| | | 256-I-50x6 | 48,8 | 56,5 | 6,0 | 4,0 |
| | | 256-I-40x4 | 40,2 | 46,4 | 3,9 | 1,5 |
| | | 256-I-38x5 | 35,2 | 37,2 | 5,0 | 1,8 |
| | | 256-I-30x4 | 30,2 | 36,2 | 3,9 | 1,2 |
| | | 256-I-25x4 | 25,5 | 30,6 | 3,8 | 0,8 |
| | | 256-I-20x4 | 20,3 | 23,6 | 3,9 | 0,7 |
| | | 256-I-20x3 | 20,5 | 18,4 | 2,8 | 0,5 |
| 7-I |  Rundring aus Edelstahl AISI 316 round ring made from stainless steel AISI 316 | 7-I-70x8 | 70,0 | 86,0 | 8,0 | 9,8 |
| | | 7-I-60x6 | 68,7 | 89,7 | 5,0 | 3,1 |
| | | 7-I-50x8 | 50,7 | 66,5 | 8,0 | 7,3 |
| | | 7-I-50x6 | 50,3 | 62,3 | 6,0 | 3,9 |
| | | 7-I-45x8 | 45,2 | 61,2 | 8,0 | 6,5 |
| | | 7-I-40x6 | 40,8 | 59,0 | 5,8 | 3,3 |
| | | 7-I-40x5 | 41,3 | 51,1 | 4,8 | 2,1 |
| | | 7-I-40x4 | 41,7 | 48,7 | 3,9 | 1,3 |
| | | 7-I-35x4 | 35,3 | 43,1 | 3,9 | 1,1 |
| | | 7-I-30x4 | 30,2 | 38,5 | 3,8 | 0,9 |
| | | 7-I-25x4 | 25,3 | 33,4 | 3,9 | 0,7 |
| | | 7-I-20x3 | 20,2 | 28,2 | 2,8 | 0,5 |

Schnallen, Schieber, Schleifen aus Stahl, Zinkdruck- u. Temperguß
 buckles, slides, loops made from steel, zinc die cast and malleable cast iron

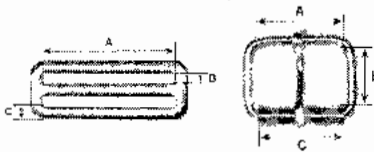

D = Gewicht (kg) bei 100 Stück
 weight (kgs) per 100 pieces

Alle Maße in mm
 all measurements in mm

| Art.-Nr. / item no. | Art.-Nr. / item no. | A | B | C | D |
|--|---------------------|------|------|-----|-----|
| 02120 | | | | | |
|  Schiebelschnalle gebogen aus Stahl, vernickelt riding buckle bent made from steel, nickel plated | 02120-28 | 27,8 | 11,8 | 4,6 | 2,0 |
| | 02120-25 | 28,0 | 8,2 | 4,2 | 1,1 |
| | 02120-20 | 20,5 | 8,2 | 4,4 | 0,9 |
| | 02120-17 | 17,0 | 6,8 | 4,0 | 0,8 |
| | 02120-15 | 14,0 | 5,8 | 3,4 | 0,5 |

| Art.-Nr. / item no. | Art.-Nr. / item no. | A | B | C | D |
|---|---------------------|------|-----|-----|-----|
| 1023-ST | | | | | |
|  Schieber aus Stahl, vernickelt slide made from steel, nickel plated | 1023-ST-1" | 28,0 | 8,0 | 3,8 | 0,8 |
| | 1023-ST-3/4" | 20,4 | 8,0 | 4,8 | 0,7 |

| Art.-Nr. / item no. | Art.-Nr. / item no. | A | B | C | D |
|---|---------------------|------|-----|-----|-----|
| 1375+2300 | | | | | |
|  Set für Deckengurt mit Schieber aus Stahl, vernickelt saddlery buckle with slide made from steel, nickel plated | 1375+2300-80 | 78,2 | 4,7 | 5,1 | 7,4 |
| | 1375+2300-50 | 50,7 | 3,7 | 4,8 | 5,1 |
| | 1375+2300-38 | 38,8 | 5,7 | 3,4 | 3,1 |

| Art.-Nr. / item no. | Art.-Nr. / item no. | A | B | C | D |
|--|---------------------|------|-----|-----|-----|
| 1375-ST | | | | | |
|  Deckengurtverschluß aus Stahl, vernickelt saddlery buckle made from steel, nickel plated | * 1375-ST-2"x3,0 | 50,5 | 5,7 | 4,8 | 3,2 |

| Art.-Nr. / item no. | Art.-Nr. / item no. | A | B | C | D |
|---|---------------------|------|-----|-----|-----|
| 2300-50 Hoch | | | | | |
|  Schieber aus Stahl, vernickelt slide made from steel, nickel plated | 2300-50 Hoch | 50,9 | 6,0 | 5,1 | 2,1 |

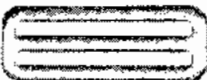
| Art.-Nr. / item no. | Art.-Nr. / item no. | A | B | C | D |
|---|---------------------|------|-----|-----|-----|
| 2300-ST | | | | | |
|  Schieber aus Stahl, vernickelt slide made from steel, nickel plated | 2300-ST-3" | 78,5 | 4,7 | 5,1 | 2,8 |
| | 2300-ST-2" | 50,7 | 3,7 | 4,8 | 2,1 |

| Art.-Nr. / item no. | Art.-Nr. / item no. | A | B | C | D |
|---|---------------------|------|-----|-----|------|
| 4690 | | | | | |
|  Schieber aus Stahl, vernickelt slide made from steel, nickel plated | 4690-0,9x20 | 19,8 | 4,8 | 1,7 | 0,05 |

| Art.-Nr. / item no. | Art.-Nr. / item no. | A | B | C | D |
|---|---------------------|------|-----|-----|-----|
| 4691 | | | | | |
|  Schieber aus Stahl, vernickelt slide made from steel, nickel plated | 4691-1,8x25 | 25,3 | 3,8 | 1,8 | 0,1 |

Schnallen, Schieber Schlaufen aus Stahl, Zinkdruck- u. Temperguß
buckles, slides, loops made from steel, zinc die cast and malleable cast iron

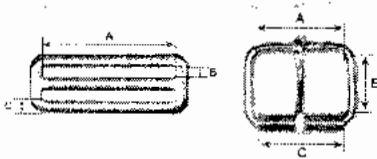

D = Gewicht (kg) bei 100 Stück
 weight (kgs) per 100 pieces

Alle Maße in mm
 all measurements in mm

| Art.-Nr. / item no. | Art.-Nr. / item no. | A | B | C | D |
|---------------------|---------------------|---|---|---|---|
|---------------------|---------------------|---|---|---|---|



1049-ST
 Rolleschnalle aus Stahl, vernickelt
roller buckle made from steel, nickel plated

1049-ST-1" 25,9 15,0 24,0 0,8

| Art.-Nr. / item no. | Art.-Nr. / item no. | A | B | C | D |
|---------------------|---------------------|---|---|---|---|
|---------------------|---------------------|---|---|---|---|



1407-W
 Rolleschnalle geschweißt aus Stahl, vernickelt
roller buckle welded made from steel, nickel plated

| | | | | |
|------------------|------|------|------|-----|
| 1407-30 W | 32,8 | 17,6 | 29,5 | 1,5 |
| 1407-27 W | 28,2 | 16,0 | 24,0 | 1,0 |
| 1407-25 W | 26,7 | 15,0 | 25,8 | 0,9 |
| 1407-20 W | 21,2 | 10,5 | 18,7 | 0,6 |
| 1407-18 W | 19,8 | 10,0 | 18,3 | 0,5 |
| 1407-16 W | 18,4 | 11,6 | 15,0 | 0,4 |
| 1407-14 W | 14,1 | 11,9 | 13,0 | 0,3 |
| 1407-12 W | 12,9 | 7,2 | 12,5 | 0,2 |
| 1407-10 W | 9,8 | 6,5 | 9,0 | 0,1 |

| Art.-Nr. / item no. | Art.-Nr. / item no. | A | B | C | D |
|---------------------|---------------------|---|---|---|---|
|---------------------|---------------------|---|---|---|---|



1440
 Rolleschnalle geschweißt aus Stahl, vernickelt
roller buckle welded made from steel, nickel plated

| | | | | |
|---------------------|------|------|------|-----|
| # 1440-50 | 52,6 | 29,8 | 48,0 | 5,6 |
| # 1440-40 | 39,8 | 24,3 | 36,0 | 3,8 |
| 1440-25 (ZP) | 27,0 | 18,6 | 25,1 | 2,5 |

| Art.-Nr. / item no. | Art.-Nr. / item no. | A | B | C | D |
|---------------------|---------------------|---|---|---|---|
|---------------------|---------------------|---|---|---|---|



1230-R
 Sattelschnalle aus Stahl, vernickelt
saddle buckle made from steel, nickel plated

1230-R-1" NP 27,6 43,0 24,2 3,8

| Art.-Nr. / item no. | Art.-Nr. / item no. | A | B | C | D |
|---------------------|---------------------|---|---|---|---|
|---------------------|---------------------|---|---|---|---|



147-Z
 Doppelstegschnalle aus Zinkdruckguß, vernickelt
double bar buckle made from zinc die cast, nickel plated

| | | | | |
|---------------------|------|------|--|-----|
| * 147-Z-1" | 26,0 | 36,8 | | 3,0 |
| * 147-Z-3/4" | 18,6 | 31,7 | | 1,8 |
| 147-Z-5/8" | 16,2 | 25,3 | | 1,2 |
| 147-Z-1/2" | 13,2 | 21,8 | | 1,0 |

| Art.-Nr. / item no. | Art.-Nr. / item no. | A | B | C | D |
|---------------------|---------------------|---|---|---|---|
|---------------------|---------------------|---|---|---|---|



210-Z
 Conwayschnalle aus Zinkdruckguß, vernickelt
Conway buckle made from zinc die cast, nickel plated

| | | | | |
|-------------------|------|------|--|-----|
| 210-Z-1" | 25,8 | 40,7 | | 2,1 |
| 210-Z-3/4" | 18,5 | 31,8 | | 0,7 |
| 210-Z-5/8" | 16,0 | 27,3 | | 0,6 |
| 210-Z-1/2" | 13,2 | 24,5 | | 0,5 |

| Art.-Nr. / item no. | Art.-Nr. / item no. | A | B | C | D |
|---------------------|---------------------|---|---|---|---|
|---------------------|---------------------|---|---|---|---|



260
 Schiebeschnalle für Halfter aus Stahl, vernickelt
half hitch slide buckle made from steel, nickel plated

*** 260** 25,9 7,5 14,0 2,7

Schnallen, Schieber, Schlaufen aus Stahl, Zinkdruck- u. Temperguß
buckles, slides, loops made from steel, zinc die cast and malleable cast iron

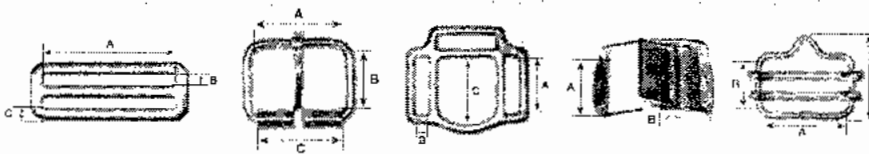

D = Gewicht (kg) bei 100 Stück
 weight (kgs) per 100 pieces

Alle Maße in mm
 all measurements in mm

| Art.-Nr. / item no. | Art.-Nr. / item no. | A | B | C | D |
|---------------------|---------------------|---|---|---|---|
|---------------------|---------------------|---|---|---|---|



Halfterring mit zwei Ösen aus Stahl, vernickelt

halter ring with two eyelets made from steel, nickel plated

* 270 26,5 5,0 31,8 3,1

| Art.-Nr. / item no. | Art.-Nr. / item no. | A | B | C | D |
|---------------------|---------------------|---|---|---|---|
|---------------------|---------------------|---|---|---|---|

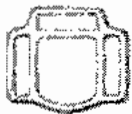

Halfterring mit drei Ösen aus Temper- u. Zinkdruckguß, vn.

halter ring with three eyelets made from malleable cast iron and zinc die cast, nickel plated

* 370-M-1" 27,5 6,2 31,6 4,5

~~* 370-Z-1" 26,1 6,6 29,6 6,6~~

| Art.-Nr. / item no. | Art.-Nr. / item no. | A | B | C | D |
|---------------------|---------------------|---|---|---|---|
|---------------------|---------------------|---|---|---|---|



Schnurengurtschnalle aus Stahl, vernickelt

buckle made from steel, nickel plated

2800-50 28,0 11,8 27,6 3,9

| Art.-Nr. / item no. | Art.-Nr. / item no. | A | B | C | D |
|---------------------|---------------------|---|---|---|---|
|---------------------|---------------------|---|---|---|---|



Breitbandverbinder aus Stahl, verzinkt

buckle made from steel, zinc plated

4960-40 38,6 22,7 39,7 2,0

~~4960-20 27,0 15,1 27,3 0,5~~

| Art.-Nr. / item no. | Art.-Nr. / item no. | A | B | C | D |
|---------------------|---------------------|---|---|---|---|
|---------------------|---------------------|---|---|---|---|



Schnalle aus Zinkdruckguß, vernickelt

buckle made from zinc die cast, nickel plated

5-Z-1" 26,2 32,0 42,6 2,7

5-Z-3/4" 22,0 23,6 32,6 1,2

5-Z-5/8" 17,6 20,7 28,7 0,8

5-Z-1/2" 13,1 17,6 28,7 0,6

| Art.-Nr. / item no. | Art.-Nr. / item no. | A | B | C | D |
|---------------------|---------------------|---|---|---|---|
|---------------------|---------------------|---|---|---|---|

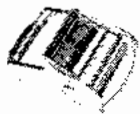

Klemmschloß aus Zinkdruckguß, verzinkt

cam buckle made from zinc die cast, zinc plated

5701-25 26,0 13,8 4,7

5702-25 25,8 12,2 3,2

5704-20 19,1 10,3 2,1

| Art.-Nr. / item no. | Art.-Nr. / item no. | A | B | C | D |
|---------------------|---------------------|---|---|---|---|
|---------------------|---------------------|---|---|---|---|



Schnalle aus Zinkdruckguß, vernickelt

buckle made from zinc die cast, nickel plated

* 5708-HZ-1" 26,6 47,8 64,5 4,8

Schnellen, Schieber Schleifen aus Stahl, Zinkdruck- u. Temperguß
buckles, slides, loops made from steel, zinc die cast and malleable cast iron

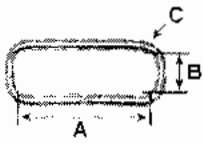

D = Gewicht (kg) bei 100 Stück
 weight (kg) per 100 pieces

Alle Maße in mm
 all measurements in mm

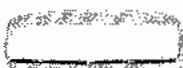
| Art.-Nr. / item no. | Art.-Nr. / item no. | A | B | C | D |
|---|---------------------|------|-----|-----|-----|
| 257  Schlaufe aus halbrundem Stahdraht ungeschweißt, vernickelt loop made from half-round steel wire, nickel plated | 257-40 | 40,7 | 9,2 | 4,0 | 0,3 |
| | 257-30 | 30,7 | 8,7 | 4,3 | 0,3 |
| | * 257-25 | 25,3 | 9,1 | 4,4 | 0,2 |
| | 257-22 | 22,8 | 9,4 | 4,4 | 0,2 |
| | * 257-20 | 20,5 | 9,0 | 4,4 | 0,2 |
| | 257-18 | 18,1 | 9,5 | 4,4 | 0,2 |
| | * 257-16 | 16,8 | 9,3 | 4,3 | 0,2 |
| | 257-14 | 14,6 | 8,2 | 4,6 | 0,1 |
| | * 257-12 | 12,8 | 9,2 | 4,4 | 0,1 |
| | 257-10 | 10,7 | 9,7 | 4,4 | 0,1 |

| Art.-Nr. / item no. | Art.-Nr. / item no. | A | B | C | D |
|--|---------------------|------|------|-----|-----|
| 257-H  Schlaufe (hoch) aus halbrundem Stahdraht ungeschweißt, vernickelt loop (high) made from half-round steel wire unwelded, nickel plated | 257-H-30 | 30,4 | 13,0 | 4,5 | 0,3 |
| | 257-H-25 | 26,4 | 14,8 | 4,4 | 0,2 |
| | 257-H-20 | 20,4 | 12,7 | 4,4 | 0,2 |
| | 257-H-18 | 18,2 | 12,8 | 4,3 | 0,2 |

| Art.-Nr. / item no. | Art.-Nr. / item no. | A | B | C | D |
|--|---------------------|------|------|-----|-----|
| 4950-ST  Schlaufe a. Stahl ungeschweißt, vernickelt loop made from steel unwelded, nickel plated | 4950-ST-1" | 27,2 | 9,5 | 2,4 | 0,2 |
| | 4950-ST-3/4" | 20,6 | 10,1 | 2,4 | 0,2 |
| | 4950-ST-5/8" | 18,6 | 13,1 | 2,0 | 0,1 |

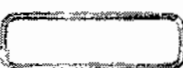

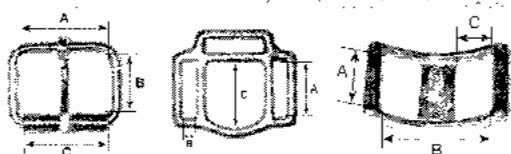

| Art.-Nr. / item no. | Art.-Nr. / item no. | A | B | C | D |
|--|---------------------|------|------|-----|-----|
| 4950-W  Schlaufe aus Stahl geschweißt, vernickelt loop made from steel welded, nickel plated | 4950-W-2" | 51,0 | 12,6 | 2,8 | 0,8 |

Schnallen aus Messing buckles made from solid brass



D = Gewicht (kg) bei 100 Stück
weight (kg) per 100 pieces

Alle Maße in mm
all measurements in mm

| Art.-Nr. / item no. | | Art.-Nr. / item-no. | A | B | C | D |
|---|--|---------------------|------|------|------|-----|
| 12-B | Geschirrschnalle aus Messing kitchen buckle made from solid brass | * 12-B-32 | 31,9 | 34,0 | | 3,7 |
|  | | * 12-B-25 | 25,2 | 29,8 | | 2,1 |
| | | * 12-B-20 | 20,0 | 25,5 | | 1,8 |
| | | * 12-B-16 | 16,0 | 19,8 | | 1,2 |
| | | * 12-B-14 | 14,0 | 16,0 | | 0,8 |
| | | * 12-B-12 | 12,0 | 16,0 | | 0,5 |
| 121-B | Stagschnalle aus Messing buckle made from solid brass | * 121-B-3/4" | 20,8 | 35,2 | | 1,4 |
|  | | * 121-B-5/8" | 17,5 | 29,2 | | 1,0 |
| | | * 121-B-1/2" | 13,2 | 26,6 | | 0,8 |
| 122-B | Stagschnalle aus Messing buckle made from solid brass | * 122-B-3/4" | 18,5 | 31,0 | | 1,5 |
|  | | * 122-B-5/8" | 15,6 | 25,0 | | 1,0 |
| 123-B | Stagschnalle aus Messing buckle made from solid brass | * 123-B-20 | 18,8 | 33,1 | | 2,5 |
|  | | * 123-B-16 | 16,4 | 29,8 | | 1,0 |
| | | * 123-B-13 | 12,8 | 26,1 | | 0,8 |
| 124-B | Stagschnalle aus Messing buckle made from solid brass | * 124-B-5/8" | 15,6 | 26,2 | | 1,0 |
|  | | | | | | |
| 210-B | Conway-Schnalle aus Messing conway buckle made from solid brass | * 210-B-1" | 28,3 | 40,3 | 15,6 | 3,1 |
|  | | * 210-B-3/4" | 20,1 | 31,5 | 13,7 | 1,9 |
| | | * 210-B-5/8" | 16,3 | 26,3 | 11,6 | 1,0 |
| | | * 210-B-1/2" | 13,9 | 24,2 | 9,7 | 0,8 |
| 369-B | Halfterring mit zwei Ösen aus Messing halter ring with two eyelets made from solid brass | * 369-B-1" | 27,3 | 31,6 | | 4,8 |
|  | | * 369-B-3/4" | 20,0 | 22,0 | | 2,9 |
| | | * 369-B-1/2" | 13,6 | 21,8 | | 1,4 |

Schnallen aus Messing
buckles made from solid brass

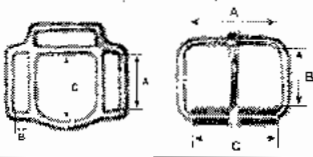

D = Gewicht (kg) bei 100 Stück
weight (kg) per 100 pieces

Alle Maße in mm
all measurements in mm

| Art.-Nr. / item no. 370-B | Art.-Nr. / item no. | A | B | C | D |
|------------------------------|---------------------|---|---|---|---|
|------------------------------|---------------------|---|---|---|---|



Halfterring mit drei Ösen
aus Messing

halter ring with three eyelets made
from solid brass

| | | | | |
|------------|------|-----|------|-----|
| * 370-B-1" | 27,0 | 6,0 | 31,6 | 5,4 |
|------------|------|-----|------|-----|

| Art.-Nr. / item no. 5-B | Art.-Nr. / item no. | A | B | C | D |
|----------------------------|---------------------|---|---|---|---|
|----------------------------|---------------------|---|---|---|---|



Schnalle aus Messing

buckle made from solid brass

| | | | | |
|------------|------|------|--|-----|
| * 5-B-1" | 26,4 | 33,0 | | 2,7 |
| * 5-B-3/4" | 20,9 | 25,3 | | 1,8 |
| * 5-B-5/8" | 16,8 | 20,7 | | 1,2 |
| * 5-B-1/2" | 14,0 | 17,5 | | 1,1 |

| Art.-Nr. / item no. 5705-B | Art.-Nr. / item no. | A | B | C | D |
|-------------------------------|---------------------|---|---|---|---|
|-------------------------------|---------------------|---|---|---|---|



Stegschnalle aus Messing

step buckle made from solid brass

| | | | | |
|-----------------|------|------|--|-----|
| * 5705-B-1 1/4" | 35,4 | 49,9 | | 5,2 |
| * 5705-B-1 1/8" | 31,1 | 48,4 | | 5,4 |
| * 5705-B-1" | 27,2 | 42,5 | | 3,7 |
| * 5705-B-3/4" | 21,0 | 38,0 | | 2,9 |
| * 5705-B-5/8" | 18,4 | 34,8 | | 2,1 |

| Art.-Nr. / item no. 5706-B | Art.-Nr. / item no. | A | B | C | D |
|-------------------------------|---------------------|---|---|---|---|
|-------------------------------|---------------------|---|---|---|---|



Doppelstegschnalle
aus Messing

double step buckle made from
solid brass

| | | | | |
|-------------|------|------|--|-----|
| * 5706-B-1" | 29,0 | 46,2 | | 4,9 |
|-------------|------|------|--|-----|

| Art.-Nr. / item no. 66415-M | Art.-Nr. / item no. | A | B | C | D |
|--------------------------------|---------------------|---|---|---|---|
|--------------------------------|---------------------|---|---|---|---|



Rollschnalle aus Messing

roller buckle made from solid brass

| | | | | |
|--------------|------|------|------|-----|
| * 66415-B 32 | 33,3 | 36,5 | 31,1 | 5,8 |
| * 66415-B 28 | 26,6 | 31,2 | 24,0 | 4,1 |
| * 66415-B 25 | 26,0 | 27,8 | 21,0 | 2,9 |
| * 66415-B 23 | 23,8 | 25,0 | 18,6 | 2,6 |
| * 66415-B 18 | 19,9 | 21,7 | 18,5 | 2,1 |
| * 66415-B 16 | 17,7 | 19,3 | 15,7 | 1,8 |
| * 66415-B 14 | 14,0 | 15,8 | 11,6 | 1,0 |

Schnallen, Schieber, Schlaufen aus Edelstahl
 buckles, slides, loops made from stainless steel

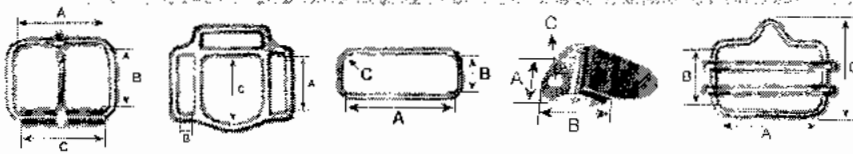

D = Gewicht (kg) bei 100 Stück
 weight (kg) per 100 pieces

Alle Maße in mm
 all measurements in mm

| Art.-Nr. / item no. | Art.-Nr. / item no. | A | B | C | D |
|---------------------|---------------------|---|---|---|---|
|---------------------|---------------------|---|---|---|---|



Steigbügelschnalle aus Edelstahl
 AISI 316

4-in-1 up buckle made from stainless steel
 AISI 316

1180-I-29

28,0 29,4 3,3

~~1180-I-25~~

~~25,5 30,9 3,0~~

| Art.-Nr. / item no. | Art.-Nr. / item no. | A | B | C | D |
|---------------------|---------------------|---|---|---|---|
|---------------------|---------------------|---|---|---|---|



Sattelgurtschnalle aus Edelstahl
 AISI 316

saddle girth buckle made from
 stainless steel AISI 316

1280-I-1LW

26,7 42,6 25,0 3,8

| Art.-Nr. / item no. | Art.-Nr. / item no. | A | B | C | D |
|---------------------|---------------------|---|---|---|---|
|---------------------|---------------------|---|---|---|---|



Klemmschnalle aus Edelstahl
 AISI 316

clamp buckle made from stainless steel
 AISI 316

487-I

18,4 24,2 4,4 0,7

| Art.-Nr. / item no. | Art.-Nr. / item no. | A | B | C | D |
|---------------------|---------------------|---|---|---|---|
|---------------------|---------------------|---|---|---|---|



Breitbandverbinder aus Edelstahl
 AISI 316

buckle made from stainless steel AISI 316

4960-I-40

39,1 24,0 40,1 2,0

~~4960-I-20~~

~~26,7 15,6 27,7 0,6~~

| Art.-Nr. / item no. | Art.-Nr. / item no. | A | B | C | D |
|---------------------|---------------------|---|---|---|---|
|---------------------|---------------------|---|---|---|---|

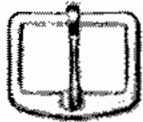

Zaumschnalle aus Edelstahl
 AISI 316

bridle buckle made from stainless steel
 AISI 316

66510-I-25

26,0 16,4 0,7

~~66510-I-23~~

~~23,3 15,5 0,6~~

66510-I-20

18,6 12,4 0,3

~~66510-I-18~~

~~17,7 12,8 0,5~~

66510-I-16

16,3 12,3 0,4

~~66510-I-13~~

~~13,2 12,6 0,3~~

66510-I-10

10,1 9,4 0,2

| Art.-Nr. / item no. | Art.-Nr. / item no. | A | B | C | D |
|---------------------|---------------------|---|---|---|---|
|---------------------|---------------------|---|---|---|---|

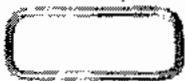

Schleife aus Edelstahl AISI 316

loop made from stainless steel AISI 316

1670-I-30

33,0 10 2,8 0,4

Schnallen, Schieber, Schlaufen aus Plastik
buckles, slides, loops made from plastic

D = Gewicht (kg) bei 100 Stück
 weight (kgs) per 100 pieces

Alle Maße in mm
 all measurements in mm

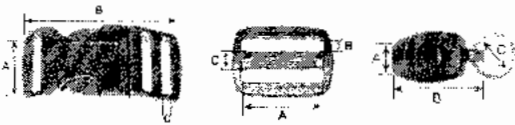

| Art.-Nr. / item no. 212-P | Art.-Nr. / item-no. | A | B | C | D | |
|------------------------------|---------------------------------------|----------|------|------|-----|-----|
| | Steckschnalle aus Plastik | 212-P-50 | 51,3 | 80,8 | 5,2 | 3,5 |
| | side release buckle made from plastic | 212-P-40 | 38,8 | 71,0 | 5,3 | 1,8 |
| | | 212-P-30 | 30,8 | 64,3 | 3,7 | 1,3 |
| | | 212-P-25 | 25,8 | 58,5 | 5,7 | 1,0 |
| | | 212-P-20 | 19,9 | 55,2 | 3,9 | 0,6 |
| | | 212-P-15 | 15,9 | 42,6 | 3,0 | 0,3 |

| Art.-Nr. / item no. 213-P | Art.-Nr. / item-no. | A | B | C | D | |
|------------------------------|--------------------------------|----------|------|------|-----|-----|
| | Steckschnalle aus Plastik | 213-P-25 | 27,4 | 49,3 | 3,3 | 0,4 |
| | stick buckle made from plastic | 213-P-20 | 19,3 | 42,0 | 2,3 | 0,2 |

| Art.-Nr. / item no. 216-P | Art.-Nr. / item-no. | A | B | C | D | |
|------------------------------|------------------------------|----------|------|------|-----|-----|
| | Klemmschloß aus Plastik | 216-P-50 | 53,3 | 84,0 | 4,1 | 3,8 |
| | cam buckle made from plastic | 216-P-40 | 38,3 | 55,8 | 3,8 | 3,2 |
| | | 216-P-25 | 25,3 | 35,7 | 3,1 | 1,0 |
| | | 216-P-20 | 18,8 | 29,8 | 2,3 | 0,4 |
| | | 216-P-15 | 16,3 | 27,4 | 2,8 | 0,3 |

| Art.-Nr. / item no. 218-P | Art.-Nr. / item-no. | A | B | C | D | |
|------------------------------|--|----------|------|------|-----|-----|
| | Steckschnalle gebogen aus Plastik | 218-P-25 | 25,7 | 67,8 | 3,6 | 0,8 |
| | side release buckle banded made from plastic | 218-P-20 | 18,3 | 53,1 | 3,8 | 0,6 |
| | | 218-P-16 | 16,1 | 45,6 | 2,8 | 0,3 |
| | | 218-P-10 | 11,2 | 34,5 | 3,4 | 0,2 |

| Art.-Nr. / item no. 220-P | Art.-Nr. / item-no. | A | B | C | D | |
|------------------------------|--|-------|------|------|------|-----|
| | Steckschnalle aus Plastik mit Schlüsselring | 220-P | 12,9 | 43,7 | 17,5 | 0,6 |
| | stick buckle made from plastic with key ring | | | | | |

| Art.-Nr. / item no. 221-P | Art.-Nr. / item-no. | A | B | C | D | |
|------------------------------|--------------------------------|-------|------|------|-----|-----|
| | Steckschnalle aus Plastik | 221-P | 20,0 | 29,8 | 2,5 | 0,2 |
| | stick buckle made from plastic | | | | | |

| Art.-Nr. / item no. 214-P | Art.-Nr. / item-no. | A | B | C | D |
|------------------------------|-------------------------------|----------|------|------|-----|
| | Leitersteg aus Plastik | 214-P-25 | 25,2 | 38,8 | 0,3 |
| | ladder lock made from plastic | | | | |

Schnallen, Schieber, Schlaufen aus Plastik
 buckles, slides, loops made from plastic

D = Gewicht (kg) bei 100 Stück
 weight (kg) per 100 pieces

Alle Maße in mm
 all measurements in mm

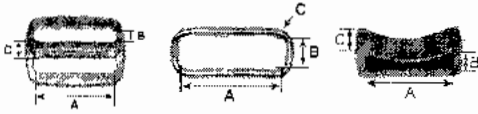

| Art.-Nr. / item no. | | Art.-Nr. / item no. | A | B | C | D |
|---------------------|-------------------------------------|---------------------|------|-----|------|-----|
| 215-P | | | | | | |
| | Schieber aus Plastik | 215-P-50 | 50,6 | 8,4 | 8,5 | 0,8 |
| | slide made from plastic | 215-P-40 | 38,4 | 7,1 | 7,0 | 0,5 |
| | | 215-P-30 | 32,2 | 5,8 | 5,9 | 0,4 |
| | | 215-P-25 | 26,5 | 4,4 | 5,4 | 0,3 |
| | | 215-P-20 | 21,0 | 4,5 | 4,9 | 0,3 |
| | | 215-P-16 | 16,0 | 5,8 | 4,7 | 0,2 |
| | | 215-P-12 | 13,0 | 4,7 | 4,0 | 0,2 |
| 217-P | | | | | | |
| | Schieber aus Plastik | 217-P-25 | 25,7 | 8,9 | 6,0 | 0,3 |
| | slide made from plastic | 217-P-20 | 20,9 | 7,6 | 5,2 | 0,2 |
| | | 217-P-16 | 16,4 | 7,0 | 4,1 | 0,1 |
| | | 217-P-10 | 11,2 | 5,3 | 1,9 | 0,1 |
| 257-P | | | | | | |
| | Schleufe aus Plastik | 257-P-50 | 50,9 | 7,2 | 4,0 | 0,4 |
| | loop made from plastic | 257-P-30 | 31,9 | 7,0 | 3,8 | 0,2 |
| | | 257-P-25 | 25,9 | 6,8 | 2,9 | 0,2 |
| | | 257-P-20 | 18,9 | 6,1 | 3,4 | 0,1 |
| 2570-P | | | | | | |
| | Schleufe gebogen aus Plastik | 2570-P-25 | 25,2 | 6,0 | 11,0 | 0,2 |
| | loop made from plastic | 2570-P-20 | 18,9 | 4,9 | 11,5 | 0,2 |
| | | 2570-P-16 | 16,5 | 4,0 | 10,6 | 0,1 |

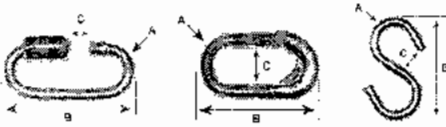

Kettenschraub- u. Notglieder, S-Haken aus Stahl

quick links and connection links; s-hooks made from steel

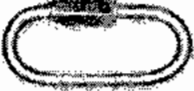
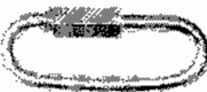

D = Gewicht (kg) bei 100 Stück
weight (kgs) per 100 pieces

Alle Maße in mm
all measurements in mm



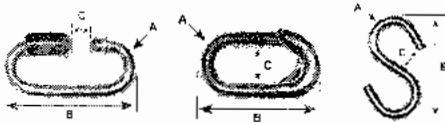

| Art.-Nr. / item no. | Art.-Nr. / item no. | A | B | C | D |
|---|---------------------|------|------|------|------|
| 200  Kettenschraubglied aus Stahl, verzinkt quick link made from steel, zinc plated | 216-16,0 | 15,8 | 147 | 18,1 | 55,0 |
| | 214-14,0 | 13,8 | 123 | 16,3 | 34,9 |
| | 212-12,0 | 12,0 | 106 | 14,0 | 21,3 |
| | 210-10,0 | 10,0 | 90 | 12,7 | 13,1 |
| | 208-8,0 | 8,0 | 75 | 12,0 | 7,2 |
| | 207-7,0 | 6,7 | 64 | 8,9 | 4,6 |
| | 206-6,0 | 6,0 | 58 | 8,1 | 3,2 |
| | 205-5,0 | 6,0 | 50 | 8,2 | 1,9 |
| | 204-4,0 | 4,0 | 41 | 6,0 | 1,0 |
| | 203-3,5 | 3,5 | 38 | 8,0 | 0,7 |
| 200-A  Kettenschraubglied mit großer Öffnung aus Stahl, verzinkt quick link with wide opening made from steel, zinc plated | 208-A-8 | 7,9 | 88,0 | 18,3 | 8,3 |
| | 206-A-6 | 5,8 | 70,8 | 15,9 | 3,7 |
| | 205-A-5 | 4,9 | 63,8 | 12,3 | 2,9 |
| | 204-A-4 | 4,0 | 53,0 | 5,6 | 1,5 |
| 89  Kettennotglied aus Stahl, verzinkt connection link made from steel, zinc plated | 89-12,0 | 11,6 | 60 | 21 | 15,2 |
| | 89-10,0 | 9,7 | 61 | 16 | 7,8 |
| | 89-9,0 | 9,0 | 58 | 16 | 6,5 |
| | 89-8,0 | 7,6 | 64 | 15 | 4,4 |
| | 89-7,0 | 7,0 | 47 | 13 | 3,4 |
| | 89-6,5 | 6,4 | 45 | 13 | 3,1 |
| | 89-6,0 | 5,8 | 42 | 13 | 1,9 |
| | 89-5,5 | 5,5 | 38 | 11 | 1,4 |
| | 89-5,0 | 4,9 | 35 | 9 | 1,2 |
| | 89-4,5 | 4,5 | 31 | 8 | 1,0 |
| 89-4,0 | 4,0 | 28 | 7 | 0,6 | |
| 89-3,5 | 3,4 | 25 | 8 | 0,5 | |
| 89-3,0 | 3,0 | 23 | 6 | 0,4 | |
| 90  S-Haken aus Stahl, verzinkt s-hook made from steel, zinc plated | 90-10,0 | 9,8 | 98 | 16 | 11,5 |
| | 90-8,0 | 7,8 | 73 | 15 | 5,8 |
| | 90-7,0 | 7,1 | 68 | 7 | 4,6 |
| | 90-6,0 | 5,8 | 53 | 8 | 2,5 |
| | 90-5,0 | 4,8 | 46 | 7 | 1,2 |
| | 90-4,5 | 4,6 | 44 | 5 | 1,3 |
| | 90-4,0 | 4,2 | 35 | 7 | 1,1 |
| | 90-3,5 | 3,5 | 34 | 4 | 0,6 |
| | 90-3,0 | 3,0 | 25 | 3 | 0,3 |
| 90-2,5 | 2,5 | 25 | 3 | 0,2 | |

Kettenschraub- u. Notglieder, S-Haken aus Edelstahl
 quick links and connection links, s-hooks made from stainless steel



D = Gewicht (kg) bei 100 Stück
 weight (kg) per 100 pieces

Alle Maße in mm
 all measurements in mm

| Art.-Nr. / item no. | Art.-Nr. / item no. | A | B | C | D |
|---|---------------------|------|-------|------|------|
| 200-I  Kettenschraubglied aus Edelstahl AISI 316 quick link made from stainless steel AISI 316 | 212-I-12,0 | 11,7 | 104,6 | 13,3 | 21,1 |
| | 210-I-10,0 | 9,9 | 88,6 | 11,6 | 12,9 |
| | 208-I-8,0 | 7,9 | 75,0 | 9,9 | 7,9 |
| | 206-I-6,0 | 5,8 | 56,4 | 7,0 | 3,0 |
| | 205-I-5,0 | 5,0 | 49,0 | 5,4 | 2,0 |
| | 204-I-4,0 | 4,0 | 39,8 | 5,4 | 0,9 |
| 89-I  Kettennotglied aus Edelstahl AISI 316 connection link made from stainless steel AISI 316 | 89-I-6,0 | 5,8 | 35,4 | 13,3 | 2,3 |
| | 88-I-5,0 | 5,3 | 45,6 | 12,6 | 2,1 |
| | 89-I-4,0 | 3,9 | 27,0 | 11,0 | 0,9 |
| | | | | | |
| 90-I  S-Haken aus Edelstahl AISI 316 s-hook made from stainless steel AISI 316 | 90-I-6,0 | 6,0 | 57,8 | 11,7 | 2,6 |
| | 90-I-5,0 | 4,9 | 44,7 | 8,9 | 1,4 |
| | 90-I-4,0 | 4,0 | 40,0 | 4,3 | 0,9 |
| | 90-I-3,0 | 3,0 | 26,8 | 6,5 | 0,4 |
| 900-I  Fleischerhaken aus Edelstahl AISI 304 meat-hook made from stainless steel AISI 304 | 900-I-140 | 5,3 | 141,2 | 42,3 | 4,6 |
| | 900-I-120 | 4,8 | 122,6 | 36,8 | 3,9 |
| | 900-I-100 | 4,5 | 100,8 | 30,6 | 2,2 |
| | 900-I-80 | 3,8 | 81,4 | 26,1 | 1,5 |

Schäkel aus Stahl
shackles made from steel

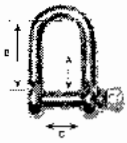



D = Gewicht (kg) bei 100 Stück
weight (kgs) per 100 pieces

Alle Maße in mm
all measurements in mm

| Art.-Nr. / item no. 600 | | Art.-Nr. / item no. | A | B | C | D |
|---|---|---------------------|------|-------|------|-------|
|  | Schäkel gerade Form, aus Stahl, verzinkt shackles straight form, made from steel, zinc plated | 500-25-1 | 24,0 | 100,0 | 48,1 | 155,5 |
| | | 500-22-7/8 | 21,1 | 84,8 | 43,9 | 105,4 |
| | | 500-19-3/4 | 19,3 | 69,8 | 37,2 | 74,8 |
| | | 500-16-5/8 | 15,2 | 60,2 | 30,3 | 69,8 |
| | | 500-14-9/16 | 13,0 | 47,0 | 27,5 | 25,1 |
| | | 500-12-1/2 | 10,6 | 39,5 | 25,1 | 16,9 |
| | | 500-11-7/16 | 9,3 | 43,5 | 21,7 | 11,3 |
| | | 500-10-3/8 | 8,1 | 36,1 | 19,8 | 8,8 |
| | | 500-8-5/16 | 7,2 | 30,9 | 17,3 | 4,7 |
| | | 500-8-1/4 | 5,3 | 24,3 | 13,4 | 2,3 |
| 500-5-3/16 | 4,6 | 18,0 | 10,7 | 1,3 | | |

| Art.-Nr. / item no. 600 | | Art.-Nr. / item no. | A | B | C | D |
|---|---|---------------------|------|-------|------|-------|
|  | Schäkel geschweifte Form, aus Stahl, verzinkt shackles bow form, made from steel, zinc plated | 800-25-1 | 24,5 | 100,0 | 48,1 | 180,5 |
| | | 800-22-7/8 | 20,8 | 87,7 | 45,8 | 110,6 |
| | | 800-19-3/4 | 19,0 | 69,5 | 37,4 | 77,7 |
| | | 800-16-5/8 | 15,7 | 64,0 | 31,5 | 49,9 |
| | | 800-14-9/16 | 13,4 | 59,3 | 30,3 | 31,2 |
| | | 800-12-1/2 | 10,5 | 46,4 | 28,8 | 16,9 |
| | | 800-11-7/16 | 10,6 | 41,6 | 23,5 | 12,8 |
| | | 800-10-3/8 | 8,8 | 38,7 | 17,5 | 9,2 |
| | | 800-8-5/16 | 7,3 | 31,9 | 18,2 | 6,4 |
| | | 800-8-1/4 | 5,5 | 25,7 | 14,4 | 2,2 |
| 800-5-3/16 | 4,6 | 20,7 | 16,7 | 1,5 | | |

| Art.-Nr. / item no. 700 | | Art.-Nr. / item no. | A | B | C | D |
|---|---|---------------------|------|-------|------|-------|
|  | Hochfeste Schäkel gerade Form, aus Stahl, verzinkt high strength shackles straight form, made from steel, zinc plated | 700-13,5 | 38,1 | 112,8 | 61,5 | 548,5 |
| | | 700-12,0 | 35,0 | 100,4 | 51,5 | 495,0 |
| | | 700-9,5 | 32,4 | 92,0 | 48,0 | 312,0 |
| | | 700-8,5 | 28,8 | 78,8 | 46,4 | 214,6 |
| | | 700-6,5 | 25,2 | 72,2 | 35,4 | 143,7 |
| | | 700-4,75 | 22,2 | 62,4 | 34,0 | 109,0 |
| | | 700-3,25 | 18,8 | 50,8 | 29,1 | 57,7 |
| | | 700-2,0 | 15,7 | 41,0 | 21,1 | 28,2 |
| | | 700-1,5 | 12,7 | 38,1 | 18,4 | 18,6 |
| | | 700-1,0 | 11,4 | 31,4 | 17,0 | 13,7 |
| 700-0,75 | 9,4 | 24,0 | 11,2 | 7,4 | | |
| 700-0,5 | 7,6 | 21,8 | 12,0 | 4,4 | | |

| Art.-Nr. / item no. 701 | | Art.-Nr. / item no. | A | B | C | D |
|---|---|---------------------|------|-------|------|-------|
|  | Hochfeste Schäkel geschweifte Form, aus Stahl, verzinkt high strength shackles bow form, made from steel, zinc plated | 701-13,5 | 38,1 | 113,4 | 57,2 | 540,0 |
| | | 701-12,0 | 35,1 | 117,2 | 50,5 | 472,0 |
| | | 701-9,5 | 32,2 | 105,1 | 46,4 | 334,5 |
| | | 701-8,5 | 28,0 | 96,8 | 46,2 | 230,5 |
| | | 701-6,5 | 25,0 | 83,4 | 38,9 | 168,5 |
| | | 701-4,75 | 22,1 | 72,0 | 33,9 | 105,5 |
| | | 701-3,25 | 18,6 | 60,0 | 28,0 | 64,8 |
| | | 701-2,0 | 15,7 | 47,2 | 21,0 | 31,5 |
| | | 701-1,5 | 12,7 | 43,8 | 18,7 | 18,5 |
| | | 701-1,0 | 11,6 | 35,9 | 20,0 | 12,8 |
| 701-0,75 | 9,4 | 29,8 | 13,4 | 8,5 | | |
| 701-0,5 | 8,0 | 30,1 | 12,3 | 4,9 | | |

Schäkel aus Stahl, verzinkt
shackles made from steel, zinc plated

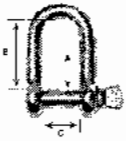

D = Gewicht (kg) bei 100 Stück
weight (kgs) per 100 pieces

Alle Maße in mm
all measurements in mm

| Art.-Nr. / item no. | Art.-Nr. / item no. | A | B | C | D |
|---|---------------------|------|-------|------|-------|
| 82101-A | | | | | |
| Schäkel gerade Form, ähnlich DIN 82101-A, aus Stahl, verzinkt shackles straight form acc. DIN 82101 A, made from steel, zinc plated | 82101-A-8,0 | 45,0 | 138,5 | 60,0 | 780,0 |
| | 82101-A-6,0 | 38,4 | 118,2 | 54,0 | 534,5 |
| | 82101-A-5,0 | 35,2 | 108,4 | 48,4 | 384,5 |
| | 82101-A-4,0 | 29,4 | 91,2 | 41,6 | 257,0 |
| | 82101-A-3,0 | 27,3 | 86,0 | 38,8 | 185,5 |
| | 82101-A-2,5 | 24,5 | 71,8 | 33,7 | 130,8 |
| | 82101-A-2,0 | 22,2 | 68,5 | 29,7 | 98,7 |
| | 82101-A-1,6 | 19,5 | 59,7 | 26,5 | 59,0 |
| | 82101-A-1,0 | 15,9 | 48,3 | 22,0 | 30,4 |
| | 82101-A-0,8 | 11,3 | 38,5 | 16,8 | 17,3 |
| | 82101-A-0,4 | 9,6 | 28,2 | 14,5 | 8,8 |
| | 82101-A-0,25 | 7,9 | 24,3 | 11,5 | 5,3 |
| | 82101-A-0,16 | 5,8 | 18,0 | 8,7 | 2,0 |
| 82101-A-0,1 | 5,0 | 15,9 | 7,3 | 1,4 | |

Schäkel aus Edelstahl
shackles made from stainless steel



D = Gewicht (kg) bei 100 Stück
weight (kgs) per 100 pieces

Alle Maße in mm
all measurements in mm





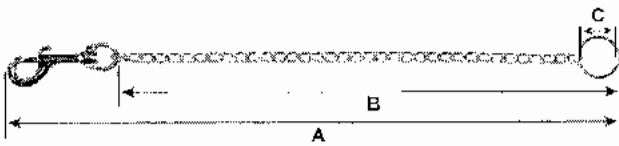

| Art.-Nr. / item no. | Art.-Nr. / item no. | A | B | C | D |
|--|---------------------|------|------|------|------|
| 500-I | | | | | |
| Schäkel gerade Form, aus Edelstahl AISI 316 shackles straight form, made from stainless steel AISI 316 | 500-I-16 | 15,8 | 64,2 | 33,7 | 48,7 |
| | 500-I-12 | 11,8 | 51,7 | 26,5 | 27,0 |
| | 500-I-10 | 9,9 | 40,0 | 22,5 | 11,4 |
| | 500-I-8 | 7,7 | 31,9 | 18,3 | 6,1 |
| | 500-I-6 | 6,0 | 25,0 | 12,4 | 2,4 |
| | 500-I-5 | 5,0 | 21,4 | 10,5 | 1,7 |
| | 500-I-4 | 3,8 | 16,8 | 8,7 | 0,7 |
| 600-I | | | | | |
| Schäkel geschweifte Form, aus Edelstahl AISI 316 shackles hook form, made from stainless steel AISI 316 | 600-I-12 | 11,6 | 48,0 | 25,3 | 20,0 |
| | 600-I-10 | 9,7 | 42,6 | 21,2 | 18,1 |
| | 600-I-8 | 7,7 | 31,0 | 16,3 | 6,4 |
| | 600-I-6 | 5,8 | 25,0 | 13,4 | 2,7 |
| | 600-I-5 | 4,8 | 21,1 | 9,8 | 1,7 |
| | 600-I-4 | 3,6 | 16,6 | 8,7 | 1,0 |
| 66526-I | | | | | |
| Patentschäkel aus Edelstahl AISI 316 swivel hook shackles made from stainless steel AISI 316 | 66526-128 | 8,7 | 133 | 21,3 | 37,0 |
| | 66526-90 | 7,8 | 82 | 13,2 | 16,5 |

Ketten und Schlüsselketten aus Stahl chains and key-chains made from steel

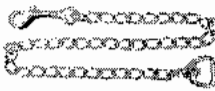
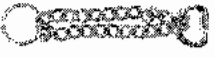

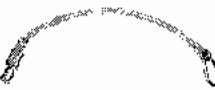
D = Gewicht (kg) bei 100 Stück
weight (kg) per 100 pieces

Alle Maße in mm
all measurements in mm

| Art.-Nr. / item no. | Art.-Nr. / item-no. | A | B | C | D |
|---|---|----------------------|------------------|------------------|-----------------|
| 40 | * 40-4,0x30" | 785,0 | 695,0 | 15,6 | 30,5 |
|  | Kette mit Karabinerhaken und Wirbel, vernickelt chain with snap hook and swivel, nickel plated | 777,0 | 687,0 | 15,5 | 22,4 |
| 42 | 42-3,5x200 | 140,0 | 80,0 | 23,0 | 7,4 |
|  | Durchzugkette aus Stahl, mit zwei D-Ringen und Ring vern. chain made from steel, with two D-rings and ring nickel plated | 42-2,5x200 | 137,0 | 80,5 | 20,5 |
| | 42-2,0x120 | 95,0 | 54,0 | 17,2 | 1,9 |
| 7115 | 7115-5025 | 530,0 | 455,0 | 21,0 | 6,7 |
|  | Schlüsselkette mit Karabinerhaken u. Schlüsselring, vernickelt key chain with snap hook and key ring, nickel plated | 7115-5579 | 502,0 | 455,0 | 24,9 |
| 7116 | 7116-30 cp | 445,0 | 365,0 | 25,0 | 11,5 |
|  | Schlüsselkette mit Karabinerhaken u. Schlüsselring, verchromt key chain with snap hook and key ring, chrome plated | 7116-18 cp | 445,0 | 370,0 | 21,0 |
| | 7116-16 cp | 438,0 | 335,0 | 21,0 | 4,0 |
| 8490 | 8490-140 | 1425 | 1273 | | 8,1 |
|  | Anbindekette m. Plastiküberzug, Panikhaken u. Karabinerhaken, safety chain with plastic tube, panic snap and snap hook, zinc plated | 8490-90 | 1025 | 870,0 | 8,2 |
| | 8490-70 | 835,0 | 882,0 | | 5,4 |
| | 8490-55 | 565,0 | 410,0 | | 4,0 |
| 8561 | 8561-3,0x800 | 809,0 | 734,0 | 22,5 | 18,7 |
|  | Ansatzkette mit Karabinerhaken und Ring, verchromt chain lead with snap hook and ring, chrome plated | 8561-3,0x600 | 820,0 | 645,0 | 23,0 |
| | 8561-2,0x1000 | 1015 | 835,0 | 24,6 | 9,9 |
| | 8561-2,0x400 | 405,0 | 330,0 | 24,8 | 5,2 |
| | 8561-1,6x1000 | 1025 | 863,0 | 24,8 | 6,8 |
| 8562 | 8562-3,0x600 | 635,0 | 550,0 | 25,4 | 15,3 |
|  | Ansatzkette mit Karabinerhaken und Ring, verchromt chain lead with snap hook and ring, chrome plated | | | | |
| 8590 | 8590-3/4" | 117,0 | 100,0 | 19,2 | 4,6 |
|  | Doppelkinnkette, verchromt double curb chain, chrome plated | | | | |

Ketten und Schlüsselketten aus Edelstahl
chains and key-chains made from stainless steel

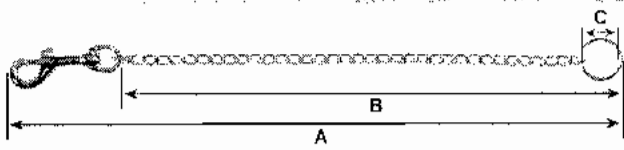

D = Gewicht (kg) bei 100 Stück
weight (kgs) for 100 pieces

Alle Maße in mm
all measurements in mm

Art.-Nr. / item no.
66527-1

Art.-Nr. / item no.

A

B

C

D

**Aufhalkette mit
 Karabinerhaken 80x8 aus
 Edelstahl AISI 316**

66527-1-114 1200 1120 45,3 97,0

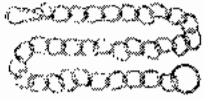

*chain with snap hook 80x8 made
 from stainless steel AISI 316*



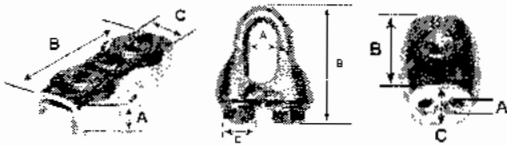

Simplex-, Duplex-, Eiform- und Drahtseilklemmen, Seilschloß, Spanschlösser, Wantenspanner, Kauschen sowie Achten mit Klappe aus Stahl, verzinkt, Pressklemmen aus Aluminium

simplex- and duplex clamps, egg shaped wire rope clips, wire rope clips, rope socket, turnbuckles, rigging screws, thimbles, rope shortenings with blacking made from steel, zinc plated, alloy ferrules



D = Gewicht (kg) bei 100 Stück
weight (kgs) per 100 pieces

Alle Maße in mm
all measurements in mm

| Art.-Nr. / item no. | Art.-Nr. / item no. | A | B | C | D | |
|--|--|-------------|------|-------|------|-------|
| 103  | Simplexklemme aus Stahl, verzinkt | 103-8 | 10,6 | 36,0 | 23,0 | 4,6 |
| | simplex clamp made from steel, zinc plated | 103-6 | 8,6 | 28,2 | 16,6 | 2,2 |
| | | 103-5 | 8,6 | 24,0 | 13,7 | 1,2 |
| | | 103-4 | 6,8 | 18,7 | 12,7 | 1,0 |
| | | 103-3 | 6,0 | 17,9 | 9,7 | 0,6 |
| | | 103-2 | 4,9 | 14,7 | 8,6 | 0,6 |
| 104  | Duplexklemme aus Stahl, verzinkt | 104-8 | 10,7 | 76,0 | 22,7 | 9,4 |
| | duplex clamp made from steel, zinc plated | 104-6 | 8,6 | 60,0 | 15,7 | 4,5 |
| | | 104-5 | 7,8 | 50,0 | 14,1 | 2,9 |
| | | 104-4 | 7,3 | 40,0 | 13,0 | 2,1 |
| | | 104-3 | 5,8 | 35,0 | 8,6 | 1,1 |
| | | 104-2 | 4,9 | 34,0 | 7,0 | 0,9 |
| 1142  | Drahtseilklemme ähnlich DIN 1142 aus Stahl, verzinkt | 1142-30,0 | 36,1 | 128,8 | 31,6 | 143,2 |
| | wire rope clip acc. DIN 1142 made from steel, zinc plated | 1142-26,0 | 28,3 | 111,3 | 31,6 | 110,0 |
| | | 1142-22,0 | 26,0 | 87,0 | 23,8 | 66,5 |
| | | 1142-18,0 | 24,0 | 84,0 | 21,8 | 48,4 |
| | | 1142-16,0 | 19,0 | 76,8 | 21,0 | 42,0 |
| | | 1142-13,0 | 14,5 | 64,0 | 16,8 | 25,6 |
| | | 1142-10,0 | 11,3 | 47,6 | 12,8 | 8,0 |
| | | 1142-8,0 | 11,7 | 48,3 | 12,8 | 7,5 |
| | | 1142-6,5 | 7,9 | 28,0 | 9,8 | 3,7 |
| 1142-5,0 | 7,6 | 27,0 | 7,9 | 1,8 | | |
| 400  | Drahtseilklemme ähnlich DIN 741 aus Stahl, verzinkt | 400-25-1 | 28,8 | 93,8 | 21,7 | 43,2 |
| | wire rope clip acc. DIN 741 made from steel, zinc plated | 400-22-7/8 | 24,8 | 85,4 | 21,7 | 38,5 |
| | | 400-18-3/4 | 20,1 | 67,0 | 18,8 | 22,6 |
| | | 400-16-5/8 | 18,7 | 63,5 | 18,6 | 18,3 |
| | | 400-14-9/16 | 15,3 | 52,6 | 16,8 | 12,1 |
| | | 400-12-1/2 | 13,7 | 52,2 | 18,8 | 10,8 |
| | | 400-11-7/16 | 12,0 | 42,0 | 13,8 | 6,0 |
| | | 400-10-3/8 | 11,5 | 43,0 | 12,7 | 6,0 |
| | | 400-8-5/16 | 10,4 | 35,0 | 9,8 | 3,1 |
| | | 400-6-1/4 | 8,8 | 26,8 | 7,9 | 1,5 |
| | | 400-5-3/16 | 6,4 | 23,5 | 7,9 | 1,4 |
| 400-3-1/8 | 5,4 | 18,6 | 6,8 | 0,9 | | |
| 450  | Eiformklemme aus Zinkdruckguss, verzinkt | 450-6 | 5,0 | 34,5 | 12,0 | 4,6 |
| | egg shaped wire rope clip made from zinc die cast, zinc plated | 450-5 | 4,7 | 33,5 | 12,5 | 4,3 |
| | | 450-4 | 4,3 | 33,8 | 11,8 | 3,8 |
| | | 450-3 | 3,0 | 27,5 | 8,5 | 1,8 |
| | | 450-2 | 1,4 | 27,8 | 8,5 | 1,6 |



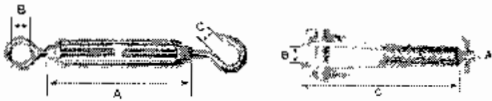

Simplex-, Duplex-, Eiform- und Drahtseilklemmen, Seilschloß, Spannschlösser, Wartenspanner, Kauschen sowie Achten mit Klappe aus Stahl, verzinkt, Pressklemmen aus Aluminium

simplex- and duplex clamps, egg shaped wire rope clips, wire rope clips, rope socket, turnbuckles, rigging screws, thimbles, rope shortenings with blocking made from steel, zinc plated, al alloy ferrules

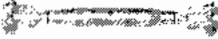

D = Gewicht (kg) bei 100 Stück
weight (kgs) per 100 pieces

Alle Maße in mm
all measurements in mm

| Art.-Nr. / item no. | Art.-Nr. / item no. | A | B | C | D |
|---|---------------------|-------|------|-------|-------|
| 1020 | | | | | |
|  <p>Spannschloß aus Zinkdruckguss, verzinkt Ausführung: H+Ö / Ö+Ö / H+H turnbuckle made from zinc die cast, zinc plated model: h+o / o+o / h+h</p> | 1020-M10x80 | 79,3 | 12,4 | 12,8 | 15,5 |
| | 1020-M8x110 | 109,5 | 10,8 | 11,7 | 12,4 |
| | 1020-M8x70 | 88,2 | 10,5 | 11,4 | 8,2 |
| | 1020-M8x100 | 88,2 | 10,8 | 10,8 | 8,8 |
| | 1020-M6x60 | 60,1 | 11,3 | 10,5 | 4,8 |
| | 1020-M5x70 | 70,2 | 9,3 | 9,8 | 3,6 |
| | 1020-M5x50 | 48,6 | 7,8 | 8,0 | 3,2 |
| 1480 | | | | | |
|  <p>Spannschloß ähnlich DIN 1480 aus Stahl, verzinkt Ausführung: H+Ö / Ö+Ö / H+H turnbuckle acc. DIN 1480 made from steel, zinc plated model: h+h / o+o / h+h</p> | 1480-M30 | 250,2 | 28,5 | 29,6 | 334,5 |
| | 1480-M24 | 122,0 | 28,0 | 27,0 | 215,0 |
| | 1480-M20 | 198,0 | 24,0 | 21,0 | 156,0 |
| | 1480-M18 | 189,0 | 22,0 | 21,0 | 87,6 |
| | 1480-M14 | 139,5 | 17,7 | 17,1 | 81,5 |
| | 1480-M12 | 123,2 | 17,0 | 16,2 | 35,7 |
| | 1480-M10 | 123,7 | 15,2 | 11,6 | 24,6 |
| | 1480-M8 | 108,6 | 10,8 | 10,5 | 12,4 |
| | 1480-M6 | 108,7 | 8,9 | 8,6 | 8,2 |
| 3011-Z | | | | | |
|  <p>Wartenspanner ähnlich DIN 1478 aus Stahl, verzinkt rigging screw acc. DIN 1478 made from steel, zinc plated</p> | 3011-Z-M16 | 228,0 | 20,0 | | 140,0 |
| | 3011-Z-M12 | 124,7 | 18,4 | | 89,8 |
| | 3011-Z-M10 | 131,3 | 12,6 | | 42,3 |
| | 3011-Z-M8 | 109,8 | 10,5 | | 27,1 |
| | 3011-Z-M6 | 113,7 | 6,6 | | 19,9 |
| 15315 | | | | | |
|  <p>Seilschloß ähnlich DIN 15315 aus Stahl, verzinkt rope socket acc. DIN 15315 made from steel, zinc plated</p> | 15315 NG5 | 3,4 | 11,0 | 109,8 | 21,3 |

Simplex-, Duplex-, Eiform- und Drehtseilklemmen, Seilschloß, Spannschlösser, Wantenspanner, Kauschen sowie Achten mit Klappe aus Stahl, verzinkt, Pressklemmen aus Aluminium

simplex- and duplex clamps, egg shaped wire rope clips, wire rope clips, rope socket, turnbuckles, rigging screws, thimbles, rope shortenings with blocking made from steel, zinc plated, at alloy ferrules

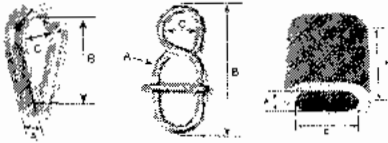

D = Gewicht (kg) bei 100 Stück
weight (kgs) per 100 pieces

Alle Maße in mm
all measurements in mm

| Art.-Nr. / item no. 840 | Art.-Nr. / item no. | A | B | C | D |
|---|---------------------|------|------|------|------|
|  Kausche ähnlich B-DIN 6899 aus Stahl, verzinkt thimble acc. B-DIN 6899 made from steel, zinc plated | 840-20 | 20,4 | 73,7 | 45,4 | 28,7 |
| | 840-18 | 17,3 | 65,8 | 40,7 | 21,8 |
| | 840-16 | 16,3 | 57,3 | 36,0 | 12,0 |
| | 840-14 | 14,1 | 51,0 | 32,0 | 8,9 |
| | 840-12 | 12,6 | 43,3 | 28,8 | 6,2 |
| | 840-10 | 10,8 | 37,4 | 24,0 | 3,8 |
| | 840-8 | 8,4 | 35,5 | 20,3 | 3,5 |
| | 840-6 | 6,5 | 28,5 | 17,8 | 1,0 |
| | 840-5 | 5,6 | 23,5 | 13,9 | 0,7 |
| | 840-4 | 4,4 | 20,1 | 12,7 | 0,6 |
| 840-3 | 3,4 | 18,0 | 11,0 | 0,4 | |

| Art.-Nr. / item no. 842 | Art.-Nr. / item no. | A | B | C | D |
|---|---------------------|------|------|------|------|
|  Kausche ähnlich DIN 65457 (ehemals A-DIN 6899) aus Stahl, verzinkt thimble acc. DIN 65457 (once A-DIN 6899) made from steel, zinc plated | 842-20 | 20,4 | 86,8 | 42,2 | 27,0 |
| | 842-18 | 18,1 | 77,0 | 36,5 | 18,8 |
| | 842-16 | 16,1 | 68,2 | 34,5 | 10,5 |
| | 842-14 | 14,0 | 61,0 | 28,0 | 7,3 |
| | 842-12 | 12,3 | 51,8 | 25,8 | 3,6 |
| | 842-10 | 10,1 | 42,7 | 21,2 | 1,7 |
| | 842-8 | 8,1 | 38,2 | 18,3 | 2,0 |
| | 842-6 | 6,1 | 30,4 | 15,3 | 0,9 |
| | 842-5 | 5,1 | 28,3 | 13,0 | 0,5 |
| | 842-4 | 4,0 | 26,2 | 13,1 | 0,4 |
| 842-3 | 2,0 | 21,1 | 10,4 | 0,2 | |

| Art.-Nr. / item no. 3A | Art.-Nr. / item no. | A | B | C | D |
|--|---------------------|-----|-------|------|------|
|  Acht mit Klappe aus Stahl, verzinkt rope shortening with blocking made from steel, zinc plated | 3A-10x100 | 9,9 | 100,6 | 22,0 | 14,6 |
| | 3A-8x90 | 8,8 | 90,3 | 18,0 | 11,2 |
| | 3A-8x80 | 7,7 | 81,0 | 18,2 | 7,8 |
| | 3A-7x75 | 6,7 | 74,5 | 15,9 | 5,6 |
| | 3A-6x70 | 5,8 | 70,5 | 16,2 | 3,9 |
| | 3A-6x60 | 5,8 | 61,4 | 15,2 | 3,5 |

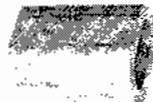

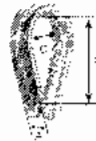
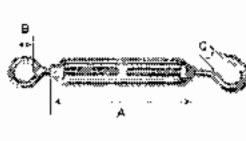

| Art.-Nr. / item no. 3093 | Art.-Nr. / item no. | A | B | C | D |
|--|---------------------|------|-----|------|-----|
|  Alupressklemme alloy ferrule made from aluminium | 3093-14,0 | 15,3 | 49 | 30,6 | 7,0 |
| | 3093-12,0 | 13,2 | 42 | 26,4 | 4,1 |
| | 3093-11,0 | 12,1 | 38 | 24,2 | 3,3 |
| | 3093-10,0 | 10,9 | 35 | 21,8 | 2,4 |
| | 3093-8,0 | 8,8 | 28 | 17,6 | 1,1 |
| | 3093-6,0 | 6,6 | 21 | 13,2 | 0,4 |
| | 3093-5,0 | 5,5 | 18 | 11,0 | 0,3 |
| | 3093-4,0 | 4,4 | 14 | 8,8 | 0,2 |
| | 3093-3,0 | 3,3 | 11 | 6,6 | 0,1 |
| 3093-2,0 | 2,4 | 7 | 4,8 | 0,05 | |

**Simplex-, Duplex- und Drahtseilklemmen,
Spannschlösser, Wartenspanner und Kauschen aus Edelstahl**
simplex- and duplex clamps, wire rope clips, turnbuckles, rigging screws
and thimbles made from stainless steel

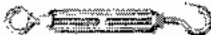

D = Gewicht (kg) bei 100 Stück
weight (kgs) per 100 pieces

Alle Maße in mm
all measurements in mm

| Art.-Nr. / item no. | | Art.-Nr. / item no. | A | B | C | D |
|---|---|---------------------|-------|------|------|-------|
| 103-I | | | | | | |
|  | Simplexklemme aus Edelstahl AISI 316 | 103-I-8 | 9,5 | 37,8 | 22,9 | 4,5 |
| | | 103-I-6 | 8,7 | 29,8 | 15,5 | 1,9 |
| | | 103-I-5 | 8,6 | 24,0 | 13,5 | 1,0 |
| | | 103-I-4 | 8,0 | 21,1 | 11,5 | 0,8 |
| | | 103-I-3 | 6,8 | 18,0 | 10,5 | 0,5 |
| | | 103-I-2 | 6,6 | 17,8 | 9,7 | 0,4 |
| | <i>simplex clamp made from stainless steel AISI 316</i> | | | | | |
| 104-I | | | | | | |
|  | Duplexklemme aus Edelstahl AISI 316 | 104-I-8 | 9,6 | 74,9 | 23,8 | 9,4 |
| | | 104-I-6 | 9,3 | 59,9 | 17,5 | 4,4 |
| | | 104-I-5 | 8,6 | 47,9 | 13,6 | 2,3 |
| | | 104-I-4 | 6,8 | 40,2 | 11,2 | 2,0 |
| | | 104-I-3 | 6,3 | 40,3 | 10,2 | 1,2 |
| | | 104-I-2 | 4,4 | 35,7 | 7,4 | 0,8 |
| | <i>duplex clamp made from stainless steel AISI 316</i> | | | | | |
| 400-I | | | | | | |
|  | Drahtseilklemme aus Edelstahl AISI 316 | 400-I-16 | 19,7 | 58,3 | 16,8 | 19,4 |
| | | 400-I-12 | 15,0 | 56,0 | 16,8 | 17,7 |
| | | 400-I-10 | 10,9 | 46,1 | 12,8 | 9,1 |
| | | 400-I-8 | 10,2 | 37,7 | 9,8 | 5,3 |
| | | 400-I-6 | 8,3 | 27,6 | 7,7 | 1,8 |
| | | 400-I-5 | 6,7 | 23,5 | 7,7 | 1,5 |
| | | 400-I-4 | 5,7 | 25,7 | 7,7 | 1,4 |
| | | 400-I-3 | 5,0 | 21,3 | 6,8 | 1,1 |
| | 400-I-2 | 4,7 | 18,1 | 5,4 | 0,6 | |
| | <i>wire rope clip made from stainless steel AISI 316</i> | | | | | |
| 3010-I | | | | | | |
|  | Spannschloß aus Edelstahl AISI 316 | 3010-I-18 | 248,2 | 22,3 | 16,5 | 111,0 |
| | | 3010-I-12 | 200,0 | 20,2 | 15,6 | 51,2 |
| | | 3010-I-10 | 150,3 | 18,3 | 12,6 | 27,5 |
| | | 3010-I-8 | 119,7 | 13,8 | 11,2 | 15,8 |
| | | 3010-I-6 | 90,2 | 10,2 | 9,8 | 7,7 |
| | | 3010-I-5 | 71,5 | 9,7 | 6,8 | 4,1 |
| | <i>turnbuckle made from stainless steel AISI 316 model: h+o / o+o / h+h</i> | | | | | |
| 3011-I | | | | | | |
|  | Wartenspanner aus Edelstahl AISI 316 | 3011-I-18 | 355,0 | 18,0 | 18,0 | |
| | | 3011-I-12 | 124,6 | 11,7 | 11,7 | 40,8 |
| | | 3011-I-10 | 125,7 | 11,6 | 11,6 | 32,5 |
| | | 3011-I-8 | 105,6 | 9,4 | 9,4 | 17,2 |
| | | 3011-I-6 | 92,8 | 7,7 | 7,7 | 11,1 |
| | | 3011-I-5 | 78,1 | 7,6 | 7,6 | 4,7 |
| | <i>rigging screw made from stainless steel AISI 316</i> | | | | | |
| 844-I | | | | | | |
|  | Kausche aus Edelstahl AISI 316 | 844-I-8 | 8,1 | 31,8 | 19,2 | 1,5 |
| | | 844-I-6 | 6,1 | 25,0 | 15,3 | 0,8 |
| | | 844-I-5 | 5,1 | 22,5 | 13,4 | 0,5 |
| | | 844-I-4 | 4,1 | 18,5 | 10,7 | 0,4 |
| | | 844-I-3 | 3,1 | 16,8 | 10,3 | 0,3 |
| | | 844-I-2 | 2,1 | 17,6 | 6,8 | 0,2 |
| | <i>thimble made from stainless steel AISI 316</i> | | | | | |

Wirbel aus Temperguß und Zinkdruckguß
 swivels made from malleable cast iron and zinc die cast

D = Gewicht (kg) bei 100 Stück
 weight (kgs) per 100 pieces

Alle Maße in mm
 all measurements in mm



| Art.-Nr. / item no. | Art.-Nr. / item-no. | A | B | C | D | |
|---|--|---------------------|-----------------|----------------|-----------------|----------------|
| 163 | | | | | | |
|  | Wirbel aus Zinkdruckguß, vernickelt | 163-11x13 | 13,1 | 11,2 | 38,8 | 1,5 |
| | | 163-9x16 | 16,2 | 8,9 | 47,4 | 2,0 |
| | | 163-9x13 | 13,2 | 8,9 | 42,8 | 1,5 |
| swivel made from zinc die cast, nickel plated | | | | | | |

| Art.-Nr. / item no. | Art.-Nr. / item-no. | A | B | C | D | |
|---|-------------------------------------|---------------------|-----------------|-----------------|-----------------|----------------|
| 166 | | | | | | |
|  | Wirbel aus Temperguß, vernickelt | * 166-60 | 26,3 | 12,3 | 83,3 | 10,6 |
| | | * 166-70 | 18,0 | 19,7 | 70,0 | 4,8 |
| | | * 166-60 | 18,2 | 11,0 | 60,7 | 4,8 |
| | | * 166-45 | 14,0 | 7,9 | 48,6 | 2,9 |
| | | 166-30 | 10,6 | 5,8 | 42,5 | 2,1 |
| swivel made from malleable cast iron, nickel plated | | | | | | |

| Art.-Nr. / item no. | Art.-Nr. / item-no. | A | B | C | D | |
|---|--|-----------------------|-----------------|-----------------|-----------------|----------------|
| 173-Z | | | | | | |
|  | Wirbel aus Zinkdruckguß, vernickelt | 173-Z-1" | 26,3 | 26,3 | 50,5 | 3,5 |
| | | 173-Z-7/8" | 22,6 | 22,6 | 49,6 | 3,5 |
| | | 173-Z-3/4" | 19,5 | 19,5 | 48,4 | 3,0 |
| | | 173-Z-5/8" | 18,8 | 18,8 | 48,7 | 3,0 |
| swivel made from zinc die cast, nickel plated | | | | | | |

| Art.-Nr. / item no. | Art.-Nr. / item-no. | A | B | C | D | |
|---|--|------------|------|------|------|-----|
| 175-Z | | | | | | |
|  | Wirbel aus Zinkdruckguß, vernickelt | 175-Z-1" | 25,0 | 25,0 | 78,0 | 4,8 |
| | | 175-Z-3/4" | 20,4 | 20,4 | 70,3 | 3,6 |
| | | 175-Z-5/8" | 16,5 | 16,5 | 62,1 | 3,5 |
| | | 175-Z-1/2" | 12,2 | 12,2 | 58,8 | 3,0 |
| | | 175-Z-3/8" | 12,1 | 12,1 | 54,1 | 2,0 |
| swivel made from zinc die cast, nickel plated | | | | | | |

| Art.-Nr. / item no. | Art.-Nr. / item-no. | A | B | C | D | |
|---|--|------------|------|------|------|-----|
| 7931 | | | | | | |
|  | Wirbel aus Zinkdruckguß, vernickelt | 7931-25x25 | 25,0 | 25,0 | 62,0 | 4,2 |
| | | 7931-25x20 | 26,1 | 20,4 | 60,6 | 4,0 |
| | | 7931-20x25 | 18,4 | 25,6 | 64,6 | 4,0 |
| | | 7931-20x20 | 20,5 | 20,7 | 60,4 | 4,0 |
| swivel made from zinc die cast, nickel plated | | | | | | |

Wirbel aus Messing
 swivels made from solid brass

D = Gewicht (kg) bei 100 Stück
 weight (kgs) per 100 pieces

Alle Maße in mm
 all measurements in mm

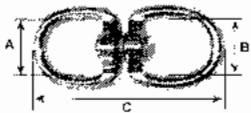

| Art.-Nr. / item no. | Art.-Nr. / item-no. | A | B | C | D | |
|---|---------------------|---------------------|----------------|----------------|-----------------|----------------|
| 167-B | | | | | | |
|  | Wirbel aus Messing | 167-B-90 | 13,5 | 13,5 | 93,7 | 7,5 |
| | | 167-B-60 | 8,0 | 8,0 | 69,0 | 2,6 |
| swivel made from solid brass | | | | | | |

| Art.-Nr. / item no. | Art.-Nr. / item-no. | A | B | C | D | |
|---|---------------------|------------|------|------|------|-----|
| 178-B | | | | | | |
|  | Wirbel aus Messing | 178-B-5/8" | 17,0 | 17,0 | 69,0 | 5,7 |
| swivel made from solid brass | | | | | | |

Wirbel aus Edelstahl
swivels made from stainless steel

D = Gewicht (kg) bei 100 Stück
weight (kgs) per 100 pieces

Alle Maße in mm
all measurements in mm

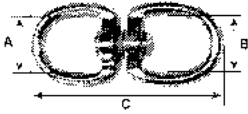

| Art.-Nr. / item no. | Art.-Nr. / item-no. | A | B | C | D |
|---|---|------|------|-------|------|
| 7990-1 | Wirbel aus Edelstahl AISI 316 | | | | |
|  | swivel made from stainless steel AISI 316 | | | | |
| | 7990-I-10 | 24,3 | 24,3 | 116,9 | 25,5 |
| | 7990-I-8 | 20,2 | 20,2 | 89,4 | 19,0 |
| | 7990-I-6 | 15,0 | 15,0 | 66,5 | 6,1 |
| | 7990-I-5 | 13,9 | 13,0 | 59,9 | 3,9 |

| Art.-Nr. / item no. | Art.-Nr. / item-no. | A | B | C | D |
|---|---|------|------|-------|------|
| 7992-1 | Wirbel-Schäkel aus Edelstahl AISI 316 | | | | |
|  | swivel-shackle made from stainless steel AISI 316 | | | | |
| | 7992-I-10 | 23,6 | 19,4 | 117,4 | 30,5 |

Blockseil- und Vogelrollen aus Stahl
 pulleys and bird pulleys made from steel

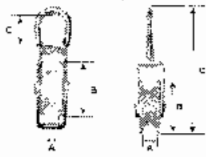

D = Gewicht (kg) bei 100 Stück
 weight (kgs) per 100 pieces

Alle Maße in mm
 all measurements in mm

| Art.-Nr. / item no. | Art.-Nr. / item no. | A | B | C | D | |
|---|---|---------------|------|------|------|------|
| 502  | Blockseilrolle aus Stahl verzinkt mit fester Öse, Nylonrolle | 502-50 | 11,2 | 49,5 | 25,7 | 23,8 |
| | | 502-40 | 9,6 | 40,0 | 22,8 | 18,2 |
| | | 502-30 | 8,6 | 30,6 | 19,8 | 9,6 |
| | | 502-25 | 7,7 | 25,0 | 17,2 | 6,7 |
| | | 502-20 | 6,8 | 20,1 | 15,8 | 4,0 |
| | | 502-15 | 6,2 | 15,1 | 13,6 | 2,1 |

pulley made from steel, zinc plated with fixed eye, with nylon sheave

| Art.-Nr. / item no. | Art.-Nr. / item no. | A | B | C | D | |
|---|---|---------------|-----|------|------|------|
| 503  | Blockseilrolle aus Stahl verzinkt mit zwei festen Ösen, Nylonrolle | 503-30 | 9,1 | 30,2 | 14,4 | 12,4 |

pulley made from steel zinc plated with two fixed eyes and nylon sheave

| Art.-Nr. / item no. | Art.-Nr. / item no. | A | B | C | D | |
|--|---|---------------|------|------|------|------|
| 504  | Blockseilrolle aus Stahl verzinkt mit fester Öse, zwei Nylonrollen | 504-50 | 11,8 | 50,0 | 25,5 | 29,9 |
| | | 504-40 | 9,4 | 40,0 | 22,8 | 20,4 |
| | | 504-30 | 6,6 | 30,7 | 20,0 | 15,0 |
| | | 504-25 | 7,5 | 24,5 | 17,3 | 8,3 |
| | | 504-20 | 6,4 | 20,1 | 15,0 | 5,7 |
| | | 504-15 | 5,5 | 15,2 | 13,7 | 3,3 |

pulley made from steel, zinc plated with fixed eye, two nylon sheaves

| Art.-Nr. / item no. | Art.-Nr. / item no. | A | B | C | D | |
|---|--|---------------|------|------|------|------|
| 505  | Blockseilrolle aus Stahl verzinkt mit drehb. Öse, Rolle aus Nylon | 505-50 | 12,0 | 50,0 | 22,4 | 18,3 |
| | | 505-40 | 10,5 | 39,8 | 21,4 | 12,7 |
| | | 505-30 | 8,7 | 30,0 | 17,1 | 7,6 |
| | | 505-25 | 7,3 | 25,0 | 15,7 | 5,5 |
| | | 505-20 | 6,4 | 20,0 | 13,2 | 4,3 |
| | | 505-15 | 5,5 | 15,0 | 10,5 | 2,7 |

pulley made from steel, zinc plated with movable eye, with nylon sheave

| Art.-Nr. / item no. | Art.-Nr. / item no. | A | B | C | D | |
|---|---|---------------|------|------|-------|-----|
| 507  | Vogelrolle aus Stahl verzinkt mit Schraubgewinde, Nylonrolle | 507-50 | 11,5 | 50,4 | 117,0 | 8,5 |
| | | 507-30 | 8,2 | 30,0 | 88,1 | 3,8 |

bird pulley made from steel zinc plated with screw and nylon sheave

| Art.-Nr. / item no. | Art.-Nr. / item no. | A | B | C | D | |
|--|--|------------------|-----|------|-------|------|
| 507-GR  | Vogelrolle aus Stahl verzinkt mit Schraubgewinde, Gussrolle | 507-50 GR | 5,6 | 49,7 | 115,8 | 18,2 |
| | | 507-30 GR | 5,0 | 30,0 | 87,9 | 6,7 |

bird pulley made from steel zinc plated with screw and cast sheave

Blockseil- und Vogelrollen aus Stahl
 pulleys and bird pulleys made from steel

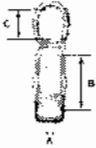

D = Gewicht (kg) bei 100 Stück
 weight (kgs) per 100 pieces

Alle Maße in mm
 all measurements in mm

| Art.-Nr. / item no. | Art.-Nr. / item no. | A | B | C | D |
|---------------------|---------------------|---|---|---|---|
|---------------------|---------------------|---|---|---|---|



Blockseilrolle aus Stahl
 vernickelt mit fester Öse,
 Messingrolle

7310-1 1/2" 9,5 35,2 10,5 13,3

~~7310-1" 7,8 28,9 5,8 5,8~~

pulley made from steel, nickel plated with fixed eye and brass sheave

| Art.-Nr. / item no. | Art.-Nr. / item no. | A | B | C | D |
|---------------------|---------------------|---|---|---|---|
|---------------------|---------------------|---|---|---|---|



Blockseilrolle aus Stahl
 vernickelt mit fester Öse,
 zwei Messingrollen

7320-1 1/2" 9,6 35,1 10,4 22,8

~~7320-1" 5,3 23,8 6,4 8,6~~

pulley made from steel, nickel plated with fixed eye and brass sheave

| Art.-Nr. / item no. | Art.-Nr. / item no. | A | B | C | D |
|---------------------|---------------------|---|---|---|---|
|---------------------|---------------------|---|---|---|---|



Blockseilrolle aus Stahl
 verchromt mit fester Öse,
 Bronzerolle

8310-1 1/4" 7,1 32,5 9,7 12,8

~~8310-3/4" 5,6 17,5 8,7 8,6~~

pulley made from steel, chrome plated with fixed eye and bronze sheave

Blockseilrollen aus Edelstahl
 pulleys made from stainless steel

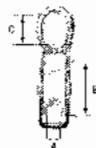

D = Gewicht (kg) bei 100 Stück
 weight (kgs) per 100 pieces

Alle Maße in mm
 all measurements in mm

| Art.-Nr. / item no. | Art.-Nr. / item no. | A | B | C | D |
|---------------------|---------------------|---|---|---|---|
|---------------------|---------------------|---|---|---|---|



Blockseilrolle aus Edelstahl
 AISI 304

8253-1-S 5,0 29,5 13,5 3,7

pulley made from stainless steel AISI 304

Sonstiges Seilzubehör aus Stahl
miscellaneous rope accessories made from steel

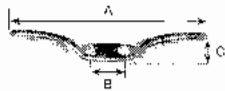
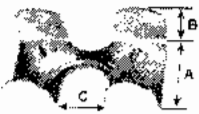

D = Gewicht (kg) bei 100 Stück
weight (kgs) per 100 pieces

Alle Maße in mm
all measurements in mm

| Art.-Nr. / Item no. | Art.-Nr. / Item no. | A | B | C | D | |
|---|--|-----------------------|-----------------|-----------------|-----------------|----------------|
| 16-ST  | Seilklammer aus Stahl, vernickelt | 16-ST-5/8" | 25,3 | 18,0 | 15,5 | 1,5 |
| | <i>rope clamp made from steel, nickel plated</i> | 16-ST-1/2" | 21,5 | 16,0 | 12,0 | 1,1 |

| Art.-Nr. / Item no. | Art.-Nr. / Item no. | A | B | C | D | |
|--|--|-----------------------|------------------|-----------------|-----------------|----------------|
| 4015-Z  | Seilklammer aus Zinkdruckguß, vernickelt | 4015-Z-153 | 154,8 | 24,7 | 16,5 | 6,0 |
| | <i>rope clamp made from zinc die cast, nickel plated</i> | 4015-Z-112 | 112,5 | 20,4 | 15,1 | 5,6 |
| | | 4015-Z-62 | 62,8 | 10,3 | 8,5 | 1,0 |

Sonstiges Seilzubehör aus Messing
miscellaneous rope accessories made from solid brass

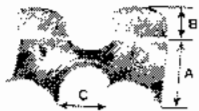

D = Gewicht (kg) bei 100 Stück
weight (kgs) per 100 pieces

Alle Maße in mm
all measurements in mm

| Art.-Nr. / Item no. | Art.-Nr. / Item no. | A | B | C | D | |
|---|---|-------------------|------|------|------|-----|
| HRC-B  | Seilklammer aus Messing | HRC B 7/8" | 24,0 | 24,2 | 14,9 | 5,2 |
| | <i>rope clamp made from solid brass</i> | | | | | |

Ringschrauben und Ringmuttern aus Stahl

eye nuts and eye screws made from steel

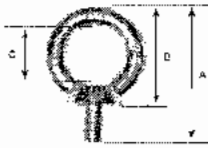

D = Gewicht (kg) bei 100 Stück
weight (kgs) per 100 pieces

Alle Maße in mm
all measurements in mm

| Art.-Nr. / item no. 580 | Art.-Nr. / item-no. | A | B | C | D |
|--|---------------------|-------|------|------|------|
|  Ringschraube ähnlich DIN 580 aus Stahl, verzinkt eye screw acc. DIN 580 made from steel, zinc plated | 580-M 24 | 129,7 | 83,4 | 50,0 | 87,1 |
| | 580-M 20 | 100,0 | 70,9 | 39,0 | 49,8 |
| | 580-M 16 | 90,5 | 64,0 | 33,0 | 27,7 |
| | 580-M 14 | 81,1 | 64,7 | 34,0 | 28,2 |
| | 580-M 12 | 73,5 | 53,5 | 28,6 | 16,3 |
| | 580-M 10 | 62,7 | 45,8 | 23,7 | 11,2 |
| | 580-M 8 | 49,8 | 37,6 | 18,7 | 6,0 |
| | 580-M 6 | 50,8 | 38,0 | 18,7 | 5,4 |

| Art.-Nr. / item no. 582 | Art.-Nr. / item-no. | A | B | C | D |
|--|---------------------|---|------|------|------|
|  Ringmutter ähnlich DIN 582 aus Stahl, verzinkt eye nut acc. DIN 582 made from steel, zinc plated | 582-M 24 | | 80,0 | 48,5 | 72,2 |
| | 582-M 20 | | 72,2 | 37,8 | 39,9 |
| | 582-M 16 | | 62,2 | 33,0 | 23,5 |
| | 582-M 14 | | 63,5 | 34,8 | 23,5 |
| | 582-M 12 | | 53,3 | 28,4 | 15,2 |
| | 582-M 10 | | 43,8 | 23,7 | 8,0 |
| | 582-M 8 | | 36,5 | 18,6 | 4,7 |
| | 582-M 6 | | 35,5 | 18,8 | 4,3 |

Ringschrauben und Ringmuttern aus Edelstahl

eye nuts and eye screws made from stainless steel



D = Gewicht (kg) bei 100 Stück
weight (kgs) per 100 pieces

Alle Maße in mm
all measurements in mm

| Art.-Nr. / item no. 580-I | Art.-Nr. / item-no. | A | B | C | D |
|---|---------------------|------|------|------|------|
|  Ringschraube ähnlich DIN 580 aus Edelstahl AISI 316 eye screw acc. DIN 580 made from stainless steel AISI 316 | 580-I-12 | 75,1 | 52,9 | 28,6 | 16,7 |
| | 580-I-10 | 61,2 | 45,2 | 25,2 | 9,1 |
| | 580-I-8 | 51,2 | 36,0 | 20,2 | 4,8 |
| | 580-I-6 | 43,4 | 31,0 | 15,8 | 2,5 |

| Art.-Nr. / item no. 582-I | Art.-Nr. / item-no. | A | B | C | D |
|---|---------------------|---|------|------|------|
|  Ringmutter ähnlich DIN 582 aus Edelstahl AISI 316 eye nut acc. DIN 582 made from stainless steel AISI 316 | 582-I-12 | | 63,0 | 28,0 | 17,3 |
| | 582-I-10 | | 44,5 | 23,9 | 8,2 |
| | 582-I-8 | | 35,3 | 18,0 | 4,0 |
| | 582-I-6 | | 30,6 | 17,5 | 3,9 |

Ösenschrauben, Decken- und Schaukelhaken aus Stahl
 eye screws, ceiling- and hammock hooks made from steel

D = Gewicht (kg) bei 100 Stück
 weight (kgs) per 100 pieces

Alle Maße in mm
 all measurements in mm

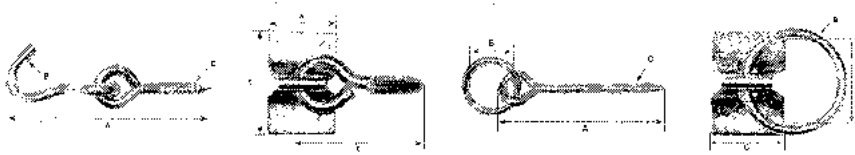

| Art.-Nr. / item no. | Art.-Nr. / item no. | A | B | C | D |
|---------------------|---------------------|---|---|---|---|
| 27H | | | | | |

Hängemattenhaken mit Holzgewinde aus Stahl, verzinkt



hammock hook with wooden thread made from steel, zinc plated

| | | | | |
|-----|-------|-----|-----|------|
| 27H | 165,0 | 9,5 | M12 | 18,0 |
|-----|-------|-----|-----|------|

| Art.-Nr. / item no. | Art.-Nr. / item no. | A | B | C | D |
|---------------------|---------------------|---|---|---|---|
| 37H | | | | | |

Hängemattenhaken mit Platte aus Stahl, verzinkt



hammock hook with plate made from steel, zinc plated

| | | | | |
|---------|------|------|------|------|
| 37H/C-4 | 45,0 | 65,6 | 91,5 | 18,4 |
|---------|------|------|------|------|

| Art.-Nr. / item no. | Art.-Nr. / item no. | A | B | C | D |
|---------------------|---------------------|---|---|---|---|
| 42A | | | | | |

Ösenschraube aus Stahl mit Ring, verzinkt



eye screw with ring made from steel zinc plated

| | | | | |
|------------|-------|------|-----|------|
| 42A-130 HG | 170,0 | 45,0 | M12 | 22,0 |
|------------|-------|------|-----|------|

| | | | | |
|-----------|-------|------|-----|------|
| 42A-70 HG | 120,0 | 45,0 | M12 | 17,5 |
|-----------|-------|------|-----|------|

| Art.-Nr. / item no. | Art.-Nr. / item no. | A | B | C | D |
|---------------------|---------------------|---|---|---|---|
| 42A-E | | | | | |

Ösenschraube aus Stahl mit Ring, verzinkt



eye screw with ring made from steel zinc plated

| | | | | |
|--------------|-------|------|-----|------|
| 42A-E/130 EG | 170,0 | 45,0 | M12 | 22,0 |
|--------------|-------|------|-----|------|

| | | | | |
|-------------|-------|------|-----|------|
| 42A-E/70 EG | 120,0 | 45,0 | M12 | 17,5 |
|-------------|-------|------|-----|------|

| Art.-Nr. / item no. | Art.-Nr. / item no. | A | B | C | D |
|---------------------|---------------------|---|---|---|---|
| 7 | | | | | |

Deckenhaken m. Kunststoffbuchse aus Stahl, verzinkt



ceiling hook with plastic bush made from steel, zinc plated

| | | | | |
|---------------|-------|------|-----|------|
| 7-10,6x180 EG | 180,0 | 30,0 | M12 | 24,0 |
|---------------|-------|------|-----|------|

| | | | | |
|---------------|-------|------|-----|------|
| 7-10,6x180 HG | 180,0 | 30,0 | M12 | 24,0 |
|---------------|-------|------|-----|------|

| Art.-Nr. / item no. | Art.-Nr. / item no. | A | B | C | D |
|---------------------|---------------------|---|---|---|---|
| 8 | | | | | |

Deckenhaken aus Stahl, verzinkt



ceiling hook made from steel, zinc plated

| | | | | |
|---------------|-------|------|-----|------|
| 8-10,6x145 HG | 145,0 | 30,0 | M12 | 18,0 |
|---------------|-------|------|-----|------|

| | | | | |
|---------------|-------|------|-----|------|
| 8-10,6x133 HG | 133,0 | 30,0 | M12 | 15,0 |
|---------------|-------|------|-----|------|

| | | | | |
|--------------|-------|------|-----|------|
| 8-8,8x145 HG | 145,0 | 30,0 | M10 | 10,0 |
|--------------|-------|------|-----|------|

| | | | | |
|--------------|-------|------|-----|-----|
| 8-8,8x140 EG | 140,0 | 30,0 | M10 | 8,5 |
|--------------|-------|------|-----|-----|

| Art.-Nr. / item no. | Art.-Nr. / item no. | A | B | C | D |
|---------------------|---------------------|---|---|---|---|
| 8481 | | | | | |

Anbindung mit Platte aus Stahl verzinkt



plate hitching ring made from steel, zinc plated

| | | | | |
|------|------|-----|------|-----|
| 8481 | 50,7 | 6,9 | 45,0 | 8,5 |
|------|------|-----|------|-----|

Sonstige Befestigungsmittel aus Stahl
miscellaneous fittings made from steel

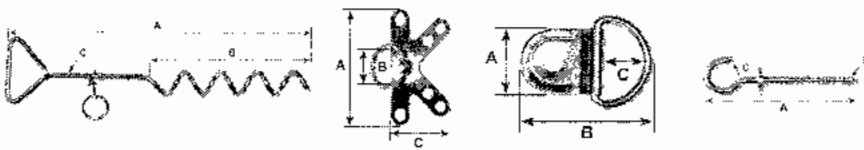

D = Gewicht (kg) bei 100 Stück
weight (kgs) per 100 pieces

Alle Maße in mm
all measurements in mm

| Art.-Nr. / item no. | Art.-Nr. / item-no. | A | B | C | D |
|---------------------|---------------------|---|---|---|---|
|---------------------|---------------------|---|---|---|---|

047

Anbindepflock aus Stahl, verchromt

047-8x16"

410,0 240,0 7,8 31,5

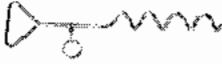

pic out staka made from steel, chrome plated

| Art.-Nr. / item no. | Art.-Nr. / item-no. | A | B | C | D |
|---------------------|---------------------|---|---|---|---|
|---------------------|---------------------|---|---|---|---|

0848

K-Schild aus Stahl, vernickelt

0848-7

52,0 16,0 26,7 1,0



k-halter made from steel, nickel plated

| Art.-Nr. / item no. | Art.-Nr. / item-no. | A | B | C | D |
|---------------------|---------------------|---|---|---|---|
|---------------------|---------------------|---|---|---|---|

1954

Clip mit D-Ring aus Stahl, vernickelt

1954-1"

22,0 83,0 26,7 3,7



clip and D-ring made from steel, nickel plated

1954-3/4"

16,8 48,4 15,0 0,9

1954-3/4" kurz

18,0 37,7 14,6 0,8

1954-5/8"

18,8 33,5 10,2 0,9

| Art.-Nr. / item no. | Art.-Nr. / item-no. | A | B | C | D |
|---------------------|---------------------|---|---|---|---|
|---------------------|---------------------|---|---|---|---|

315

Flügelmutter ähnlich DIN 315 aus Stahl, verzinkt

315-M12

1,6

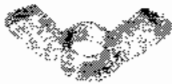

wing nut acc. DIN 315 made from steel, zinc plated

315-M10

1,3

315-M8

0,6

315-M6

0,4

315-M5

0,3

315-M4

0,2

315-M3

0,1

| Art.-Nr. / item no. | Art.-Nr. / item-no. | A | B | C | D |
|---------------------|---------------------|---|---|---|---|
|---------------------|---------------------|---|---|---|---|

465

Hakenschraube aus Stahl, verzinkt

465

89,2 4,8 10,7 1,7



hook made from steel, zinc plated

| Art.-Nr. / item no. | Art.-Nr. / item-no. | A | B | C | D |
|---------------------|---------------------|---|---|---|---|
|---------------------|---------------------|---|---|---|---|

TZU

Brazilfeder aus Stahl, verzinkt

TZU-12080

215,0 25,0 6,0 66,0

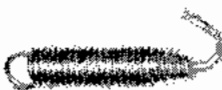

Brazil-spring made from steel, zinc plated

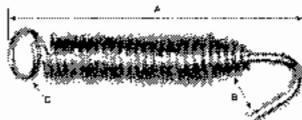

Sonstige Befestigungsmittel aus Messing
miscellaneous fittings made from solid brass

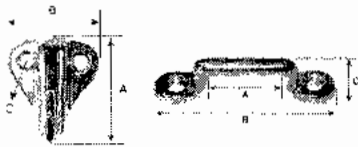

D = Gewicht (kg) bei 100 Stück
weight (kgs) per 100 pieces

Alle Maße in mm
all measurements in mm

| Art.-Nr. / Item no. | Art.-Nr. / Item no. | A | B | C | D |
|---|--|------|------|-----|-----|
| 10-2002 | 10-2002 | 35,8 | 32,2 | 4,0 | 3,7 |
|  | Fenderhaken aus Messing, verchromt fender hook made from solid brass, chrome plated | | | | |

| Art.-Nr. / Item no. | Art.-Nr. / Item no. | A | B | C | D |
|---|--|--------------|--------------|--------------|------------|
| 66431 | 66431-40 | 39,0 | 78,8 | 17,4 | 2,8 |
|  | 66431-26 66431-20 | 26,0 20,0 | 63,8 55,6 | 15,7 14,5 | 2,3 1,5 |
| | Krampen aus Messing staples made from solid brass | | | | |

Sonstige Befestigungsmittel aus Edelstahl
miscellaneous fittings made from stainless steel

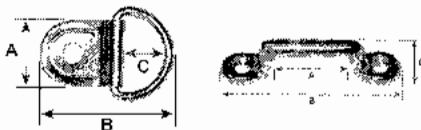

D = Gewicht (kg) bei 100 Stück
weight (kgs) per 100 pieces

Alle Maße in mm
all measurements in mm

| Art.-Nr. / Item no. | Art.-Nr. / Item no. | A | B | C | D |
|---|--|------|------|------|-----|
| 1954-1 | 1954-1-3/4" | 17,0 | 47,0 | 15,1 | 1,0 |
|  | Clip mit D-Ring aus Edelstahl AISI 304 clip with D-ring made from stainless steel, AISI 304 | | | | |

| Art.-Nr. / Item no. | Art.-Nr. / Item no. | A | B | C | D |
|---|--|--------------|--------------|--------------|------------|
| 66432-1 | 66432-1-36 | 35,8 | 71,0 | 14,5 | 1,7 |
|  | 66432-1-20 66432-1-26 | 32,0 24,6 | 70,4 64,6 | 14,4 13,6 | 1,6 1,5 |
| | Krampen aus Edelstahl AISI 304 staples made from stainless steel AISI 304 | | | | |

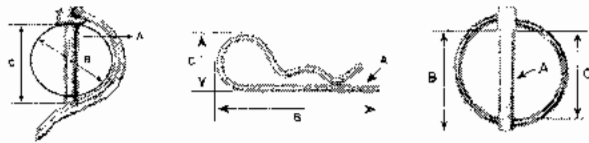

Klappsplinte, Rohrklappstecker und Federstecker aus Stahl

folding up pins, pipe pins and spiral pins made from steel

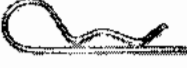
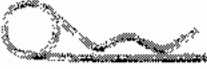

*D = Gewicht (kg) bei 100 Stück
weight (kg) per 100 pieces*

*Alle Maße in mm
all measurements in mm*

| Art.-Nr. / item no. | Art.-Nr. / item no. | A | B | C | D |
|--|------------------------------|-----------------|------------------|-----------------|----------------|
| 13... | Art.-Nr. / item no. | | | | |
|  Rohrklappstecker aus Stahl, verzinkt <i>pipe pin made from steel, zinc plated</i> | (DIN 11023) 325-18x60 | 15,9 | 56,0 | 59,1 | 18,2 |
| | 325-10x60 | 8,9 | 50,0 | 58,4 | 6,8 |
| | 325-10x50 | 8,9 | 51,2 | 48,8 | 5,4 |
| | 325-8x60 | 7,8 | 48,1 | 58,0 | 4,6 |
| | 325-8x50 | 7,8 | 48,7 | 49,7 | 3,9 |
| | 325-8x45 | 7,8 | 45,0 | 44,8 | 3,6 |
| | 325-8x40 | 7,6 | 44,0 | 44,7 | 3,3 |
| | 325-6x45 | 6,0 | 47,3 | 45,0 | 2,6 |
| | 325-6x32 | 5,8 | 29,2 | 31,4 | 1,6 |
| 325-4,5x40 | 4,6 | 43,3 | 48,6 | 2,1 | |
| 310 | Art.-Nr. / item no. | | | | |
|  Federstecker einfach, aus Stahl, verzinkt <i>single spiral pin made from steel, zinc plated</i> | 310-8 | 8,0 | 132,2 | 43,7 | 11,2 |
| | 310-6 | 8,0 | 124,8 | 42,4 | 5,9 |
| | 310-5 | 5,0 | 102,2 | 35,3 | 3,2 |
| | 310-4 | 4,0 | 75,0 | 27,5 | 1,5 |
| | 310-3 | 3,0 | 72,5 | 23,7 | 0,7 |
| | 310-2 | 2,0 | 60,7 | 13,0 | 0,3 |
| 320 | Art.-Nr. / item no. | | | | |
|  Federstecker doppelt, aus Stahl, verzinkt <i>double spiral pin made from steel, zinc plated</i> | 320-8 | 8,0 | 154,2 | 45,5 | 17,5 |
| | 320-6 | 6,0 | 140,2 | 40,6 | 8,8 |
| | 320-5 | 4,8 | 112,5 | 37,0 | 5,0 |
| | 320-4 | 4,1 | 84,0 | 33,1 | 3,0 |
| | 320-3 | 2,9 | 74,4 | 22,4 | 1,0 |
| 320-2 | 2,0 | 58,0 | 14,7 | 0,5 | |
| 330 | Art.-Nr. / item no. | | | | |
|  Klappsplint aus Stahl, verzinkt <i>folding up pin made from steel, zinc plated</i> | 330-12,0 | 11,8 | 44,9 | 36,0 | 5,2 |
| | 330-11,0 | 10,6 | 42,2 | 37,8 | 4,4 |
| | 330-10,0 | 9,5 | 42,5 | 37,7 | 3,9 |
| | 330-8,0 | 7,8 | 42,0 | 38,0 | 2,8 |
| | 330-8,0 | 5,8 | 42,0 | 37,5 | 1,9 |
| | 330-5,2 | 5,2 | 31,4 | 27,6 | 1,5 |
| 330-4,5 | 4,5 | 42,8 | 30,8 | 1,2 | |

Federstecker aus Edelstahl spiral pins made from stainless steel

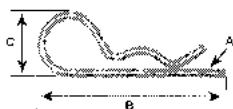

D = Gewicht (kg) bei 100 Stück
weight (kgs) per 100 pieces

Alle Maße in mm
all measurements in mm

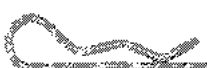
| Art.-Nr. / item no. | Art.-Nr. / item no. | A | B | C | D | |
|--|---|---------|-----|-------|------|------|
| 310-1  | Federstecker einfach aus Edelstahl AISI 316 | 310-1-6 | 6,0 | 118,7 | 41,3 | 6,0 |
| | single spiral pin made from stainless steel AISI 316 | 310-1-5 | 5,0 | 100,4 | 38,5 | 3,8 |
| | | 310-1-4 | 4,0 | 75,7 | 25,8 | 1,5 |
| | | 310-1-3 | 3,0 | 58,8 | 19,3 | 0,1 |
| | | 310-1-2 | 2,0 | 40,4 | 13,9 | 0,05 |

Sonstige Elemente miscellaneous items

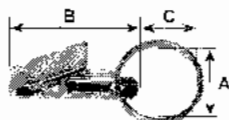



D = Gewicht (kg) bei 100 Stück
weight (kgs) per 100 pieces

Alle Maße in mm
all measurements in mm

| Art.-Nr. / item no. | Art.-Nr. / item no. | A | B | C | D |
|--|--|---------|------|---|-----|
| 514C-NP  | Alligator-Clip aus Stahl, vernickelt | 514C-NP | 35,4 | | 0,5 |
| | alligator-clip made from steel, nickel plated | | | | |

| Art.-Nr. / item no. | Art.-Nr. / item no. | A | B | C | D | |
|---|---|----------|------|------|------|-----|
| 514CK-NP  | Alligator-Clip mit Schlüsselring, aus Stahl, vernickelt | 514CK-NP | 20,5 | 35,4 | 18,0 | 0,5 |
| | alligator-clip with key ring, made from steel, nickel plated | | | | | |

| Art.-Nr. / item no. | Art.-Nr. / item no. | A | B | C | D |
|---|--|----------|---|---|-----|
| 8500-5mm  | Heizungsentlüftungsschlüssel aus Stahl, blank | 8500-5mm | | | 0,5 |
| | radiator key made from steel, self unlocked | | | | |

| Art.-Nr. / item no. | Art.-Nr. / item no. | A | B | C | D |
|---|--|----------|---|---|-----|
| 8600-8mm  | Winkeldorn (Vierkant) aus Stahl, verzinkt | 8600-8mm | | | 4,0 |
| | angle key (square) made from steel, zinc plated | | | | |

Preisliste (EH) Metallwarensortiment

Ausgabe: 08/2010

Die angegebenen Preise bleiben freibleibend. Sie dienen zunächst nur als Orientierung, da durch den sich stark verändernden Rohstoffmarkt alle Metalle starken Preisschwankungen ausgesetzt sind. Unsere Vorlieferanten geben uns zurzeit nur Tagespreise an. Das bedeutet gegebenenfalls starke Preissteigerungen, aber auch Preissenkungen für einzelne Artikel.

Die aktuellen Preise können Sie gern vor Auftragserteilung bei uns abfragen.

Preisliste (EH)

- 1 -

| Seite/page 1 | | |
|------------------|--------|------------|
| Art.-Nr. | €/Stck | €/100 Stck |
| M0148-Z-3/4-NP | 0,72 | 53,73 |
| M0169-Z-5/8-NP | 1,69 | 126,09 |
| M0169-Z-5/8-BP | 1,73 | 129,60 |
| M017-AZ-1-NP | 1,63 | 121,68 |
| M017-AZ-1-BP | 1,72 | 128,22 |
| M017-HM-1 1/4-NP | 2,47 | 184,11 |
| M017-HZ-1-NP | 3,71 | 277,68 |
| M017-Z-1-NP | 1,85 | 138,12 |
| M017-Z-3/4-NP | 1,81 | 135,39 |
| M0170-Z-3/4-NP | 1,59 | 118,95 |
| M0170-Z-5/8-NP | 1,65 | 123,30 |
| M0171-Z-3/4-NP | 1,21 | 90,72 |
| M0171-Z-5/8-NP | 1,20 | 89,55 |

| Seite/page 2 | | |
|------------------|--------|------------|
| Art.-Nr. | €/Stck | €/100 Stck |
| M125-Z-3/4-NP | 1,92 | 143,40 |
| M125-Z-5/8-NP | 1,92 | 143,40 |
| M163-Z-NP | 2,77 | 207,60 |
| M162-Z-NP | 1,91 | 142,89 |
| M161-Z-NP | 2,03 | 151,44 |
| M161-Z-CP | 1,85 | 138,90 |
| M182-Z-1-NP | 1,00 | 74,01 |
| M181-Z-1-NP | 0,75 | 55,35 |
| M205-Z-1/4-NP | 0,51 | 37,65 |
| M205-Z-1/4-BP | 0,75 | 55,80 |
| M225-AZ-3/4-NP | 2,07 | 154,20 |
| M225-HZ-1 1/4-NP | 2,83 | 211,02 |
| M225-HZ-1-NP | 3,12 | 233,10 |
| M225-HZ-5/8-NP | 2,88 | 215,55 |
| M225-HZ-1-BP | 2,88 | 215,55 |
| M225-Z-1-NP | 1,43 | 106,50 |
| M225-Z-7/8-NP | 1,36 | 101,31 |
| M225-Z-3/4-NP | 1,93 | 144,15 |
| M225-Z-5/8-NP | 1,73 | 129,09 |
| M225-1/2-NP | 1,75 | 130,17 |
| M225-Z-3/4-BP | 4,49 | 336,48 |
| M225-Z-5/8-BP | 4,04 | 302,73 |
| M225-Z-3/4-CP | 2,51 | 187,20 |
| M225-Z-5/8-CP | 2,51 | 187,20 |
| M231-M-3/8-SC | 1,53 | 114,15 |
| M230-M-1/4-ZP | 1,32 | 99,00 |

| Seite/page 3 | | |
|-----------------|--------|------------|
| Art.-Nr. | €/Stck | €/100 Stck |
| M47-Z-SQ-3/4-NP | 1,36 | 101,85 |
| M4901-Z-1-NP | 0,76 | 56,64 |
| M4901-Z-3/4-NP | 0,76 | 56,64 |
| M5025-Z-3/4-NP | 1,41 | 105,78 |
| M5025-Z-5/8-NP | 1,05 | 78,84 |
| M5025-Z-1/2-NP | 1,69 | 126,09 |
| M5025-Z-3/8-NP | 1,43 | 106,50 |
| M5025-Z-3/4-BP | 1,69 | 126,63 |
| M5025-Z-5/8-BP | 1,80 | 134,70 |
| M5025-Z-1/2-BP | 1,71 | 127,50 |

| | | |
|----------------|------|--------|
| M5025-Z-3/4-CP | 2,25 | 168,75 |
| M5025-Z-5/8-CP | 1,81 | 135,90 |
| M5025-Z-1/2-CP | 1,81 | 135,90 |
| M5045-Z-1/2-NP | 1,33 | 99,60 |
| M5045-Z-3/8-NP | 1,13 | 84,15 |
| M505-RZ-1-NP | 2,31 | 172,65 |
| M5055-Z-1/2-NP | 0,92 | 69,00 |
| M5055-Z-3/8-NP | 0,83 | 61,50 |
| M5055-Z-1/2-CP | 1,12 | 83,40 |
| M5055-Z-1/2-BP | 0,55 | 40,05 |
| M53-AZ-3/4-CP | 2,28 | 170,76 |
| M53-Z-3/4-NP | 2,15 | 160,29 |

| Seite/page 4 | | |
|-----------------|--------|------------|
| Art.-Nr. | €/Stck | €/100 Stck |
| M5579-Z-1/2-NP | 0,65 | 48,12 |
| M5579-Z-3/8-NP | 0,68 | 50,10 |
| M5579-Z-3/8-BP | 0,72 | 53,70 |
| M5579-Z-3/8-CP | 0,67 | 49,35 |
| M57-Z-3/4-NP | 2,28 | 170,13 |
| M57-Z-5/8-NP | 1,99 | 148,20 |
| M57-Z-3/4-CP | 2,44 | 182,85 |
| M58-Z-1-NP | 2,09 | 156,45 |
| M58-Z-3/4-NP | 1,52 | 113,70 |
| M59-AZ-3/4-NP | 2,40 | 179,28 |
| M59-AZ-5/8-NP | 2,03 | 151,08 |
| M59-AZ-3/4-CP | 1,97 | 147,45 |
| M59-AZ-5/8-CP | 2,95 | 220,20 |
| M59-SAZ-3/4-NP | 2,33 | 174,93 |
| M60-AZ-1-NP | 2,16 | 162,00 |
| M60-AZ-7/8-NP | 2,08 | 155,37 |
| M61-AZ-3/4-NP | 2,07 | 154,41 |
| M7112-K-75mm-NP | 1,71 | 127,65 |
| M7112-K-24mm-NP | 1,71 | 127,65 |

| Seite/page 5 | | |
|----------------------|--------|------------|
| Art.-Nr. | €/Stck | €/100 Stck |
| M7113-K-65mm-NP | 1,35 | 100,80 |
| M7113-K-24mm-NP | 1,35 | 100,80 |
| M7114-K-55mm-NP | 0,84 | 62,85 |
| M7114-K-24mm-NP | 0,84 | 62,85 |
| M801-Z-3/8-NP | 0,24 | 17,70 |
| M D650-AZ-R-3/4-NP | 2,01 | 150,90 |
| M D650-AZ-R-5/8-NP | 1,93 | 144,90 |
| M D650-AZ-R-1/2-NP | 1,72 | 128,55 |
| M D650-Z-R-3/4-NP | 1,85 | 138,06 |
| M D650-Z-R-5/8-NP | 2,05 | 153,84 |
| M D650-Z-R-1/2-NP | 1,53 | 114,75 |
| M D650-Z-6-SQ-3/4-NP | 2,27 | 169,29 |
| M D650-Z-6-SQ-5/8-NP | 2,05 | 153,84 |

#WERT! = Preis auf Anfrage

Alle Preise zzgl. MwSt.

| Seite/page 6 | | |
|-----------------|--------|------------|
| Art.-Nr. | €/Stck | €/100 Stck |
| M100-Z-1-NP | 2,11 | 157,32 |
| M100-Z-7/8-NP | 2,03 | 151,35 |
| M100-Z-1-BP | 2,09 | 156,57 |
| M1001-Z-1/2-NP | 4,52 | 338,28 |
| M1001-Z-1/2-BP | 4,95 | 370,65 |
| M1002-Z-SQ-1-NP | 4,03 | 301,20 |
| M1002-Z-R-1-NP | 4,79 | 358,71 |
| M1011-Z-5/8-NP | 3,72 | 279,00 |
| M105-Z-3/4-NP | 1,60 | 119,85 |
| M200-Z-1-NP | 1,65 | 123,48 |
| M200-Z-3/4-NP | 1,96 | 146,82 |
| M201-Z-1-NP | #WERT! | #WERT! |
| M202-TG-3/4-NP | 2,36 | 176,10 |

| Seite/page 7 | | |
|------------------|--------|------------|
| Art.-Nr. | €/Stck | €/100 Stck |
| M222-Z-3/4-NP | 1,99 | 148,20 |
| M222-Z-5/8-NP | 1,99 | 148,20 |
| M241-ZT-9/16-NP | 0,73 | 54,78 |
| M242-ZS-1-NP | 0,44 | 32,16 |
| M242-ZS-3/4-NP | 0,32 | 23,04 |
| M242-ZS-5/8-NP | 0,36 | 27,00 |
| M300-Z-3/4-NP | 1,72 | 128,73 |
| M3142-M-R-7/8-NP | 4,56 | 341,76 |
| M3142-M-SQ-1-NP | 4,80 | 359,22 |
| M333-M-1 1/8-NP | 5,65 | 423,06 |
| M340-Z-1-NP | 0,61 | 45,33 |
| M340-Z-3/4-NP | 0,97 | 72,45 |
| M340-Z-5/8-NP | 0,80 | 59,01 |

| Seite/page 8 | | |
|----------------|--------|------------|
| Art.-Nr. | €/Stck | €/100 Stck |
| M341-Z-3/8-NP | 0,64 | 47,52 |
| M4218-Z-3/4-NP | 1,91 | 142,41 |
| M4218-Z-5/8-NP | 1,99 | 148,20 |
| M437-Z-3/4-NP | 1,29 | 96,93 |
| M437-Z-3/8-NP | 1,01 | 75,30 |
| M5013-Z-3/4-NP | 2,28 | 170,49 |
| M5013-Z-5/8-NP | 2,05 | 153,96 |
| M5013-Z-1/2-NP | 1,59 | 118,38 |
| M5013-Z-3/8-NP | 1,33 | 99,48 |
| M5015-Z-1-NP | 1,92 | 143,85 |
| M5015-Z-3/4-NP | 1,88 | 140,73 |
| M5015-Z-5/8-NP | 1,73 | 129,57 |
| M5016-Z-1-NP | #WERT! | #WERT! |
| M5016-Z-3/4-NP | 2,29 | 171,90 |
| M5017-Z-1-NP | 3,23 | 241,89 |

| Seite/page 9 | | |
|-----------------|--------|------------|
| Art.-Nr. | €/Stck | €/100 Stck |
| M5037-Z-3/8-NP | 1,08 | 80,25 |
| M577-Z-3/8-NP | 0,48 | 35,19 |
| M578-Z-1/4-NP | 0,41 | 30,18 |
| M579-Z-1/4-NP | 0,37 | 27,90 |
| M830-Z-3/4-NP | 1,88 | 140,40 |
| M9001-Z-1-NP | 1,93 | 144,06 |
| M D250-Z-1-NP | 1,32 | 98,94 |
| M D250-Z-3/4-NP | 1,33 | 99,30 |
| M D250-Z-5/8-NP | 0,43 | 31,32 |

| Seite/page 10 | | |
|-----------------|--------|------------|
| Art.-Nr. | €/Stck | €/100 Stck |
| M115D-5/8-ZP | 0,60 | 44,40 |
| M155-120mm-ZP | 2,71 | 202,95 |
| M155-100mm-ZP | 2,36 | 176,40 |
| M155-90mm-ZP | 1,60 | 119,85 |
| M155-80mm-ZP | 1,03 | 76,80 |
| M155-70mm-ZP | 0,85 | 63,75 |
| M155-60mm-ZP | 0,56 | 42,00 |
| M155-50mm-ZP | 0,47 | 34,80 |
| M226-80x8-ZP | 1,47 | 109,44 |
| M226-70x7-ZP | #WERT! | #WERT! |
| M226-60x6-ZP | 1,51 | 112,35 |
| M226-S-80x8-ZP | #WERT! | #WERT! |
| M226-S-70x7-ZP | #WERT! | #WERT! |
| M226-S-60x6-ZP | #WERT! | #WERT! |
| M2311-V-92mm-ZP | 2,60 | 194,40 |
| M245-200x15-ZP | 5,07 | 379,95 |
| M245-180x14-ZP | 3,41 | 255,90 |
| M245-160x13-ZP | 3,15 | 235,80 |
| M245-140x12-ZP | 2,48 | 185,25 |
| M245-120x11-ZP | 1,55 | 115,83 |
| M245-100x10-ZP | 1,24 | 93,00 |
| M245-90x9-ZP | 1,03 | 76,68 |
| M245-80x8-ZP | 0,79 | 58,92 |
| M245-70x7-ZP | 0,73 | 54,36 |
| M245-60x6-ZP | 0,51 | 37,65 |
| M245-50x5-ZP | 0,39 | 28,23 |
| M245-40x4-ZP | 0,49 | 36,18 |

| Seite/page 11 | | |
|---------------|--------|------------|
| Art.-Nr. | €/Stck | €/100 Stck |
| M245-K-120x11 | 1,56 | 116,40 |
| M245-K-100x10 | 1,11 | 82,65 |
| M245-K-80x8 | 0,59 | 43,80 |
| M245-K-60x6 | 0,52 | 38,01 |
| M245-K-50x5 | 0,31 | 22,05 |
| M245-S-180x14 | 4,88 | 365,55 |
| M245-S-160x13 | 3,05 | 228,30 |
| M245-S-140x12 | 2,23 | 166,35 |
| M245-S-120x11 | 1,57 | 117,15 |
| M245-S-100x10 | 1,71 | 127,62 |
| M245-S-80x8 | 1,04 | 77,52 |
| M245-S-70x7 | 0,80 | 59,88 |
| M245-S-60x6 | 0,61 | 45,60 |
| M245-S-50x5 | 0,31 | 22,35 |

#WERT! = Preis auf Anfrage

Alle Preise zzgl. MwSt.

| | | |
|-----------------|------|-------|
| M246-100x10-ZP | 0,92 | 68,85 |
| M246-80x8-ZP | 1,11 | 82,05 |
| M246-70x7-ZP | 0,45 | 33,45 |
| M246-60x6-ZP | 0,32 | 23,70 |
| M5001-1/2-70-NP | 0,67 | 49,20 |
| M5001-1/2-60-NP | 0,57 | 42,30 |
| M5001-1/2-50-NP | 0,53 | 39,45 |
| M5001-1/2-40-NP | 0,48 | 35,25 |
| M5001-70/16-NP | 0,68 | 50,55 |
| M5001-60/16-NP | 0,57 | 42,30 |
| M5001-50/12-NP | 0,53 | 39,45 |
| M5001-40/12-NP | 0,48 | 35,25 |
| M5002-70/14-NP | 0,67 | 49,20 |
| M5002-60/14-NP | 0,87 | 64,50 |
| M5002-50/14-NP | 0,53 | 39,45 |
| M5002-40/12-NP | 0,84 | 62,25 |
| M5003-70/24-NP | 0,67 | 49,20 |
| M5003-60/20-NP | 0,81 | 60,30 |
| M5003-50/20-NP | 0,72 | 54,00 |
| M5003-40/16-NP | 0,45 | 33,78 |

Seite/page 12

| Art.-Nr. | €/Stck | €/100 Stck |
|----------------|--------|------------|
| M5287-100-NP | 1,09 | 81,30 |
| M5287-80-NP | 0,72 | 53,52 |
| M5287-60-NP | 0,31 | 22,59 |
| M5287-50-NP | 0,20 | 14,52 |
| M5287-45-NP | 0,20 | 14,76 |
| M5287-40-NP | 0,11 | 7,61 |
| M5287-35-NP | 0,13 | 9,93 |
| M5287-30-NP | 0,07 | 4,50 |
| M5287-25-NP | 0,04 | 2,89 |
| M5287-T-60-ZP | 0,25 | 18,30 |
| M5287-W-100-NP | 0,84 | 62,25 |
| M5287-W-80-NP | 0,79 | 58,35 |
| M5287-W-60-NP | 0,33 | 24,15 |
| M5287-W-50-NP | 0,21 | 15,45 |
| M5287-W-45-NP | 0,20 | 14,10 |
| M5287-W-40-NP | 0,27 | 19,05 |
| M5287-W-35-NP | 0,13 | 9,60 |
| M5287-W-30-NP | 0,11 | 7,65 |
| M689-2500-SC | 32,04 | 2403,00 |
| M689-1600-SC | 23,33 | 1749,90 |
| M689-1000-SC | 15,80 | 1185,00 |
| M689-500-SC | 7,60 | 570,00 |
| M689-250-SC | 5,35 | 400,95 |
| M689-S-2500-SC | 55,72 | 4178,25 |
| M689-S-1600-SC | 38,08 | 2855,25 |
| M689-S-1000-SC | 29,44 | 2207,85 |
| M689-S-500-SC | 19,87 | 1489,80 |
| M689-S-250-SC | 16,39 | 1228,95 |
| M734S-1-NP | 0,21 | 15,48 |
| M734S-3/4-NP | 0,19 | 13,35 |
| M734S-5/8-NP | 0,21 | 15,33 |

Seite/page 13

| Art.-Nr. | €/Stck | €/100 Stck |
|-------------------|--------|------------|
| M734T-3/8-NP | 0,15 | 10,35 |
| M FAD 155-17,5-NP | 0,07 | 4,13 |
| M FAD 153-13,5-NP | 0,05 | 3,56 |

Seite/page 14

| Art.-Nr. | €/Stck | €/100 Stck |
|-------------------|--------|------------|
| M017-B-1-SC | 6,03 | 451,86 |
| M017-B-3/4-SC | 5,44 | 407,85 |
| M017-B-5/8-SC | 6,33 | 474,21 |
| M0170-B-3/4-SC | 3,63 | 271,05 |
| M0170-B-5/8-SC | 3,44 | 257,31 |
| M100-B-3/4-SC | 7,44 | 558,00 |
| M162-B-102mm-SC | 3,75 | 280,20 |
| M161-B-91mm-SC | 2,57 | 192,60 |
| M2002-B-R-1-SC | 6,24 | 467,40 |
| M2002-B-R-3/4-SC | 9,24 | 692,10 |
| M2002-B-SQ-1-SC | 6,24 | 467,40 |
| M2002-B-SQ-3/4-SC | 7,05 | 528,60 |
| M225-B-1-SC | 5,24 | 392,13 |
| M225-B-3/4-SC | 4,53 | 339,75 |
| M225-B-5/8-SC | 4,04 | 302,73 |
| M225-HB-1 1/8-SC | 9,64 | 722,01 |
| M225-HB-7/8-SC | 5,48 | 410,55 |

Seite/page 15

| Art.-Nr. | €/Stck | €/100 Stck |
|------------------|--------|------------|
| M249-B-3/4-SC | 4,04 | 302,25 |
| M249-B-5/8-SC | 1,56 | 116,19 |
| M249-B-3/8-SC | 1,49 | 111,63 |
| M249-B-3/4-NP | 4,17 | 312,75 |
| M249-B-5/8-NP | 3,00 | 225,00 |
| M249-B-3/8-NP | 2,25 | 168,75 |
| M251-B-3/4-SC | 4,81 | 360,90 |
| M251-B-5/8-SC | 4,88 | 365,70 |
| M3002-B-R-1-SC | 18,43 | 1381,74 |
| M3002-B-R-3/4-SC | #WERT! | #WERT! |
| M340-B-3/4-SC | 2,12 | 158,91 |
| M340-B-5/8-SC | 1,93 | 144,42 |
| M340-B-1/2-SC | 1,41 | 105,60 |
| M3726-B-1-SC | 3,71 | 277,71 |
| M3726-B-3/4-SC | 3,55 | 265,08 |
| M3726-B-5/8-SC | 3,27 | 244,62 |
| M3726-B-1-NP | 3,89 | 291,21 |
| M3726-B-3/4-NP | 3,76 | 281,10 |
| M3726-B-5/8-NP | 3,77 | 282,33 |
| M4979-B-3/4-SC | 4,93 | 369,54 |
| M5013-B-5/8-SC | 5,96 | 446,79 |
| M5013-B-1/2-SC | 5,44 | 407,97 |
| M5015-B-3/4-SC | 6,11 | 457,47 |
| M5015-B-5/8-SC | 6,03 | 451,53 |

#WERT! = Preis auf Anfrage

Alle Preise zzgl. MwSt.

| Seite/page 16 | | |
|----------------|--------|------------|
| Art.-Nr. | €/Stck | €/100 Stck |
| M5025-B-3/4-SC | 4,51 | 337,11 |
| M5025-B-5/8-SC | 3,85 | 288,99 |
| M5025-B-1/2-SC | 3,44 | 257,73 |
| M5025-B-3/8-SC | 2,53 | 189,90 |
| M5579-B-3/8-SC | 1,85 | 138,72 |

| Seite/page 17 | | |
|----------------|--------|------------|
| Art.-Nr. | €/Stck | €/100 Stck |
| M163-I-4 3/4 | 13,29 | 996,30 |
| M163-I-4 3/16 | 10,89 | 816,72 |
| M225-I-1 1/4 | 11,11 | 832,86 |
| M225-I-1 1/8 | 10,15 | 760,77 |
| M225-I-3/4 | 8,16 | 611,43 |
| M225-I-5/8 | 9,40 | 704,55 |
| M225-I-1/2 | 5,91 | 442,95 |
| M2315-I-100mm | 12,20 | 915,00 |
| M2315-I-70mm | 4,43 | 331,83 |
| M2315-I-50mm | 2,21 | 165,93 |
| M245-I-160x13 | 16,53 | 1239,30 |
| M245-I-140x12 | 13,68 | 1026,00 |
| M245-I-120x11 | 9,45 | 708,90 |
| M245-I-100x10 | 6,17 | 462,45 |
| M245-I-80x8 | 5,40 | 404,73 |
| M245-I-70x7 | 3,07 | 229,11 |
| M245-I-60x6 | 2,44 | 182,13 |
| M245-I-50x5 | 1,97 | 147,18 |
| M245-I-40x4 | 1,75 | 130,29 |
| M245-IK-120x11 | 10,71 | 802,35 |
| M245-IK-100x10 | 7,00 | 524,85 |
| M245-IK-80x8 | 5,40 | 404,73 |
| M245-IK-70x7 | 3,13 | 234,30 |
| M245-IK-60x6 | 2,15 | 160,35 |
| M245-IK-50x5 | 1,81 | 135,45 |
| M245-IS-120x11 | 11,83 | 886,50 |
| M245-IS-100x10 | 7,69 | 576,54 |
| M245-IS-80x8 | 4,87 | 364,95 |
| M245-IS-60x6 | 4,56 | 342,00 |
| M251-I-3-117 | 22,27 | 1669,35 |
| M251-I-2-98 | 12,37 | 927,63 |

| Seite/page 18 | | |
|---------------|--------|------------|
| Art.-Nr. | €/Stck | €/100 Stck |
| M4979-I-3/4 | 12,71 | 952,62 |
| M5025-I-1/2 | 7,01 | 525,93 |
| M5287-I-50mm | 1,03 | 76,20 |
| M5287-I-40mm | 0,81 | 60,90 |
| M SKH-I-70x3 | 1,69 | 126,30 |
| M SKH-60x3 | 1,57 | 117,15 |
| M SKH-50x3 | 1,84 | 137,82 |

| Seite/page 19 | | |
|--------------------|--------|------------|
| Art.-Nr. | €/Stck | €/100 Stck |
| M229-7/8 | 18,68 | 1401,00 |
| M229F | #WERT! | #WERT! |
| M2490-80x8 | 0,84 | 62,85 |
| M2490-60x6 | 0,67 | 49,26 |
| M2490-50x5 | 0,41 | 30,90 |
| M2490-AL-80x8/21mm | 0,88 | 65,10 |
| M72-S-2200 KP | #WERT! | #WERT! |
| M72-S-24 KN | 30,40 | 2280,00 |

| Seite/page 20 | | |
|---------------|--------|------------|
| Art.-Nr. | €/Stck | €/100 Stck |
| M A2-40mm | 0,28 | 20,19 |
| M A2-30mm | 0,27 | 19,77 |
| M A2-25mm | 0,29 | 21,78 |
| M A2-20mm | 0,29 | 21,81 |
| M A6-8mm | 1,07 | 79,47 |
| M A6-5mm | 0,60 | 45,00 |

| Seite/page 21 | | |
|-------------------|--------|------------|
| Art.-Nr. | €/Stck | €/100 Stck |
| M0392-7/8x1-NP | 0,12 | 8,76 |
| M0392-7/8x1-BP | 0,16 | 11,70 |
| M10-7x120-ZP | 3,15 | 235,35 |
| M256-50x40x7-NP | 0,80 | 59,52 |
| M256-45x35x6,5-NP | 0,51 | 37,05 |
| M256-40x30x5-NP | 0,33 | 24,45 |
| M256-35x25x5-NP | 0,31 | 22,95 |
| M256-30x20x3,8-NP | 0,15 | 10,20 |
| M256-27x20x3,5-NP | 0,15 | 10,80 |
| M256-25x22x4-NP | 0,16 | 11,40 |
| M256-25x18x3,4-NP | 0,12 | 8,55 |
| M256-25x18x3-NP | 0,11 | 7,65 |
| M256-22x16x3,2-NP | 0,11 | 7,80 |
| M256-20x15x3-NP | 0,11 | 7,50 |
| M256-18x14x2,8-NP | 0,11 | 7,13 |
| M256-16x12x2,6-NP | 0,09 | 6,38 |
| M256-14x10x2,4-NP | 0,08 | 5,06 |
| M256-12x10x2,2-NP | 0,05 | 3,38 |
| M256-10x8x2,1-NP | 0,04 | 2,63 |
| M256-35x25x5-ZP | #WERT! | #WERT! |
| M256-30x20x3,8-BP | #WERT! | #WERT! |
| M256-27x20x3,5-BP | #WERT! | #WERT! |
| M256-25x18x3,4-BP | #WERT! | #WERT! |
| M256-22x16x3,2-BP | #WERT! | #WERT! |
| M256-20x15x3-BP | #WERT! | #WERT! |
| M256-18x14x2,8-BP | #WERT! | #WERT! |
| M256-16x12x2,6-BP | #WERT! | #WERT! |
| M256-14x10x2,4-BP | #WERT! | #WERT! |
| M256-12x10x2,2-BP | #WERT! | #WERT! |
| M256-10x8x2,1-BP | #WERT! | #WERT! |
| M256-25x18x3,4-BP | 0,16 | 11,70 |
| M256-20x15x3-BP | 0,12 | 8,70 |
| M258-80x12-ZP | 3,48 | 260,61 |
| M258-80x8-ZP | 5,00 | 375,00 |
| M258-70x8-ZP | 1,44 | 107,37 |
| M258-60x12-ZP | 1,44 | 108,00 |

#WERT! = Preis auf Anfrage

Alle Preise zzgl. MwSt.

Preisliste (EH)

- 5 -

| | | |
|---------------|--------|--------|
| M258-60x9-ZP | 2,12 | 158,40 |
| M258-60x8-ZP | 1,00 | 74,49 |
| M258-60x6-ZP | 0,56 | 41,16 |
| M258-50x12-ZP | #WERT! | #WERT! |
| M258-50x10-ZP | 1,76 | 131,55 |
| M258-50x7-ZP | 0,68 | 50,76 |
| M258-50x6-ZP | 0,57 | 42,60 |
| M258-50x5-ZP | 0,41 | 30,78 |
| M258-45x10-ZP | #WERT! | #WERT! |
| M258-45x9-ZP | 0,00 | 0,00 |
| M258-45x8-ZP | 0,72 | 53,07 |
| M258-40x10-ZP | 2,75 | 205,17 |
| M258-40x9-ZP | 1,20 | 89,13 |

Seite/page 22

| Art.-Nr. | €/Stck | €/100 Stck |
|----------------|--------|------------|
| M258-40x8-NP | 0,00 | 0,00 |
| M258-40x6-NP | 0,43 | 31,86 |
| M258-40x5-NP | 0,33 | 24,81 |
| M258-40x4-NP | 0,23 | 16,05 |
| M258-36x5-NP | 0,28 | 20,34 |
| M258-35x7-NP | 0,21 | 15,84 |
| M258-32x4-NP | 0,17 | 12,75 |
| M258-31x4,5-NP | 0,24 | 17,01 |
| M258-30x4-NP | 0,21 | 15,21 |
| M258-27x3,7-NP | 0,13 | 9,93 |
| M258-25x4-NP | 0,17 | 12,54 |
| M258-25x3,5-NP | 0,12 | 8,46 |
| M258-25x3-NP | 0,12 | 8,93 |
| M258-22x3,2-NP | 0,11 | 7,59 |
| M258-21x3-NP | #WERT! | #WERT! |
| M258-20x3-NP | 0,12 | 8,85 |
| M258-18x2,8-NP | 0,09 | 6,90 |
| M258-16x2,8-NP | #WERT! | #WERT! |
| M258-16x2,5-NP | 0,09 | 6,75 |
| M258-14x2,4-NP | 0,12 | 8,18 |
| M258-12x2,2-NP | 0,05 | 3,79 |
| M258-40x6-BP | 0,45 | 33,75 |
| M258-40x5-BP | #WERT! | #WERT! |
| M258-40x4-BP | #WERT! | #WERT! |
| M258-32x4-BP | 0,20 | 15,00 |
| M258-31x4,5-BP | 0,00 | 0,00 |
| M258-30x4-BP | 0,17 | 12,99 |
| M258-27x3,7-BP | #WERT! | #WERT! |
| M258-25x3,5-BP | 0,20 | 14,01 |
| M258-22x3,2-BP | 0,19 | 13,50 |
| M258-20x3-BP | 0,13 | 9,30 |
| M258-40x6-CP | #WERT! | #WERT! |
| M258-31x4,5-CP | #WERT! | #WERT! |
| M258-25x4-CP | 0,24 | 17,25 |
| M258-22x3,2-CP | #WERT! | #WERT! |
| M258-18x2,8-CP | 0,15 | 10,95 |
| M258-16x2,8-CP | #WERT! | #WERT! |
| M258-14x2,4-CP | #WERT! | #WERT! |
| M258-40x5-CP | #WERT! | #WERT! |

| | | |
|---------------------|------|-------|
| M259-50-NP | 0,41 | 30,30 |
| M259-38-NP | 0,12 | 8,52 |
| M259-35-NP | 0,16 | 11,22 |
| M259-30-NP | 0,17 | 12,12 |
| M259-28-NP | 0,15 | 10,50 |
| M259-26-NP | 0,13 | 9,87 |
| M259-24-NP | 0,12 | 8,10 |
| M259-20-NP | 0,09 | 6,45 |
| M259-18-NP | 0,07 | 4,43 |
| M259-16-NP | 0,07 | 4,54 |
| M259-14-NP | 0,05 | 3,41 |
| M259-12-NP | 0,07 | 4,09 |
| M259-10-NP | 0,05 | 3,38 |
| M340-6x30-ZP | 1,24 | 92,82 |
| M3610-ST-1x1 1/2-NP | 1,19 | 88,68 |
| M3610-ST-1x1 1/2-BP | 0,96 | 71,76 |

Seite/page 23

| Art.-Nr. | €/Stck | €/100 Stck |
|--------------------|--------|------------|
| M943128-120-NP | 1,60 | 119,28 |
| M943128-90-NP | 1,75 | 130,05 |
| M943128-120A-NP | 1,48 | 110,25 |
| M943128-90A-NP | 1,39 | 103,80 |
| M3610-B-1x1 1/2-SC | 3,97 | 297,57 |
| M452-B-1 1/2-SC | 3,21 | 240,06 |
| M452-B-1 1/4-SC | 1,31 | 97,08 |
| M452-B-1 1/8-SC | 1,71 | 127,98 |
| M452-B-1-SC | 1,53 | 114,15 |
| M452-B-7/8-SC | 1,13 | 84,42 |
| M452-B-3/4-SC | 1,07 | 79,65 |
| M452-B-5/8-SC | 0,88 | 65,01 |
| M452-B-1 1/2-NP | 3,68 | 275,43 |
| M452-B-1 1/4-NP | 1,61 | 120,27 |
| M452-B-1 1/8-NP | 2,19 | 163,29 |
| M452-B-1-NP | 1,87 | 139,44 |
| M452-B-7/8-NP | 1,51 | 112,53 |
| M452-B-3/4-NP | 1,03 | 76,23 |
| M452-B-5/8-NP | 0,95 | 70,86 |
| M7-B-2-SC | 4,65 | 348,78 |
| M7-B-1 3/4-SC | 2,83 | 211,83 |
| M7-B-1 1/2-SC | 2,97 | 222,84 |
| M7-B-1 1/4-SC | 2,44 | 182,16 |
| M7-B-1 1/8-SC | 1,59 | 118,80 |
| M7-B-1-SC | 1,63 | 121,29 |
| M7-B-7/8-SC | 1,23 | 91,80 |
| M7-B-3/4-SC | 1,08 | 80,22 |
| M7-B-5/8-SC | 0,89 | 66,09 |
| M7-B-1/2-SC | 0,69 | 51,54 |
| M7-B-2-NP | 3,72 | 279,00 |
| M7-B-1 3/4-NP | 3,07 | 229,56 |
| M7-B-1 1/2-NP | 2,80 | 209,52 |
| M7-B-1 1/4-NP | 2,23 | 166,29 |
| M7-B-1 1/8-NP | 1,91 | 142,89 |

#WERT! = Preis auf Anfrage

Alle Preise zzgl. MwSt.

| | | |
|-------------|------|--------|
| M7-B-1-NP | 1,81 | 135,48 |
| M7-B-7/8-NP | 1,15 | 85,80 |
| M7-B-3/4-NP | 0,95 | 70,35 |
| M7-B-5/8-NP | 1,03 | 76,17 |
| M7-B-1/2-NP | 0,63 | 46,92 |

Seite/page 24

| Art.-Nr. | €/Stck | €/100 Stck |
|-------------|--------|------------|
| M256-I-50x8 | 4,64 | 347,49 |
| M256-I-50x6 | 2,71 | 202,83 |
| M256-I-40x4 | 1,17 | 87,18 |
| M256-I-36x5 | 2,39 | 178,95 |
| M256-I-30x4 | 1,01 | 75,66 |
| M256-I-25x4 | 0,95 | 70,32 |
| M256-I-20x4 | 0,79 | 58,11 |
| M256-I-20x3 | 0,67 | 49,29 |
| M7-I-70x8 | 4,77 | 357,60 |
| M7-I-60x5 | 1,99 | 148,26 |
| M7-I-50x8 | 4,65 | 348,57 |
| M7-I-50x6 | 2,65 | 198,06 |
| M7-I-45x8 | 3,80 | 284,49 |
| M7-I-40x6 | 2,01 | 150,60 |
| M7-I-40x5 | 1,45 | 108,81 |
| M7-I-40x4 | 1,24 | 92,91 |
| M7-I-35x4 | 1,12 | 83,52 |
| M7-I-30x4 | 0,88 | 65,28 |
| M7-I-25x4 | 1,03 | 76,86 |
| M7-I-20x3 | 0,81 | 60,60 |

Seite/page 25

| Art.-Nr. | €/Stck | €/100 Stck |
|------------------|--------|------------|
| M02120-28x18-NP | 0,81 | 60,33 |
| M02120-25x8-NP | 0,60 | 44,79 |
| M02120-20x8-NP | 0,55 | 40,20 |
| M02120-17x6-NP | 0,44 | 32,10 |
| M02120-15x6-NP | 0,35 | 25,20 |
| M1023-ST-1-NP | 0,49 | 36,33 |
| M1023-ST-3/4-NP | 0,41 | 30,63 |
| M1375+2300-80-NP | 3,49 | 261,84 |
| M1375+2300-50-NP | 1,88 | 140,13 |
| M1375+2300-38-NP | 1,33 | 99,03 |
| M1375+2300-50-BP | 1,89 | 141,09 |
| M1375-ST-2-NP | 1,55 | 115,41 |
| M1375-ST-2-BP | 1,20 | 89,70 |
| M2300-50Hoch-NP | 1,07 | 79,98 |
| M2300-ST-3-NP | 0,51 | 37,20 |
| M2300-ST-2-NP | 0,36 | 27,00 |
| M4690-0,9x20-NP | 0,11 | 7,53 |
| M4691-1,8x25-NP | 0,25 | 18,69 |

Seite/page 26

| Art.-Nr. | €/Stck | €/100 Stck |
|-------------------|--------|------------|
| M1049-ST-25x15-NP | 0,16 | 12,00 |
| M1407-30W-NP | 0,57 | 42,51 |
| M1407-27W-NP | 0,47 | 34,95 |
| M1407-25W-NP | 0,40 | 29,55 |
| M1407-20W-NP | 0,24 | 17,91 |
| M1407-18W-NP | 0,33 | 24,54 |
| M1407-16W-NP | 0,29 | 21,72 |

| | | |
|---------------|--------|--------|
| M1407-14W-NP | 0,29 | 21,18 |
| M1407-12W-NP | 0,20 | 14,52 |
| M1407-10W-NP | 0,33 | 24,24 |
| M1407-27W-BP | 0,40 | 29,55 |
| M1407-20W-BP | 0,25 | 18,81 |
| M1440-50-NP | 1,60 | 119,37 |
| M1440-40-NP | 1,41 | 105,03 |
| M1440-50-ZP | 1,13 | 84,45 |
| M1440-40-ZP | #WERT! | #WERT! |
| M1440-25-ZP | 0,60 | 45,00 |
| M1230-R-1-NP | 1,87 | 139,92 |
| M147-Z-1-NP | 1,47 | 109,80 |
| M147-Z-3/4-NP | 0,79 | 58,53 |
| M147-Z-5/8-NP | 0,52 | 39,00 |
| M147-Z-1/2-NP | 0,64 | 47,85 |
| M147-Z-1-BP | 0,99 | 73,44 |
| M147-Z-3/4-BP | 0,57 | 42,99 |
| M210-Z-1-NP | 0,76 | 56,88 |
| M210-Z-3/4-NP | 0,47 | 34,83 |
| M210-Z-5/8-NP | 0,33 | 24,63 |
| M210-Z-1/2-NP | 0,47 | 34,50 |
| M260-25x7-NP | 0,60 | 44,58 |
| M260-25x7-BP | 0,64 | 47,91 |

Seite/page 27

| Art.-Nr. | €/Stck | €/100 Stck |
|---------------|--------|------------|
| M270-26x5-NP | 0,84 | 62,61 |
| M270-26x5-BP | 0,51 | 37,89 |
| M370-M-1-NP | 1,99 | 148,47 |
| M370-Z-1-NP | 2,01 | 150,15 |
| M370-M-1-BP | 1,52 | 113,88 |
| M370-Z-1-BP | #WERT! | #WERT! |
| M2800-50-NP | 1,52 | 113,16 |
| M4960-40-NP | 0,37 | 27,90 |
| M4960-20-NP | 0,17 | 12,12 |
| M5-Z-1-NP | 0,76 | 56,07 |
| M5-Z-3/4-NP | 0,93 | 69,03 |
| M5-Z-5/8-NP | 0,59 | 43,20 |
| M5-Z-1/2-NP | 0,41 | 30,60 |
| M5701-25-ZP | 1,77 | 132,90 |
| M5702-25-ZP | 1,07 | 79,80 |
| M5704-20-ZP | 0,88 | 66,00 |
| M5706-HZ-1-NP | 1,60 | 119,37 |
| M5706-HZ-1-BP | 1,63 | 121,50 |

Seite/page 28

| Art.-Nr. | €/Stck | €/100 Stck |
|------------|--------|------------|
| M257-40-NP | 0,16 | 11,37 |
| M257-30-NP | 0,21 | 15,57 |
| M257-25-NP | 0,13 | 9,27 |
| M257-22-NP | 0,12 | 8,97 |
| M257-20-NP | 0,12 | 8,25 |
| M257-18-NP | 0,12 | 8,97 |
| M257-16-NP | 0,11 | 7,74 |
| M257-14-NP | 0,13 | 9,30 |
| M257-12-NP | 0,11 | 7,80 |
| M257-10-NP | 0,16 | 11,40 |

#WERT! = Preis auf Anfrage

Alle Preise zzgl. MwSt.

Preisliste (EH)

- 7 -

| | | |
|-----------------|------|-------|
| M257-25-BP | 0,07 | 4,88 |
| M257-20-BP | 0,19 | 13,05 |
| M257-16-BP | 0,05 | 3,79 |
| M257-12-BP | 0,05 | 3,79 |
| M257-H-30-NP | 0,13 | 9,34 |
| M257-H-25-NP | 0,12 | 8,43 |
| M257-H-20-NP | 0,13 | 9,78 |
| M257-H-18-NP | 0,08 | 5,55 |
| M4950-ST-1-NP | 0,09 | 6,60 |
| M4950-ST-3/4-NP | 0,09 | 6,08 |
| M4950-ST-5/8-NP | 0,05 | 3,23 |
| M4950-W-2-NP | 0,17 | 12,03 |

Seite/page 29

| Art.-Nr. | €/Stck | €/100 Stck |
|---------------|--------|------------|
| M12-B-32-SC | 3,08 | 230,40 |
| M12-B-25-SC | 2,77 | 207,54 |
| M12-B-20-SC | 2,11 | 157,08 |
| M12-B-16-SC | 1,49 | 111,72 |
| M12-B-14-SC | 1,23 | 91,44 |
| M12-B-12-SC | 1,12 | 83,70 |
| M12-B-32-NP | 2,92 | 219,00 |
| M12-B-25-NP | 2,04 | 153,00 |
| M12-B-20-NP | 1,64 | 123,00 |
| M12-B-16-NP | 1,67 | 124,95 |
| M12-B-14-NP | 1,32 | 99,00 |
| M12-B-12-NP | 1,45 | 108,18 |
| M121-B-3/4-SC | 1,32 | 98,88 |
| M121-B-5/8-SC | 0,95 | 70,80 |
| M121-B-1/2-SC | 1,08 | 80,22 |
| M121-B-3/4-NP | 1,64 | 122,61 |
| M121-B-5/8-NP | 1,23 | 91,14 |
| M121-B-1/2-NP | 1,17 | 87,09 |
| M122-B-3/4-SC | 2,24 | 167,64 |
| M122-B-5/8-SC | 1,75 | 130,56 |
| M122-B-3/4-NP | 2,40 | 179,37 |
| M122-B-5/8-NP | 2,20 | 164,49 |
| M123-B-20-SC | 2,35 | 175,56 |
| M123-B-16-SC | 1,52 | 113,43 |
| M123-B-13-SC | 1,17 | 87,87 |
| M123-B-20-NP | 2,00 | 149,91 |
| M123-B-16-NP | 2,01 | 150,57 |
| M123-B-13-NP | 1,27 | 94,53 |
| M124-B-5/8-SC | 0,84 | 63,00 |
| M124-B-5/8-NP | 0,88 | 65,25 |
| M210-B-1-SC | 1,65 | 123,93 |
| M210-B-3/4-SC | 1,15 | 85,92 |
| M210-B-5/8-SC | 1,01 | 75,09 |
| M210-B-1/2-SC | 0,83 | 61,53 |
| M210-B-1-NP | 1,88 | 141,00 |
| M210-B-3/4-NP | 1,27 | 94,38 |
| M210-B-5/8-NP | 1,24 | 92,88 |
| M210-B-1/2-NP | 0,88 | 65,07 |
| M369-B-1-SC | 3,01 | 225,60 |
| M369-B-3/4-SC | 2,41 | 180,39 |
| M369-B-1/2-SC | 0,97 | 72,90 |

| | | |
|---------------|------|--------|
| M369-B-1-NP | 3,99 | 298,83 |
| M369-B-3/4-NP | 1,96 | 146,43 |
| M369-B-1/2-NP | 2,59 | 193,05 |

Seite/page 30

| Art.-Nr. | €/Stck | €/100 Stck |
|------------------|--------|------------|
| M370-B-1-SC | 3,53 | 264,72 |
| M370-B-1-NP | 3,81 | 285,30 |
| M5-B-1-SC | 1,59 | 118,20 |
| M5-B-3/4-SC | 1,20 | 89,40 |
| M5-B-5/8-SC | 1,40 | 104,16 |
| M5-B-1/2-SC | 0,96 | 71,91 |
| M5-B-1-NP | 1,60 | 120,00 |
| M5-B-3/4-NP | 1,77 | 132,06 |
| M5-B-5/8-NP | 1,72 | 128,37 |
| M5-B-1/2-NP | 1,09 | 81,24 |
| M5705-B-1 1/4-SC | 4,07 | 304,20 |
| M5705-B-1 1/8-SC | 3,52 | 264,00 |
| M5705-B-1-SC | 2,81 | 210,09 |
| M5705-B-3/4-SC | 1,83 | 136,47 |
| M5705-B-5/8-SC | 2,21 | 165,54 |
| M5705-B-1 1/4-NP | 3,95 | 295,50 |
| M5705-B-1 1/8-NP | 3,80 | 284,40 |
| M5705-B-1-NP | 3,91 | 292,74 |
| M5705-B-3/4-NP | 2,81 | 210,36 |
| M5705-B-5/8-NP | 2,21 | 165,54 |
| M5706-B-1-SC | 3,88 | 290,55 |
| M5706-B-1-NP | 4,07 | 304,65 |
| M66415-B-32-SC | 3,53 | 264,60 |
| M66415-B-29-SC | 2,51 | 187,50 |
| M66415-B-25-SC | 2,68 | 200,46 |
| M66415-B-23-SC | 2,01 | 150,90 |
| M66415-B-18-SC | 1,73 | 129,87 |
| M66415-B-16-SC | 2,11 | 157,11 |
| M66415-B-14-SC | 1,60 | 119,22 |
| M66415-B-32-NP | 2,97 | 222,60 |
| M66415-B-29-NP | 3,99 | 298,80 |
| M66415-B-25-NP | 2,93 | 219,57 |
| M66415-B-23-NP | 1,72 | 128,28 |
| M66415-B-18-NP | 2,27 | 169,47 |
| M66415-B-16-NP | 2,32 | 173,70 |
| M66415-B-14-NP | 0,97 | 72,30 |

Seite/page 31

| Art.-Nr. | €/Stck | €/100 Stck |
|--------------|--------|------------|
| M1180-I-29 | 5,13 | 384,09 |
| M1180-I-25 | 3,07 | 229,20 |
| M1280-I-1 LW | 3,43 | 256,47 |
| M467-I-18x24 | 1,01 | 75,09 |
| M4960-I-40 | 1,55 | 115,95 |
| M4960-I-20 | 0,63 | 46,29 |
| M66510-I-25 | 1,88 | 140,40 |
| M66510-I-23 | 2,28 | 170,40 |
| M66510-I-20 | 1,96 | 146,73 |
| M66510-I-18 | 0,91 | 67,35 |
| M66510-I-16 | 1,39 | 103,05 |
| M66510-I-13 | 1,08 | 80,70 |
| M66510-I-10 | 0,71 | 52,44 |

#WERT! = Preis auf Anfrage

Alle Preise zzgl. MwSt.

Preisliste (EH)

- 8 -

| M1670-I-30 | 0,28 | 20,25 |
|---------------|--------|------------|
| Seite/page 32 | | |
| Art.-Nr. | €/Stck | €/100 Stck |
| M212-P-50 | 1,53 | 114,03 |
| M212-P-40 | 0,84 | 62,13 |
| M212-P-30 | 0,85 | 63,27 |
| M212-P-25 | 0,53 | 39,51 |
| M212-P-20 | 0,43 | 31,14 |
| M212-P-15 | 0,24 | 17,13 |
| M213-P-25 | 0,29 | 21,81 |
| M213-P-20 | 0,37 | 27,30 |
| M216-P-50 | 2,08 | 155,88 |
| M216-P-40 | 1,21 | 90,48 |
| M216-P-25 | 0,49 | 36,90 |
| M216-P-20 | 0,23 | 16,74 |
| M216-P-15 | 0,25 | 18,60 |
| M219-P-25 | 0,64 | 47,04 |
| M219-P-20 | 0,44 | 32,85 |
| M219-P-15 | 0,37 | 27,81 |
| M219-P-10 | 0,32 | 23,25 |
| M220-P-12 | 0,41 | 30,60 |
| M221-P-20 | 0,20 | 14,70 |
| M214-P-25 | 0,15 | 10,80 |

| Seite/page 33 | | |
|---------------|--------|------------|
| Art.-Nr. | €/Stck | €/100 Stck |
| M215-P-50 | 0,36 | 26,94 |
| M215-P-40 | 0,24 | 17,43 |
| M215-P-30 | 0,15 | 10,71 |
| M215-P-25 | 0,12 | 8,25 |
| M215-P-20 | 0,13 | 9,06 |
| M215-P-16 | 0,09 | 6,60 |
| M215-P-12 | 0,08 | 5,63 |
| M217-P-25 | 0,11 | 7,65 |
| M217-P-20 | 0,12 | 8,82 |
| M217-P-16 | 0,13 | 9,69 |
| M217-P-10 | 0,11 | 7,28 |
| M257-P-50 | 0,36 | 26,70 |
| M257-P-30 | 0,13 | 9,90 |
| M257-P-25 | 0,09 | 6,98 |
| M257-P-20 | 0,09 | 6,23 |
| M2570-P-25 | 0,12 | 8,33 |
| M2570-P-20 | 0,12 | 8,22 |
| M2570-P-16 | 0,11 | 7,69 |

| Seite/page 34 | | |
|---------------|--------|------------|
| Art.-Nr. | €/Stck | €/100 Stck |
| M216-16-ZP | 5,55 | 415,20 |
| M214-14-ZP | 3,31 | 247,05 |
| M212-12-ZP | 1,97 | 147,45 |
| M210-10-ZP | 1,21 | 90,90 |
| M208-8-ZP | 0,76 | 56,85 |
| M207-7-ZP | 0,59 | 43,20 |
| M206-6-ZP | 0,47 | 34,05 |
| M205-5-ZP | 0,35 | 25,80 |
| M204-4-ZP | 0,28 | 20,85 |
| M203-3,5-ZP | 0,25 | 18,45 |

| | | |
|-------------|--------|--------|
| M208-A-8-ZP | 1,08 | 80,25 |
| M206-A-6-ZP | 0,56 | 42,00 |
| M205-A-5-ZP | 0,48 | 35,85 |
| M204-A-4-ZP | #WERT! | #WERT! |
| M89-12-ZP | 1,28 | 95,85 |
| M89-10-ZP | 0,61 | 45,60 |
| M89-9-ZP | 0,68 | 50,94 |
| M89-8-ZP | 0,57 | 42,60 |
| M89-7-ZP | 0,44 | 32,70 |
| M89-6,5-ZP | #WERT! | #WERT! |
| M89-6-ZP | 0,71 | 52,32 |
| M89-5,5-ZP | 0,23 | 16,80 |
| M89-5-ZP | 0,17 | 12,45 |
| M89-4,5-ZP | 0,16 | 12,00 |
| M89-4-ZP | 0,12 | 8,70 |
| M89-3,5-ZP | 0,21 | 15,75 |
| M89-3-ZP | 0,12 | 8,63 |
| M90-10-ZP | 1,03 | 76,50 |
| M90-8-ZP | 0,53 | 39,30 |
| M90-7-ZP | 0,35 | 25,50 |
| M90-6-ZP | 0,29 | 21,63 |
| M90-5-ZP | 0,13 | 9,30 |
| M90-4,5-ZP | 0,13 | 9,90 |
| M90-4-ZP | 0,11 | 7,50 |
| M90-3,5-ZP | 0,13 | 9,19 |
| M90-3-ZP | 0,12 | 8,44 |
| M90-2,5-ZP | 0,11 | 7,88 |

| Seite/page 35 | | |
|---------------|--------|------------|
| Art.-Nr. | €/Stck | €/100 Stck |
| M212-I-12 | 16,71 | 1252,95 |
| M210-I-10 | 10,24 | 768,00 |
| M208-I-8 | 5,36 | 401,10 |
| M206-I-6 | 3,72 | 278,40 |
| M205-I-5 | 2,95 | 220,35 |
| M204-I-4 | 2,41 | 180,45 |
| M89-I-6 | #WERT! | #WERT! |
| M89-I-5 | #WERT! | #WERT! |
| M89-I-4 | #WERT! | #WERT! |
| M90-I-6 | #WERT! | #WERT! |
| M90-I-5 | 1,16 | 86,04 |
| M90-I-4 | 0,67 | 49,38 |
| M90-I-3 | 0,39 | 28,86 |
| M900-I-140 | 1,83 | 136,35 |
| M900-I-120 | 1,63 | 121,20 |
| M900-I-100 | 1,03 | 76,95 |
| M900-I-80 | 0,96 | 72,00 |

#WERT! = Preis auf Anfrage

Alle Preise zzgl. MwSt.

| Seite/page 36 | | |
|-----------------|--------|------------|
| Art.-Nr. | €/Stck | €/100 Stck |
| M500-25-1-ZP | 14,80 | 1110,00 |
| M500-22-7/8-ZP | #WERT! | #WERT! |
| M500-19-3/4-ZP | #WERT! | #WERT! |
| M500-16-5/8-ZP | #WERT! | #WERT! |
| M500-14-9/16-ZP | #WERT! | #WERT! |
| M500-12-1/2-ZP | #WERT! | #WERT! |
| M500-11-7/16-ZP | #WERT! | #WERT! |
| M500-10-3/8-ZP | 0,84 | 63,00 |
| M500-8-5/16-ZP | #WERT! | #WERT! |
| M500-6-1/4-ZP | #WERT! | #WERT! |
| M500-5-3/16-ZP | 0,44 | 32,01 |
| M600-25-1-ZP | 16,83 | 1261,44 |
| M600-22-7/8-ZP | #WERT! | #WERT! |
| M600-19-3/4-ZP | 3,23 | 241,65 |
| M600-16-5/8-ZP | #WERT! | #WERT! |
| M600-14-9/16-ZP | #WERT! | #WERT! |
| M600-12-1/2-ZP | #WERT! | #WERT! |
| M600-11-7/16-ZP | #WERT! | #WERT! |
| M600-10-3/8-ZP | 1,16 | 86,88 |
| M600-8-5/16-ZP | #WERT! | #WERT! |
| M600-6-1/4-ZP | 0,44 | 32,22 |
| M600-5-3/16-ZP | 0,35 | 25,68 |
| M700-13,5 | #WERT! | #WERT! |
| M700-12,0 | #WERT! | #WERT! |
| M700-9,5 | #WERT! | #WERT! |
| M700-8,5 | #WERT! | #WERT! |
| M700-6,5 | #WERT! | #WERT! |
| M700-4,75 | #WERT! | #WERT! |
| M700-3,25 | 10,08 | 755,19 |
| M700-2,0 | #WERT! | #WERT! |
| M700-1,5 | #WERT! | #WERT! |
| M700-1,0 | #WERT! | #WERT! |
| M700-0,75 | #WERT! | #WERT! |
| M700-0,5 | #WERT! | #WERT! |
| M701-13,5 | #WERT! | #WERT! |
| M701-12,0 | #WERT! | #WERT! |
| M701-9,5 | #WERT! | #WERT! |
| M701-8,5 | #WERT! | #WERT! |
| M701-6,5 | #WERT! | #WERT! |
| M701-4,75 | #WERT! | #WERT! |
| M701-3,25 | #WERT! | #WERT! |
| M701-2,0 | #WERT! | #WERT! |
| M701-1,5 | #WERT! | #WERT! |
| M701-1,0 | #WERT! | #WERT! |
| M701-0,75 | #WERT! | #WERT! |
| M701-0,5 | #WERT! | #WERT! |
| Seite/page 37 | | |
| Art.-Nr. | €/Stck | €/100 Stck |
| M82101-A-8,0 | 138,63 | 10396,95 |
| M82101-A-6,0 | 49,24 | 3692,10 |
| M82101-A-5,0 | 36,31 | 2722,35 |
| M82101-A-4,0 | 21,37 | 1602,45 |
| M82101-A-3,0 | 15,69 | 1176,15 |
| M82101-A-2,5 | 10,07 | 754,35 |

| | | |
|---------------|------|--------|
| M82101-A-2,0 | 8,19 | 613,80 |
| M82101-A-1,6 | 4,95 | 370,20 |
| M82101-A-1,0 | 3,13 | 234,30 |
| M82101-A-0,6 | 1,76 | 131,25 |
| M82101-A-0,4 | 1,25 | 93,75 |
| M82101-A-0,25 | 0,76 | 56,25 |
| M82101-A-0,16 | 0,57 | 42,30 |
| M82101-A-0,1 | 0,51 | 37,50 |

| Seite/page 39 | | |
|---------------|--------|------------|
| Art.-Nr. | €/Stck | €/100 Stck |
| M500-I-16 | 31,77 | 2382,24 |
| M500-I-12 | 10,76 | 806,22 |
| M500-I-10 | 8,00 | 599,58 |
| M500-I-8 | 4,57 | 342,63 |
| M500-I-6 | 2,71 | 202,71 |
| M500-I-5 | 1,93 | 144,99 |
| M500-I-4 | 1,77 | 132,60 |
| M600-I-12 | 9,73 | 729,63 |
| M600-I-10 | 11,11 | 832,77 |
| M600-I-8 | 6,41 | 480,63 |
| M600-I-6 | 2,71 | 202,86 |
| M600-I-5 | 2,56 | 191,94 |
| M600-I-4 | 2,05 | 153,69 |
| M66526-I-128 | 28,81 | 2160,66 |
| M66526-I-90 | 15,47 | 1159,92 |

| Seite/page 38 | | |
|-------------------|--------|------------|
| Art.-Nr. | €/Stck | €/100 Stck |
| M40-4x30-NP | 9,17 | 687,15 |
| M40-4x20-NP | 8,64 | 647,82 |
| M40-4x30-BP | 9,71 | 727,47 |
| M42-3,5x200-NP | 1,97 | 147,75 |
| M42-2,5x200-NP | 2,76 | 206,19 |
| M42-2x120-NP | 1,56 | 116,70 |
| M7115-5025-NP | 4,61 | 345,45 |
| M7115-5579-NP | 4,60 | 344,94 |
| M7116-30-CP | 7,85 | 588,45 |
| M7116-18-CP | 5,07 | 379,02 |
| M7116-16-CP | 7,85 | 588,45 |
| M9490-140-ZP | 24,89 | 1866,30 |
| M9490-90-ZP | 16,35 | 1225,20 |
| M9490-70-ZP | 15,69 | 1176,18 |
| M9490-55-ZP | 13,59 | 1018,50 |
| M9561-3x800-CP | #WERT! | #WERT! |
| M9561-3x600-CP | 6,09 | 456,75 |
| M9561-2x1000-CP | #WERT! | #WERT! |
| M9561-2x400-CP | 2,36 | 176,40 |
| M9561-1,6x1000-CP | 3,79 | 283,35 |
| M9562-3x600-CP | 4,20 | 314,22 |
| M9590-3/4-NP | 1,39 | 103,20 |

| Seite/page 39 | | |
|---------------|--------|------------|
| Art.-Nr. | €/Stck | €/100 Stck |
| M66527-I-114 | #WERT! | #WERT! |

#WERT! = Preis auf Anfrage

Alle Preise zzgl. MwSt.

Preisliste (EH)

- 10 -

| Seite/page 40 | | |
|-----------------|--------|------------|
| Art.-Nr. | €/Stck | €/100 Stck |
| M103-8-ZP | 0,52 | 38,70 |
| M103-6-ZP | 0,40 | 29,10 |
| M103-5-ZP | 0,17 | 12,60 |
| M103-4-ZP | 0,13 | 9,90 |
| M103-3-ZP | 0,12 | 8,63 |
| M103-2-ZP | 0,13 | 9,63 |
| M104-8-ZP | 0,95 | 70,05 |
| M104-6-ZP | 0,68 | 50,10 |
| M104-5-ZP | 0,36 | 26,40 |
| M104-4-ZP | 0,28 | 20,55 |
| M104-3-ZP | 0,27 | 19,50 |
| M104-2-ZP | 0,17 | 12,75 |
| M1142-30-ZP | 11,72 | 878,55 |
| M1142-26-ZP | 10,12 | 758,25 |
| M1142-22-ZP | #WERT! | #WERT! |
| M1142-19-ZP | 3,77 | 282,45 |
| M1142-16-ZP | 3,49 | 261,60 |
| M1142-13-ZP | 1,35 | 100,95 |
| M1142-10-ZP | 0,53 | 39,75 |
| M1142-8-ZP | 0,48 | 35,25 |
| M1142-6,5-ZP | 0,21 | 15,45 |
| M1142-5-ZP | 0,19 | 13,35 |
| M400-25-1-ZP | 1,77 | 132,15 |
| M400-22-7/8-ZP | 1,48 | 110,25 |
| M400-19-3/4-ZP | 0,97 | 72,75 |
| M400-16-5/8-ZP | 0,88 | 65,55 |
| M400-14-9/16-ZP | 0,60 | 44,67 |
| M400-12-1/2-ZP | 0,79 | 58,71 |
| M400-11-7/16-ZP | 0,32 | 24,00 |
| M400-10-3/8-ZP | 0,31 | 22,50 |
| M400-8-5/16-ZP | 0,19 | 13,05 |
| M400-6-1/4-ZP | 0,13 | 9,75 |
| M400-5-3/16-ZP | 0,12 | 9,00 |
| M400-3-1/8-ZP | 0,11 | 7,50 |
| M450-6-ZP | 1,79 | 133,35 |
| M450-5-ZP | 1,51 | 112,50 |
| M450-4-ZP | 1,36 | 102,00 |
| M450-3-ZP | 0,75 | 55,65 |
| M450-2-ZP | 0,71 | 52,20 |

| Seite/page 41 | | |
|---------------|--------|------------|
| Art.-Nr. | €/Stck | €/100 Stck |
| M1020-M10x80 | 2,68 | 201,00 |
| M1020-M8x110 | 3,09 | 231,60 |
| M1020-M8x70 | 1,95 | 145,35 |
| M1020-M6x100 | 1,95 | 145,05 |
| M1020-M6x60 | 1,36 | 101,85 |
| M1020-M5x70 | 1,20 | 89,55 |
| M1020-M5x50 | 1,12 | 83,40 |
| M1480-M30 | 39,55 | 2965,95 |
| M1480-M24 | 26,49 | 1986,75 |
| M1480-M20 | 17,31 | 1297,02 |
| M1480-M16 | 6,88 | 515,40 |
| M1480-M14 | 6,28 | 470,70 |
| M1480-M12 | 3,08 | 230,55 |

| | | |
|---------------|-------|---------|
| M1480-M10 | 2,20 | 165,00 |
| M1480-M8 | 1,53 | 114,90 |
| M1480-M6 | 1,23 | 91,50 |
| M3011-Z-M16 | 16,80 | 1259,55 |
| M3011-Z-M12 | 8,73 | 654,48 |
| M3011-Z-M10 | 6,80 | 509,07 |
| M3011-Z-M8 | 5,13 | 384,27 |
| M3011-Z-M6 | 4,79 | 358,50 |
| M15315 NG5-ZP | 5,76 | 431,10 |

| Seite/page 42 | | |
|---------------|--------|------------|
| Art.-Nr. | €/Stck | €/100 Stck |
| M840-20-ZP | 3,12 | 233,16 |
| M840-18-ZP | 2,32 | 173,79 |
| M840-16-ZP | 0,95 | 70,95 |
| M840-14-ZP | 0,63 | 46,35 |
| M840-12-ZP | 0,63 | 46,83 |
| M840-10-ZP | 0,33 | 24,15 |
| M840-8-ZP | 0,25 | 18,75 |
| M840-7-ZP | 0,23 | 16,35 |
| M840-6-ZP | 0,15 | 10,44 |
| M840-5-ZP | 0,15 | 10,05 |
| M840-4-ZP | 0,12 | 8,43 |
| M840-3-ZP | 0,12 | 8,10 |
| M842-20-ZP | #WERT! | #WERT! |
| M842-18-ZP | 4,45 | 333,75 |
| M842-16-ZP | 1,07 | 79,05 |
| M842-14-ZP | #WERT! | #WERT! |
| M842-12-ZP | 1,12 | 83,55 |
| M842-10-ZP | 0,72 | 53,55 |
| M842-8-ZP | 0,23 | 16,05 |
| M842-6-ZP | 0,20 | 14,70 |
| M842-5-ZP | 0,17 | 12,75 |
| M842-4-ZP | 0,16 | 11,25 |
| M842-3-ZP | 0,13 | 9,75 |
| M3A-10x100-ZP | 3,00 | 224,70 |
| M3A-9x90-ZP | 2,19 | 163,05 |
| M3A-8x80-ZP | 0,72 | 53,70 |
| M3A-7x75-ZP | 0,52 | 38,10 |
| M3A-6x70-ZP | 0,43 | 31,35 |
| M3A-6x60-ZP | #WERT! | #WERT! |
| M3093-14 | 2,61 | 195,90 |
| M3093-12 | 1,87 | 139,65 |
| M3093-11 | 1,55 | 115,05 |
| M3093-10 | 1,15 | 85,95 |
| M3093-8 | 0,65 | 48,75 |
| M3093-6 | 0,44 | 32,67 |
| M3093-5 | 0,40 | 29,40 |
| M3093-4 | 0,16 | 11,04 |
| M3093-3 | 0,16 | 11,70 |
| M3093-2 | 0,15 | 10,20 |
| M3093-1,5 | 0,13 | 9,45 |

#WERT! = Preis auf Anfrage

Alle Preise zzgl. MwSt.

Preisliste (EH)

- 11 -

| Seite/page 43 | | |
|---------------|--------|------------|
| Art.-Nr. | €/Stck | €/100 Stck |
| M103-I-8 | 5,05 | 378,45 |
| M103-I-6 | 2,88 | 215,40 |
| M103-I-5 | 2,00 | 149,10 |
| M103-I-4 | 1,44 | 107,25 |
| M103-I-3 | 0,91 | 67,95 |
| M103-I-2 | 0,77 | 57,75 |
| M104-I-8 | 9,45 | 708,60 |
| M104-I-6 | 5,36 | 401,55 |
| M104-I-5 | 3,24 | 243,00 |
| M104-I-4 | 2,41 | 180,90 |
| M104-I-3 | 1,35 | 100,95 |
| M104-I-2 | 1,27 | 94,65 |
| M400-I-16 | #WERT! | #WERT! |
| M400-I-12 | #WERT! | #WERT! |
| M400-I-10 | #WERT! | #WERT! |
| M400-I-8 | 4,72 | 353,40 |
| M400-I-6 | 2,00 | 149,85 |
| M400-I-5 | 1,69 | 126,18 |
| M400-I-4 | 2,32 | 173,85 |
| M400-I-3 | 2,17 | 162,60 |
| M400-I-2 | 2,04 | 153,00 |
| M3010-I-16 | 78,20 | 5864,25 |
| M3010-I-12 | 46,29 | 3471,30 |
| M3010-I-10 | 25,73 | 1929,15 |
| M3010-I-8 | 16,77 | 1257,30 |
| M3010-I-6 | 8,57 | 642,90 |
| M3010-I-5 | 6,72 | 503,70 |
| M3011-I-16 | 153,96 | 11546,25 |
| M3011-I-12 | 72,67 | 5449,95 |
| M3011-I-10 | 36,57 | 2742,30 |
| M3011-I-8 | 25,95 | 1945,35 |
| M3011-I-6 | 17,49 | 1311,60 |
| M3011-I-5 | 15,07 | 1129,50 |
| M844-I-8 | 1,44 | 107,10 |
| M844-I-6 | 0,64 | 47,04 |
| M844-I-5 | 0,51 | 37,23 |
| M844-I-4 | 0,47 | 34,50 |
| M844-I-3 | 0,37 | 27,90 |
| M844-I-2 | 0,35 | 25,95 |
| Seite/page 44 | | |
| Art.-Nr. | €/Stck | €/100 Stck |
| M163-11x13-NP | 1,04 | 77,40 |
| M163-9x16-NP | 1,04 | 77,40 |
| M163-9x13-NP | 0,95 | 70,35 |
| M166-80-NP | 2,17 | 162,60 |
| M166-70-NP | 1,47 | 109,80 |
| M166-60-NP | 1,11 | 82,05 |
| M166-45-NP | 0,89 | 66,60 |
| M166-30-NP | 0,72 | 53,10 |
| M166-80-SC | 1,92 | 143,85 |
| M166-70-SC | #WERT! | #WERT! |
| M166-60-SC | 0,97 | 72,90 |
| M166-45-SC | #WERT! | #WERT! |

| | | |
|----------------|--------|--------|
| M420-100 | 1,11 | 82,05 |
| M420-90 | 1,03 | 76,05 |
| M420-80 | 0,89 | 66,60 |
| M173-Z-1-NP | 1,69 | 126,81 |
| M173-Z-7/8-NP | 1,00 | 74,31 |
| M173-Z-3/4-NP | 1,29 | 96,99 |
| M173-Z-5/8-NP | #WERT! | #WERT! |
| M175-Z-1-NP | 1,49 | 111,03 |
| M175-Z-3/4-NP | 1,19 | 88,32 |
| M175-Z-5/8-NP | 1,23 | 91,05 |
| M175-Z-1/2-NP | 0,88 | 66,00 |
| M175-Z-3/8-NP | 0,76 | 56,64 |
| M7931-25x25-NP | 1,65 | 123,36 |
| M7931-25x20-NP | 1,65 | 123,30 |
| M7931-20x25-NP | 1,17 | 87,27 |
| M7931-20x20-NP | 1,35 | 100,95 |

| | | |
|---------------|------|--------|
| M167-B-90-SC | 5,53 | 414,60 |
| M167-B-50-SC | 6,35 | 475,50 |
| M178-B-5/8-SC | 4,29 | 321,51 |

| Seite/page 45 | | |
|---------------|--------|------------|
| Art.-Nr. | €/Stck | €/100 Stck |
| M7990-I-10 | 14,73 | 1104,96 |
| M7990-I-8 | 8,89 | 666,30 |
| M7990-I-6 | 4,17 | 312,21 |
| M7990-I-5 | 3,65 | 273,33 |
| M7992-I-10 | #WERT! | #WERT! |

| Seite/page 46 | | |
|---------------|--------|------------|
| Art.-Nr. | €/Stck | €/100 Stck |
| M502-50-ZP | 7,76 | 582,00 |
| M502-40-ZP | 4,96 | 372,00 |
| M502-30-ZP | 3,81 | 285,15 |
| M502-25-ZP | 2,01 | 150,06 |
| M502-20-ZP | 2,40 | 179,10 |
| M502-15-ZP | 1,29 | 96,15 |
| M503-30-ZP | #WERT! | #WERT! |
| M504-50-ZP | 12,05 | 903,60 |
| M504-40-ZP | 7,37 | 552,30 |
| M504-30-ZP | 5,83 | 436,65 |
| M504-25-ZP | 3,69 | 276,03 |
| M504-20-ZP | 3,03 | 226,95 |
| M504-15-ZP | 2,64 | 197,55 |
| M505-50-ZP | 10,69 | 801,30 |
| M505-40-ZP | 7,80 | 584,25 |
| M505-30-ZP | 3,16 | 237,00 |
| M505-25-ZP | 2,52 | 189,00 |
| M505-20-ZP | 3,25 | 243,60 |
| M505-15-ZP | 1,25 | 93,75 |
| M507-50-ZP | 2,80 | 209,10 |
| M507-30-ZP | 3,16 | 237,00 |
| M507-50GR-ZP | 2,76 | 206,70 |
| M507-30GR-ZP | 1,87 | 139,35 |

#WERT! = Preis auf Anfrage

Alle Preise zzgl. MwSt.

| Seite/page 47 | | |
|----------------|--------|------------|
| Art.-Nr. | €/Stck | €/100 Stck |
| M7310-1 1/2-NP | 7,35 | 550,65 |
| M7310-1-NP | 3,88 | 290,10 |
| M7320-1 1/2-NP | 12,20 | 915,00 |
| M7320-1-NP | 7,11 | 532,80 |
| M8310-1 1/4 | #WERT! | #WERT! |
| M8310-3/4 | #WERT! | #WERT! |

M8253-I-S #WERT! #WERT!

| Seite/page 48 | | |
|----------------|--------|------------|
| Art.-Nr. | €/Stck | €/100 Stck |
| M16-ST-5/8-ZP | 0,36 | 27,00 |
| M16-ST-1/2-NP | 0,28 | 20,25 |
| M4015-Z-153-NP | 2,09 | 156,45 |
| M4015-Z-112-NP | 1,32 | 98,55 |
| M4015-Z-62-NP | 0,51 | 37,65 |

M HRC B 7/8-SC 3,67 274,95

| Seite/page 49 | | |
|---------------|--------|------------|
| Art.-Nr. | €/Stck | €/100 Stck |
| M580-M24-ZP | 10,28 | 770,58 |
| M580-M20-ZP | 3,75 | 280,02 |
| M580-M16-ZP | 3,13 | 234,48 |
| M580-M14-ZP | 3,35 | 250,20 |
| M580-M12-ZP | 1,51 | 112,80 |
| M580-M10-ZP | 0,96 | 71,97 |
| M580-M8-ZP | 0,84 | 62,04 |
| M580-M6-ZP | 0,55 | 40,80 |
| M582-M24-ZP | 5,52 | 413,25 |
| M582-M20-ZP | 2,80 | 209,55 |
| M582-M16-ZP | 3,25 | 243,66 |
| M582-M14-ZP | #WERT! | #WERT! |
| M582-M12-ZP | 1,99 | 148,59 |
| M582-M10-ZP | 0,97 | 72,09 |
| M582-M8-ZP | 0,65 | 48,96 |
| M582-M6-ZP | 0,55 | 40,80 |

| | | |
|------------|-------|---------|
| M580-I-M12 | 16,25 | 1218,45 |
| M580-I-M10 | 11,51 | 862,95 |
| M580-I-M8 | 3,99 | 298,47 |
| M580-I-M6 | 6,63 | 496,80 |
| M582-I-M12 | 15,76 | 1181,85 |
| M582-I-M10 | 11,16 | 836,70 |
| M582-I-M8 | 6,43 | 481,20 |
| M582-I-M6 | 6,43 | 481,20 |

| Seite/page 50 | | |
|---------------|--------|------------|
| Art.-Nr. | €/Stck | €/100 Stck |
| M27H-ZP | 1,59 | 118,80 |
| M37H/C-4-ZP | 2,05 | 153,45 |
| M42A-130 HG | 6,52 | 489,00 |
| M42A-70 HG | 2,87 | 214,98 |

| | | |
|----------------|--------|--------|
| M42A-E/130EG | 7,68 | 576,00 |
| M42A-E/70 EG | #WERT! | #WERT! |
| M47-M8x120x15 | #WERT! | #WERT! |
| M47-M8x100x15 | #WERT! | #WERT! |
| M47-M8x80x15 | #WERT! | #WERT! |
| M48-M10x150x20 | #WERT! | #WERT! |
| M48-M10x100x20 | #WERT! | #WERT! |
| M48-M10x80x20 | #WERT! | #WERT! |
| M7-10,6x180 EG | #WERT! | #WERT! |
| M7-10,6x180 HG | #WERT! | #WERT! |
| M8-10,6x145 HG | #WERT! | #WERT! |
| M8-10,6x133 HG | #WERT! | #WERT! |
| M8-8,8x145 HG | #WERT! | #WERT! |
| M8-8,8x140 EG | #WERT! | #WERT! |
| M9-M8x180-ZP | #WERT! | #WERT! |
| M9-M8x160-ZP | #WERT! | #WERT! |
| M9-M8x140-ZP | #WERT! | #WERT! |
| M9-M8x120-ZP | #WERT! | #WERT! |
| M9-M8x100-ZP | #WERT! | #WERT! |
| M9-M8x80-ZP | #WERT! | #WERT! |
| M9-M8x60-ZP | #WERT! | #WERT! |
| M9491-ZP | 2,04 | 152,34 |

| Seite/page 51 | | |
|----------------|--------|------------|
| Art.-Nr. | €/Stck | €/100 Stck |
| M047-410x8-CP | 4,39 | 328,50 |
| M0848-7-NP | 1,01 | 75,27 |
| M1954-1-NP | 0,47 | 34,08 |
| M1954-3/4-NP | 0,32 | 23,73 |
| M1954-3/4k-NP | 0,23 | 16,38 |
| M1954-5/8-NP | 0,25 | 18,30 |
| M315-M12-ZP | 0,40 | 29,70 |
| M315-M10-ZP | 0,29 | 21,15 |
| M315-M8-ZP | 0,19 | 13,65 |
| M315-M6-ZP | 0,16 | 11,85 |
| M315-M5-ZP | 0,12 | 8,81 |
| M315-M4-ZP | 0,07 | 4,31 |
| M315-M3-ZP | 0,09 | 6,38 |
| M465-ZP | 0,49 | 36,30 |
| M TZU-12080-ZP | 14,23 | 1066,05 |

| Seite/page 52 | | |
|---------------|--------|------------|
| Art.-Nr. | €/Stck | €/100 Stck |
| M10-2002-CP | 4,05 | 303,99 |
| M66431-40 | 1,89 | 141,30 |
| M66431-26 | 1,83 | 136,50 |
| M66431-20 | 0,99 | 73,50 |

| | | |
|-------------|--------|--------|
| M1954-I-3/4 | 1,40 | 104,76 |
| M66432-I-36 | #WERT! | #WERT! |
| M66432-I-30 | 2,49 | 186,93 |
| M66432-I-26 | 1,97 | 147,81 |
| M9-I-M8x180 | 3,08 | 230,10 |
| M9-I-M8x160 | 2,73 | 204,60 |
| M9-I-M8x140 | 2,40 | 179,10 |
| M9-I-M8x120 | 2,05 | 153,45 |
| M9-I-M8x100 | 1,71 | 127,95 |

#WERT! = Preis auf Anfrage

Alle Preise zzgl. MwSt.

| | | |
|------------|------|--------|
| M9-I-M8x80 | 1,37 | 102,45 |
| M9-I-M8x60 | 1,03 | 76,80 |

Seite/page 53

| Art.-Nr. | €/Stck | €/100 Stck |
|-------------------|--------|------------|
| M325-16x60-ZP | #WERT! | #WERT! |
| M325-10x60-ZP | 1,15 | 85,83 |
| M325-10x50-ZP26,3 | #WERT! | #WERT! |
| M325-8x60-ZP | 1,95 | 145,95 |
| M325-8x50-ZP | 1,21 | 90,30 |
| M325-8x45-ZP | #WERT! | #WERT! |
| M325-8x40-ZP | 1,29 | 96,30 |
| M325-6x45-ZP | 1,21 | 90,57 |
| M325-6x32-ZP | 0,97 | 72,18 |
| M325-4,5x40-ZP | 1,45 | 108,18 |
| M310-8-ZP | 1,60 | 119,25 |
| M310-6-ZP | 0,60 | 44,25 |
| M310-5-ZP | 0,39 | 28,47 |
| M310-4-ZP | 0,21 | 15,81 |
| M310-3-ZP | 0,15 | 10,11 |
| M310-2-ZP | 0,08 | 5,85 |
| M320-8-ZP | 2,32 | 173,85 |
| M320-6ZP | 1,01 | 75,45 |
| M320-5-ZP | 0,56 | 41,40 |
| M320-4-ZP | 0,32 | 23,73 |
| M320-3-ZP | 0,16 | 11,01 |
| M320-2-ZP | 0,11 | 7,50 |
| M330-12-ZP | 0,45 | 33,60 |
| M330-11-ZP | 0,43 | 31,95 |
| M330-10-ZP | 0,39 | 28,95 |
| M330-8-ZP | 0,36 | 26,55 |
| M330-6-ZP | 0,31 | 22,65 |
| M330-5,2-ZP | 1,05 | 78,90 |
| M330-4,5-ZP | 0,21 | 15,27 |

Seite/page 54

| Art.-Nr. | €/Stck | €/100 Stck |
|----------|--------|------------|
| M310-I-6 | 7,73 | 579,75 |
| M310-I-5 | 4,24 | 317,55 |
| M310-I-4 | 2,12 | 158,10 |
| M310-I-3 | 1,19 | 88,20 |
| M310-I-2 | 0,59 | 43,50 |

| | | |
|------------|------|--------|
| M514C-NP | 0,17 | 12,03 |
| M514CK-NP | 0,55 | 40,11 |
| M8500-5-SC | 0,31 | 22,35 |
| M8600-8-ZP | 1,69 | 126,60 |

#WERT! = Preis auf Anfrage

Alle Preise zzgl. MwSt.

Terms and conditions (this is a translation for better understanding only. The German worded AGB are valid!)

General

We are generally allowed to change and complete our terms and conditions. These are valid for all contracts, deliveries & Services. Trade Terms and conditions of customer companies, contradicting these, are unacknowledged by us. Special terms need our agreement in writing. Deliveries are based solely on our Terms and Conditions:

1. All prices are shown in € and generally excluding VAT. Exceptions, f.e. books, will be correctly priced. However, all prices in our **Online-shop** are including VAT. All prices shown cannot be guaranteed, prices are fixed on the deal. The availability of an article decides about the acceptance and conducting of an order. Minimal deliveries of under €35,- value will be charged an additional € 7,- cost for minimal orders. Samples excluded.
2. If not especially asked otherwise by the purchaser, deliveries are sent by a parcel carrier or freight hauler of our choice. Deliveries are generally at expense & risk of the purchaser. Wares will be insured by us at the expense of the purchaser.
3. Wares will be controlled by us for mistake avoidance, prior delivery. Should there be complaints about deliveries, we need a written complaint within 8 days after delivery. Later objections are invalid. Accepted complains will be exchanged immediately at no expense. Other demands are ruled out from the start.
4. Customer made items cannot be exchanged or returned.
5. Debts must be cleared and paid within the date shown on the invoice. Should an express date of payment be missing, goods must be paid within 10 days without Settlement Discount (skonto) of 3%. Late Payment will result in reserving our right to charge interest of at least 2% above current bank rate.
6. The property in any goods sold and delivered by us does not pass on the purchaser unless and until the full purchase price thereof is paid to us. This includes our right to reclaim unpaid goods. Not fully paid goods can't be leased, sold or given as debt clearing to a third party unless paid completely.
7. Deliveries to new purchasers will be paid for in advance, as well as online customers..
8. Place of fulfillment is Sehnde. Place of Jurisdiction is Lehrte near Hanover. German law presides over contractual relationship.
9. Should any part of these Terms & Conditions contradict valid German law, and be therefore invalid or outdated, it will not invalidate the other Terms & Conditions laid out above.
10. Due to § 28 of Bundesdatenschutzgesetzes (BDSG) (German Privacy law), we inform You that purchaser data needed to conduct business are worked on and stored via an electronic device § 33 (BDSG) (Computer). Personal Data will be stored securely and used confidentially.